



US00D794749S

(12) **United States Design Patent** (10) **Patent No.:** **US D794,749 S**  
**Zou** (45) **Date of Patent:** **\*\* Aug. 15, 2017**

(54) **WATER FILTER**  
(71) Applicant: **HONG KONG ECOAQUA CO., LIMITED**, Chai Wan (HK)  
(72) Inventor: **Zhibin Zou**, Qingdao (CN)  
(73) Assignee: **Hong Kong EcoAqua Co., Limited**, Hong Kong (HK)  
(\*\*) Term: **15 Years**  
(21) Appl. No.: **29/563,878**  
(22) Filed: **May 9, 2016**  
(51) **LOC (10) Cl.** ..... **23-01**  
(52) **U.S. Cl.**  
USPC ..... **D23/209**  
(58) **Field of Classification Search**  
USPC ..... D23/207, 209; 210/232–236  
CPC ..... B01D 35/30; B01D 35/153; C02F 1/003  
See application file for complete search history.

D728,069 S \* 4/2015 Moore ..... D23/209  
9,011,686 B2 \* 4/2015 Kirchner ..... B01D 35/153  
210/248  
D750,738 S \* 3/2016 Baird ..... D23/209  
D751,666 S \* 3/2016 Kruckenberg ..... B01D 35/30  
D23/209  
9,289,704 B2 \* 3/2016 Fisher ..... B01D 35/30  
D755,922 S \* 5/2016 Sherman ..... B01D 35/30  
D23/209  
D760,868 S \* 7/2016 Lu ..... D23/209  
D764,021 S \* 8/2016 Lu ..... D23/209  
D764,626 S \* 8/2016 Lu ..... D23/209  
D768,814 S \* 10/2016 Dong ..... D23/209  
9,469,551 B2 \* 10/2016 Sherman ..... C02F 1/003  
D773,607 S \* 12/2016 Lu ..... D23/209  
D776,237 S \* 1/2017 Dong ..... D23/207  
D780,887 S \* 3/2017 Huda ..... D23/209  
D784,492 S \* 4/2017 Lu ..... D23/209

\* cited by examiner

*Primary Examiner* — Robin V Webster  
(74) *Attorney, Agent, or Firm* — Schmeiser, Olsen & Watts, LLP

(57) **CLAIM**

The ornamental design for a water filter, as shown and described.

**DESCRIPTION**

FIG. 1 is a front elevational view of a water filter showing my new design;  
FIG. 2 is a rear elevational view thereof;  
FIG. 3 is a right side view thereof;  
FIG. 4 is a left side view thereof;  
FIG. 5 is a top plan view thereof;  
FIG. 6 is a bottom plan view thereof; and,  
FIG. 7 is a perspective view thereof.  
The broken lines in the drawing depict portions of the water filter that form no part of the claimed design.

**1 Claim, 7 Drawing Sheets**

(56) **References Cited**

**U.S. PATENT DOCUMENTS**

6,120,685 A \* 9/2000 Carlson ..... B01D 35/143  
210/232  
6,360,764 B1 \* 3/2002 Fritze ..... B01D 35/153  
137/15.01  
D472,604 S \* 4/2003 Fritze ..... D23/209  
D494,654 S \* 8/2004 Macaulay ..... D23/209  
D547,821 S \* 7/2007 Kennedy ..... D23/207  
D548,306 S \* 8/2007 Kennedy ..... D23/209  
D570,951 S \* 6/2008 Morita ..... D23/209  
D591,389 S \* 4/2009 Born ..... D23/209  
D599,880 S \* 9/2009 Rampen ..... D23/209  
7,744,757 B1 \* 6/2010 Liao ..... B01D 35/30  
210/232  
7,997,421 B2 \* 8/2011 Maurer ..... B01D 29/114  
210/440

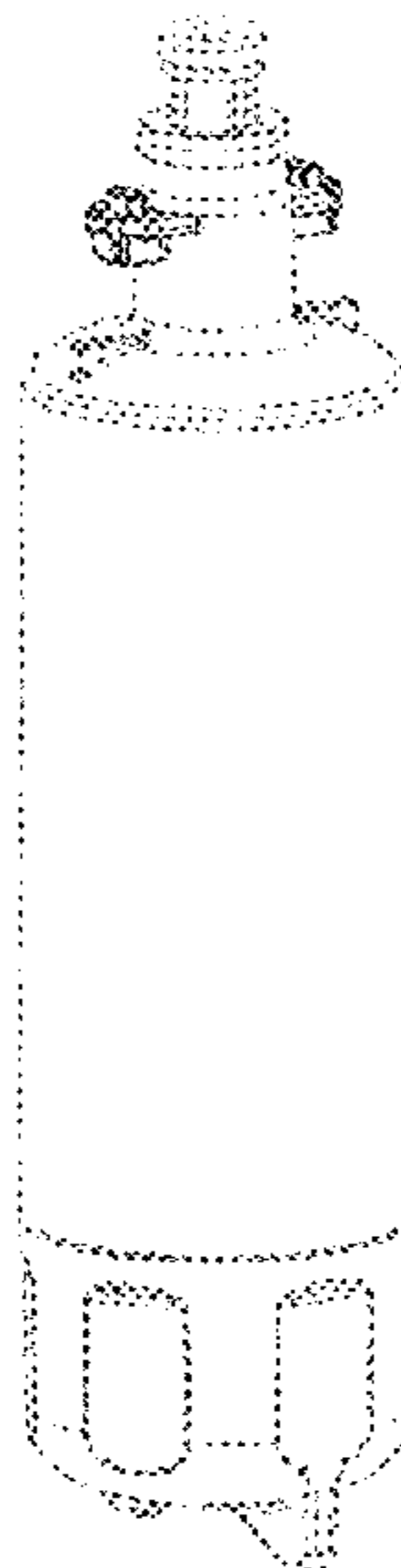

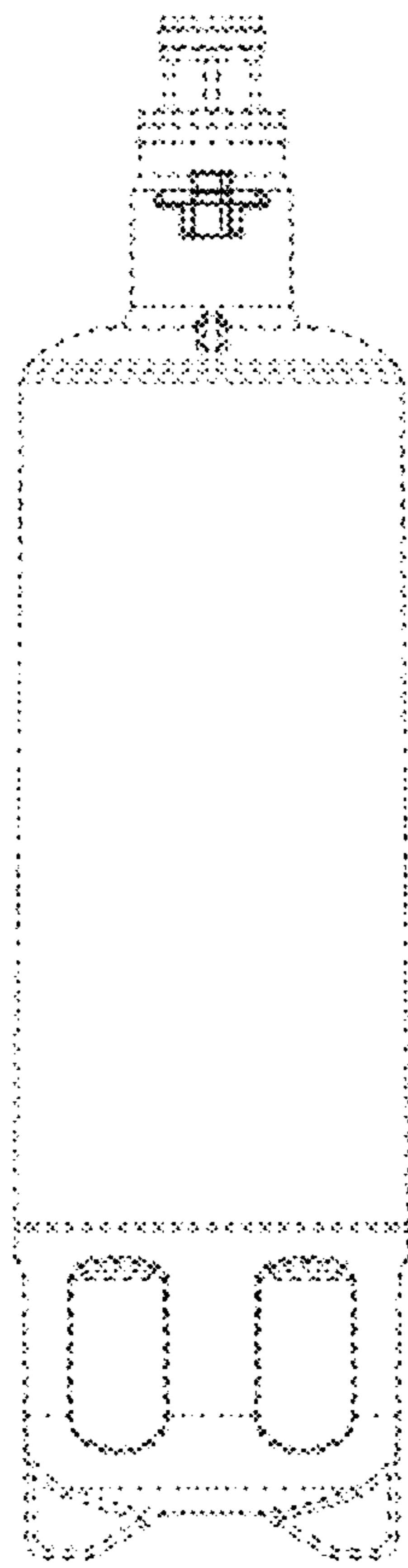

Figure 1

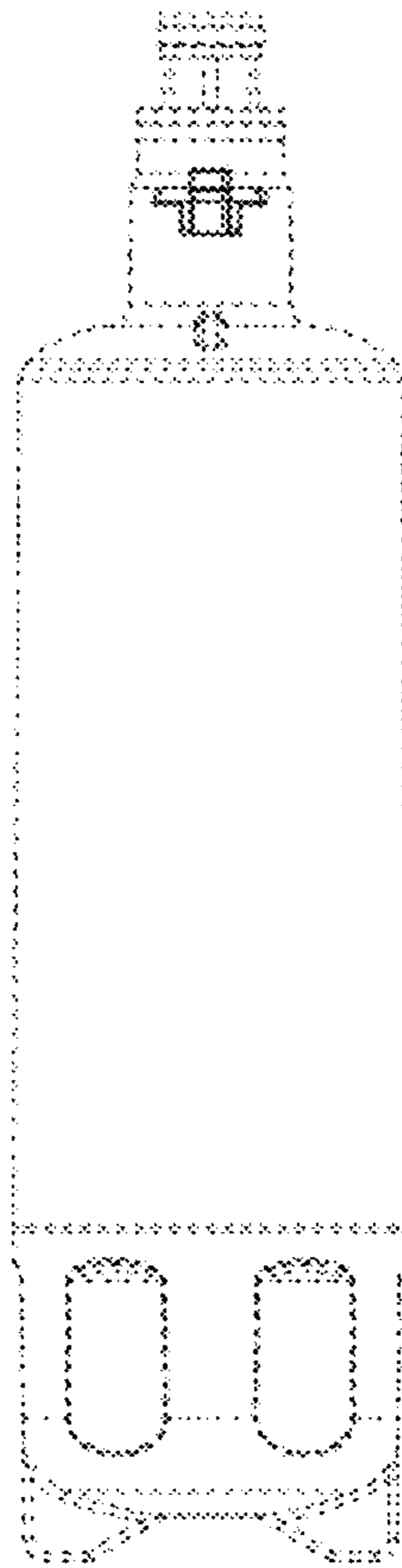

Figure 2

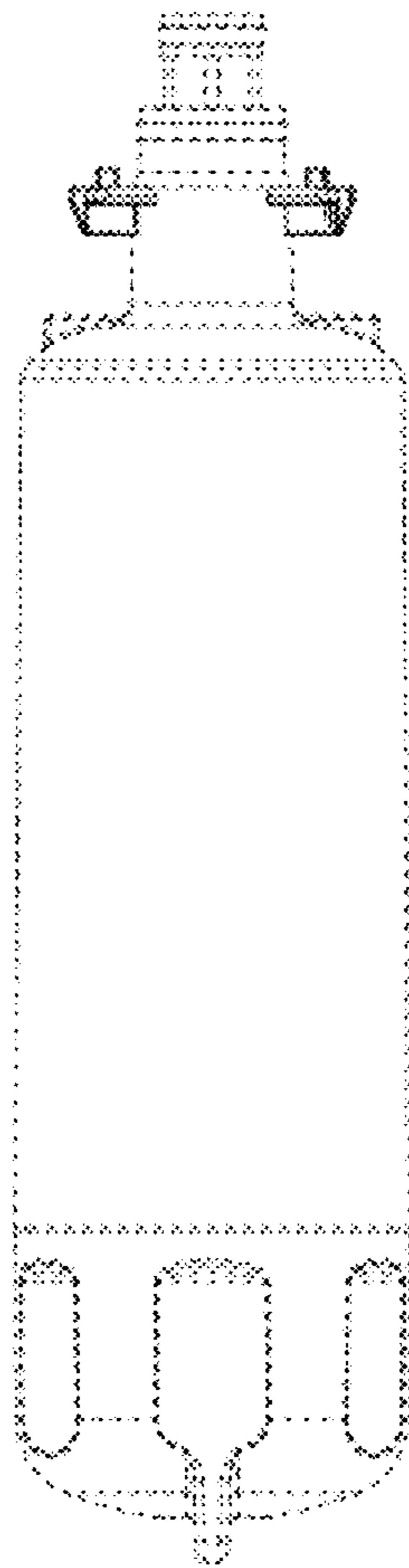

Figure 3

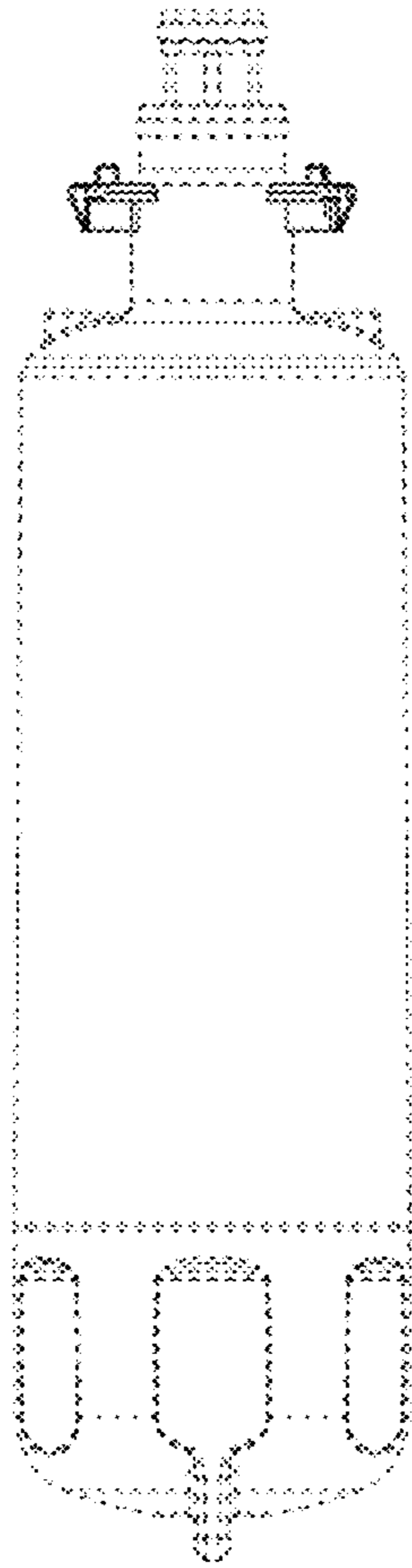

Figure 4

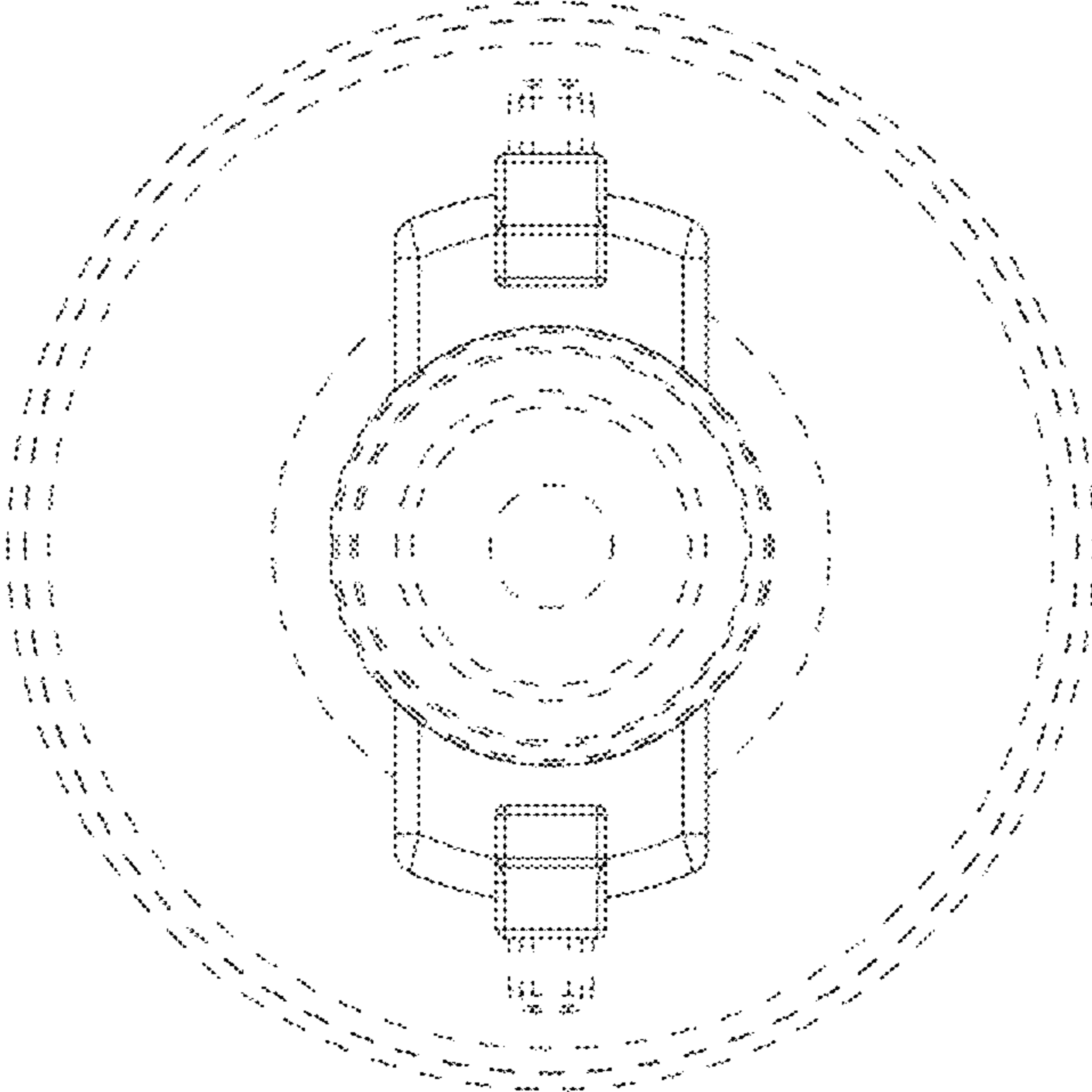

Figure 5

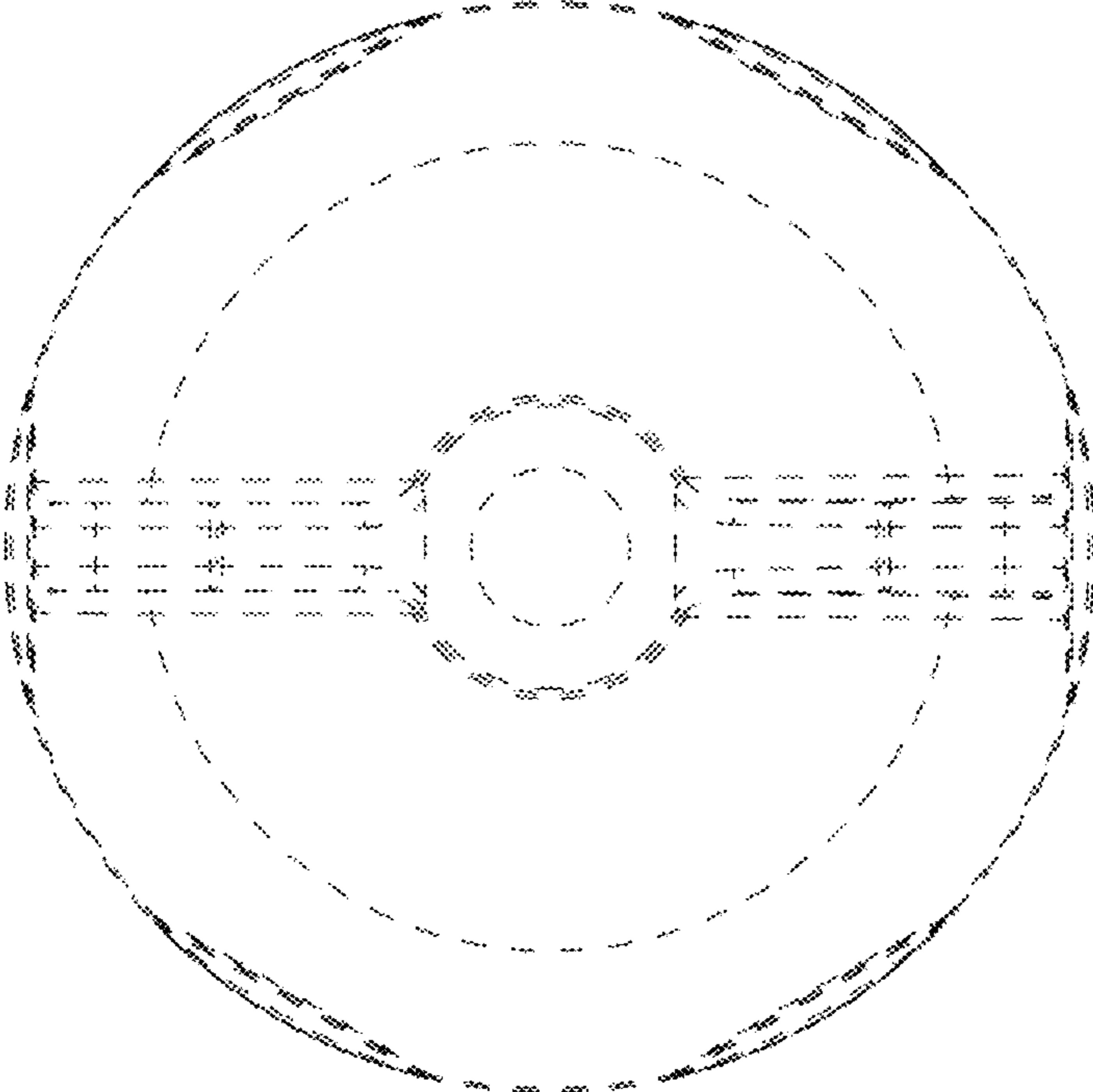

Figure 6

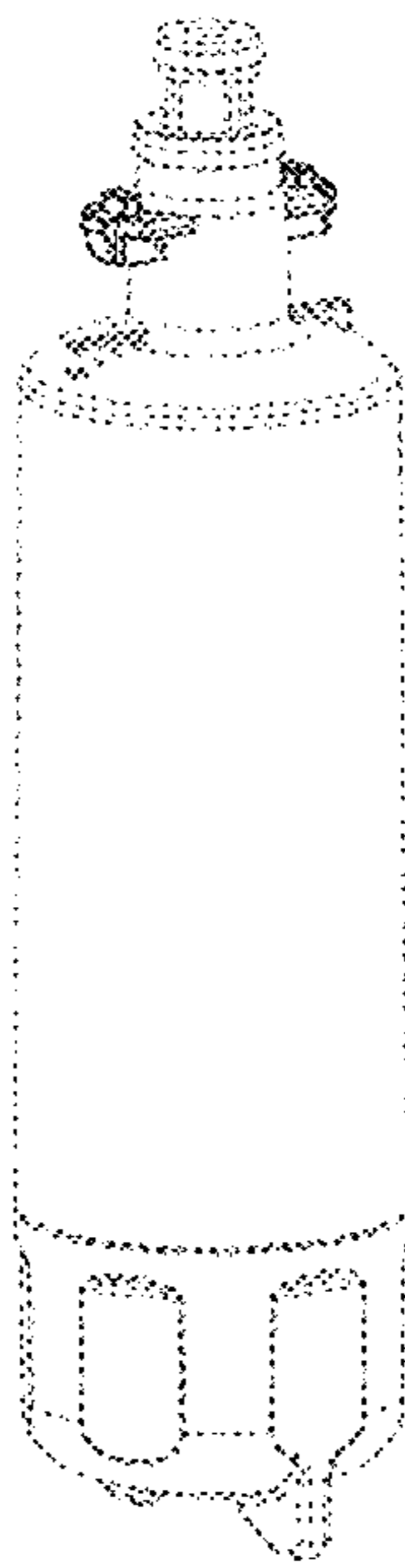

Figure 7