



US00D794741S

(12) **United States Design Patent** (10) **Patent No.:** **US D794,741 S**
Geissele (45) **Date of Patent:** **** Aug. 15, 2017**

- (54) **FIREARM CHARGING HANDLE**
- (71) Applicant: **WHG Properties, LLC**, North Wales, PA (US)
- (72) Inventor: **William H. Geissele**, Lower Gwynedd, PA (US)
- (73) Assignee: **WHG Properties LLC**, North Wales, PA (US)
- (**) Term: **15 Years**
- (21) Appl. No.: **29/575,946**
- (22) Filed: **Aug. 30, 2016**

D694,354 S 11/2013 Underwood
 D705,384 S 5/2014 Underwood
 8,820,210 B2 9/2014 Melville
 (Continued)

OTHER PUBLICATIONS

Primary Arms.com, Geissele Super Charging Handle, publication date unknown, [site visited Aug. 2, 2016], Available on the Internet URL<<http://www.primaryarms.com/05-313s/p/05-313s/>>.*
 (Continued)

Primary Examiner — Karen S Acker
Assistant Examiner — S. Bryan Reinholdt, Jr.
 (74) *Attorney, Agent, or Firm* — Merchant & Gould, P.C.

(57) **CLAIM**

The ornamental design for a firearm charging handle, as shown and described.

DESCRIPTION

FIG. 1 is a bottom, front, right side perspective view of a firearm charging handle according to the present disclosure; FIG. 2 is a bottom, front, right side perspective view of a rear portion of the firearm charging handle of FIG. 1; FIG. 3 is a top view of a rear portion of the firearm charging handle of FIG. 1; FIG. 4 is a bottom view of a rear portion of the firearm charging handle of FIG. 1; FIG. 5 is a right side view of a rear portion of the firearm charging handle of FIG. 1; FIG. 6 is a left side view of a rear portion of the firearm charging handle of FIG. 1; FIG. 7 is a rear view of a rear portion of the firearm charging handle of FIG. 1; and, FIG. 8 is a front view of a rear portion of the firearm charging handle of FIG. 1.
 The broken lines in the Figures illustrate portions of the firearm charging handle that form no part of the claimed design.

Related U.S. Application Data

- (62) Division of application No. 29/532,114, filed on Jul. 1, 2015, now Pat. No. Des. 772,369.
- (51) **LOC (10) Cl.** **22-01**
- (52) **U.S. Cl.**
USPC **D22/108**
- (58) **Field of Classification Search**
USPC D22/108, 199; D21/572-575
CPC F41A 3/72; F41A 3/26; F41A 7/00; F41A 7/02; F41A 9/38; F41A 3/18
See application file for complete search history.

References Cited

U.S. PATENT DOCUMENTS

7,240,600 B1	7/2007	Bordson	
7,832,322 B1	11/2010	Hoel	
7,861,635 B1 *	1/2011	Hoel F41A 3/20 42/16
7,900,546 B2	3/2011	Bordson	
8,104,393 B2	1/2012	Kincel	
8,261,649 B2	9/2012	Fitzpatrick	
8,336,436 B2	12/2012	Kincel	
8,356,537 B2	1/2013	Kincel	

1 Claim, 4 Drawing Sheets

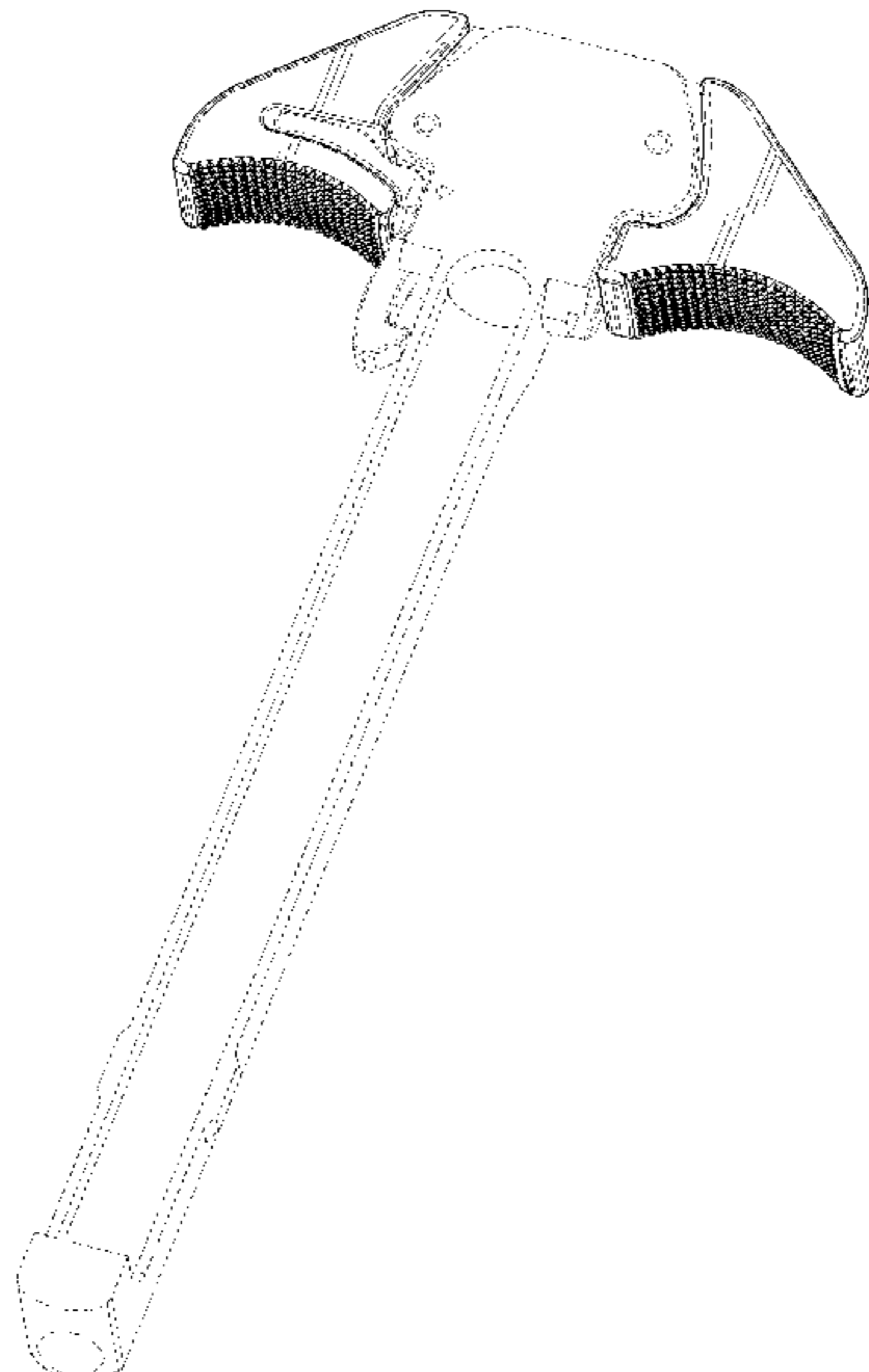

(56)

References Cited

U.S. PATENT DOCUMENTS

8,960,066 B2 2/2015 Gomez
D726,860 S * 4/2015 Underwood D22/108
D738,452 S * 9/2015 Underwood D22/108
D749,687 S * 2/2016 Warensford D22/108
9,366,489 B1 * 6/2016 Strom F41A 35/06
D772,369 S * 11/2016 Evans D22/108
D781,986 S * 3/2017 Green D22/108
D781,988 S * 3/2017 Geissele D22/108
9,587,896 B1 * 3/2017 Huang F41A 35/06
D787,624 S * 5/2017 Novak D22/108

OTHER PUBLICATIONS

MidwayUSA, Geissele Super Ambidextrous Charging Handle Assembly AR-15 Aluminum, publication date unknown, [site visited Aug. 2, 2016], Available on the Internet URL: <<http://www.midwayusa.com/product/2539201280/geissele-super-ambidextrous-charging-handle-assembly-ar-15-aluminum>>.*

AR15NEWS.COM available at <http://www.ar15news.com/2015/05/16/sneak-peek-rainier-arms-avalanche-ambi-charging-handle/> (May 22, 2015).

Highjack86, Rainier Arms Avalanche Ami Charging Handle—Preview/Initial Impressions (Jul. 16, 2015).

* cited by examiner

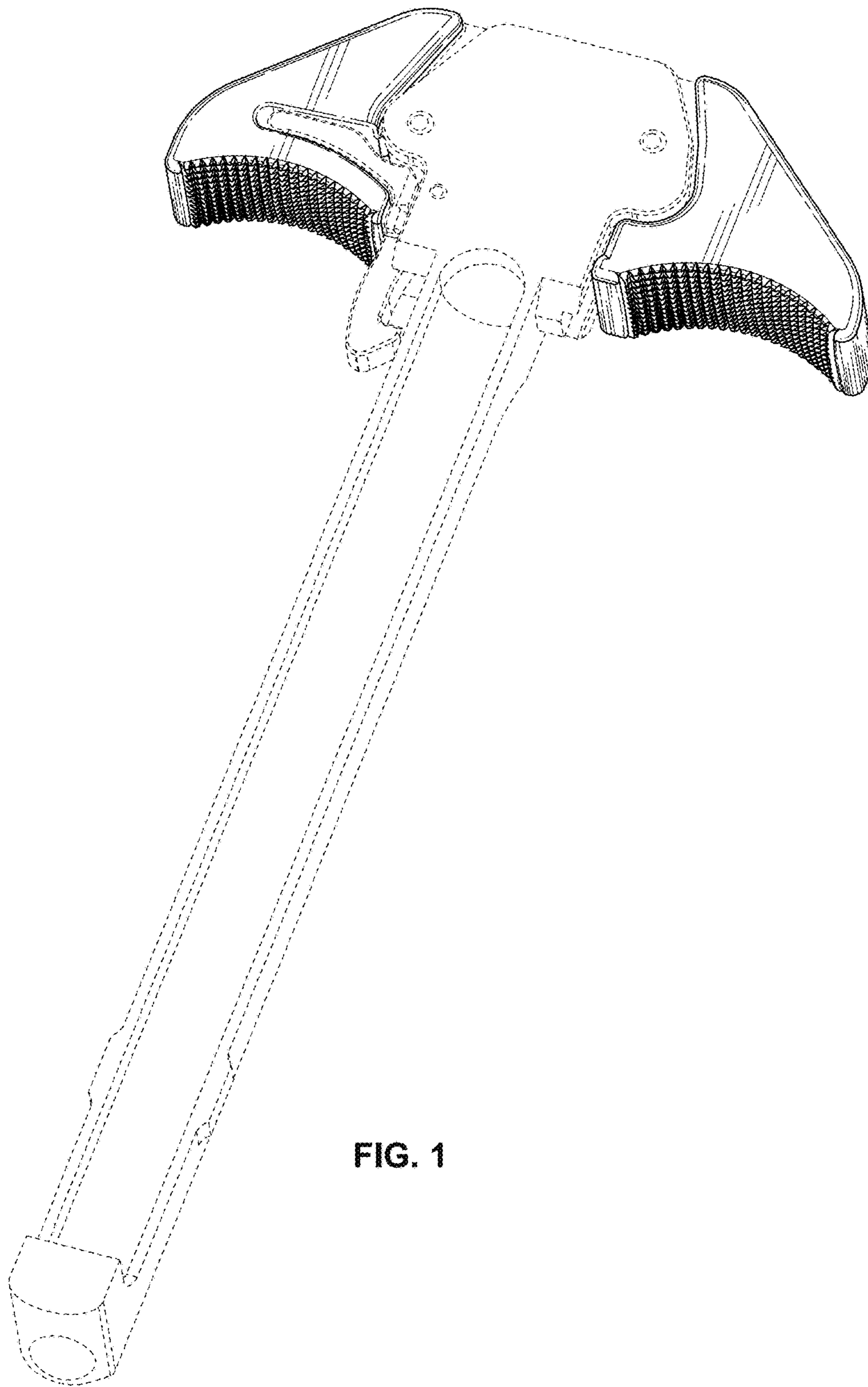

FIG. 1

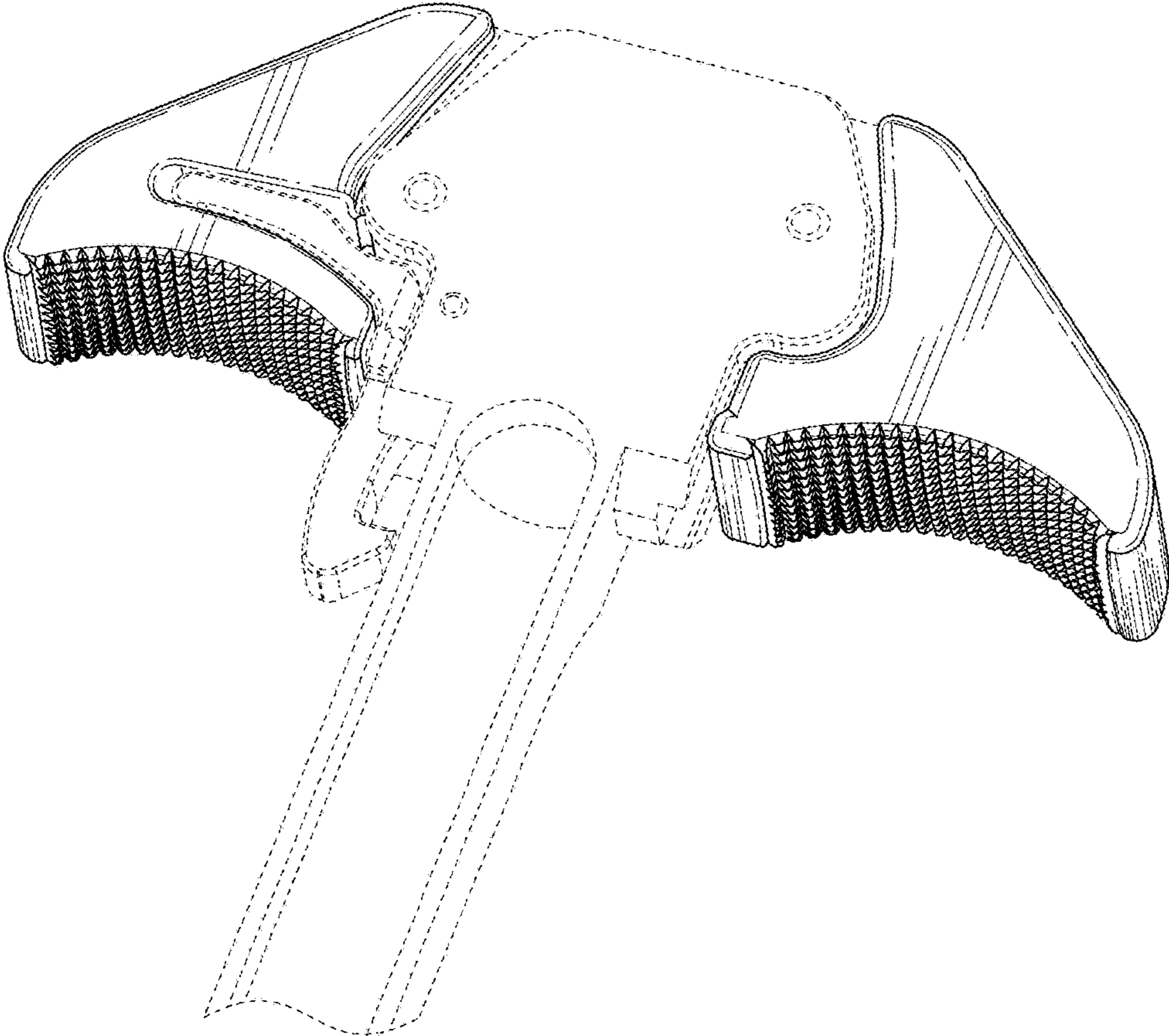

FIG. 2

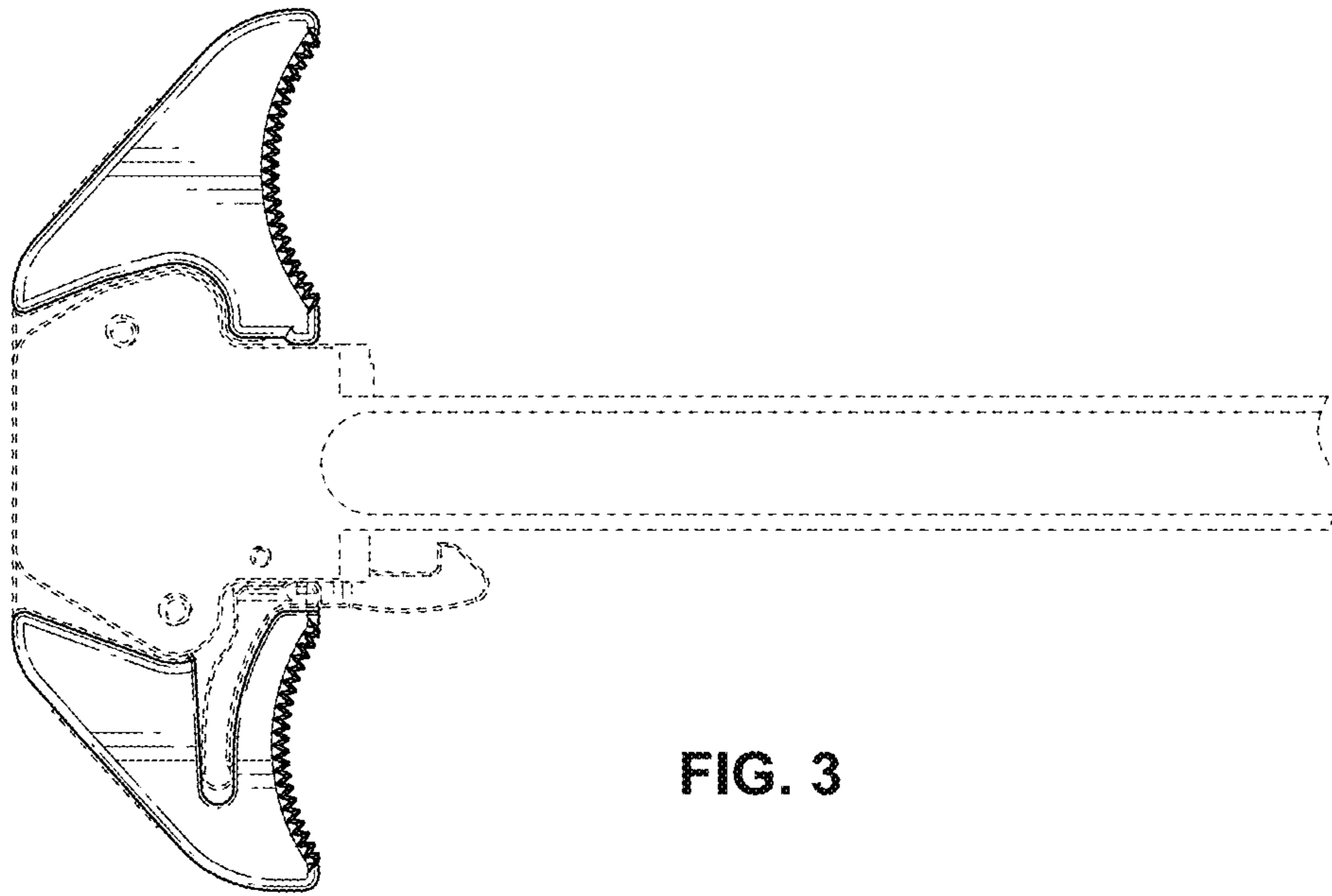

FIG. 3

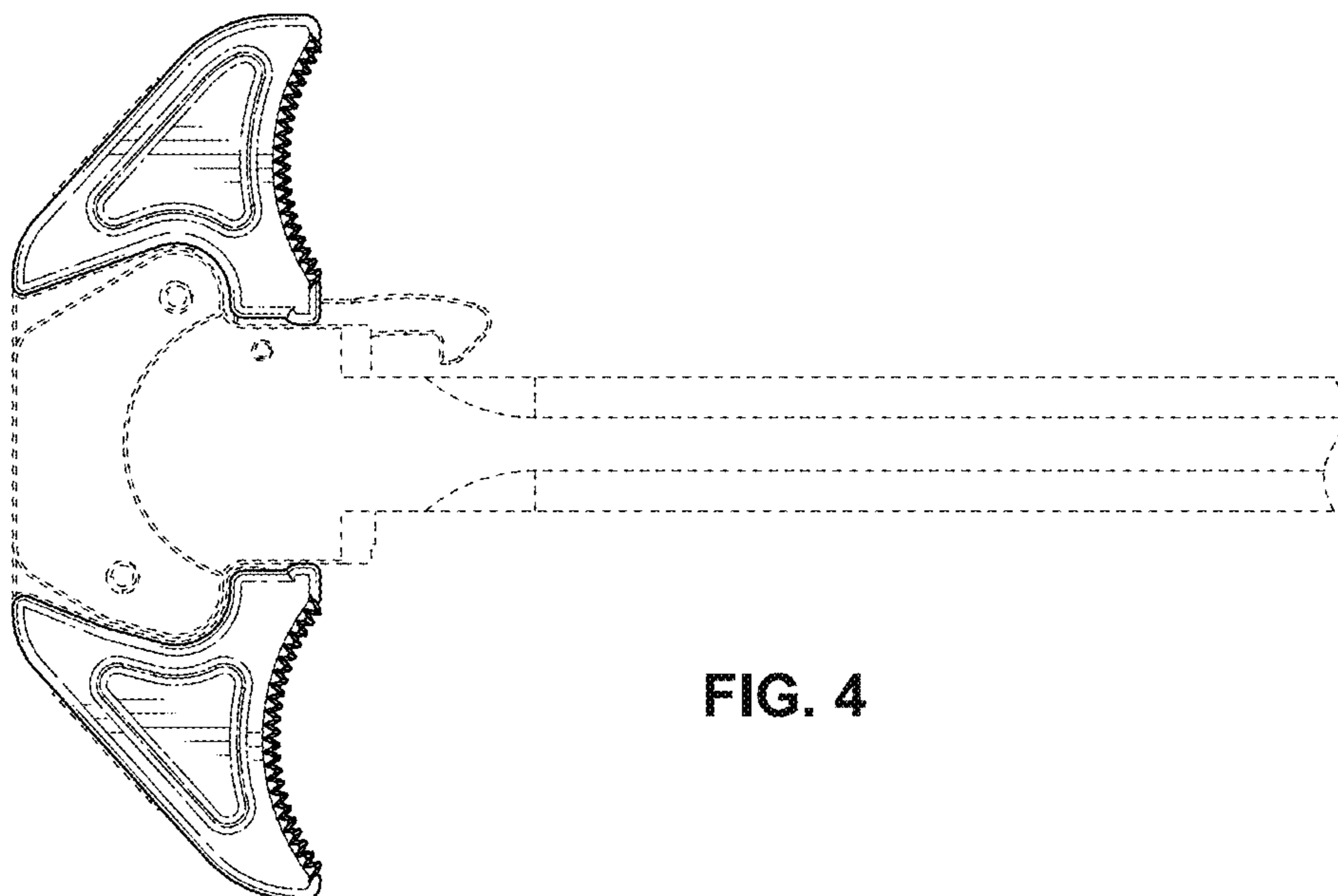

FIG. 4

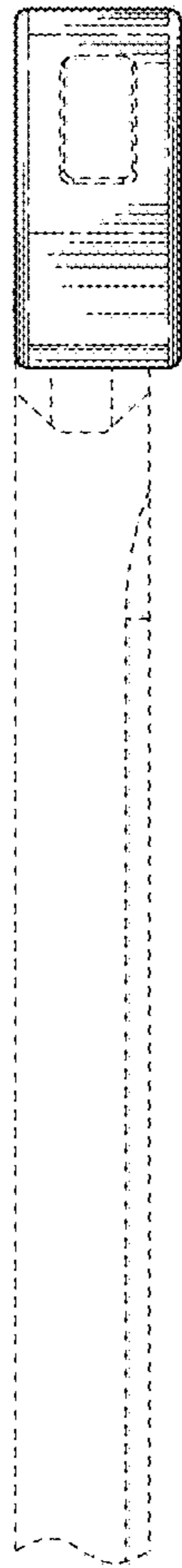

FIG. 5

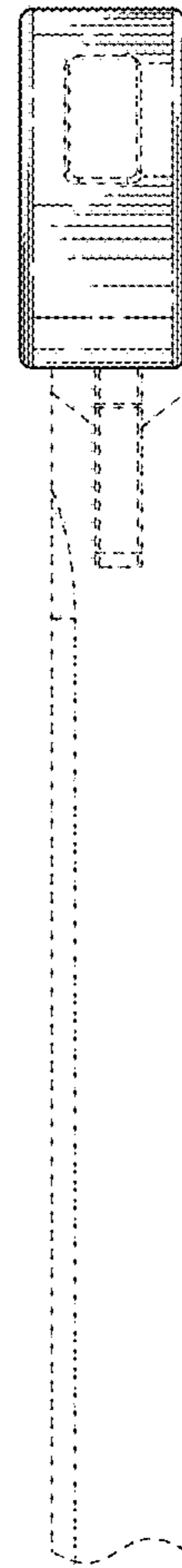

FIG. 6

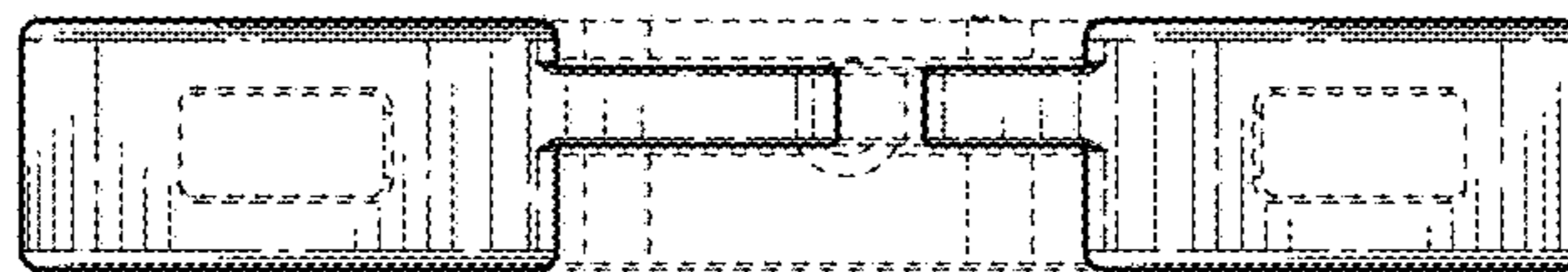

FIG. 7

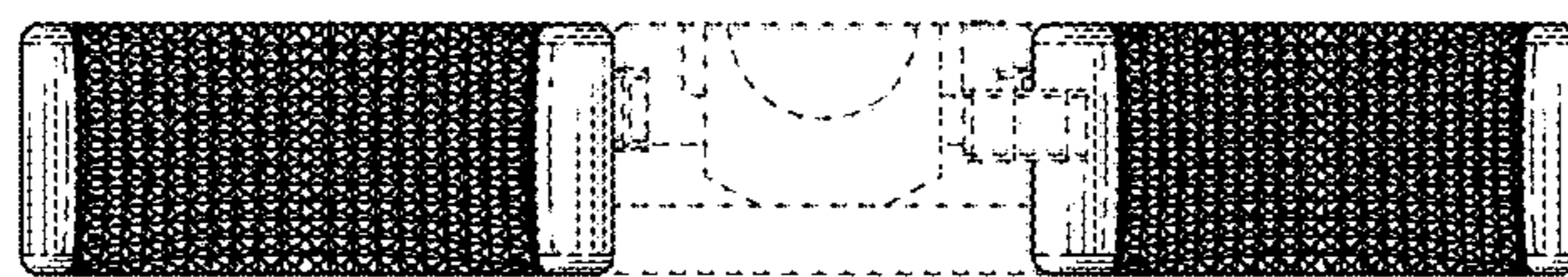

FIG. 8