

US00D794497S

(12) **United States Design Patent** (10) **Patent No.:** **US D794,497 S**  
**Galli** (45) **Date of Patent:** **\*\* Aug. 15, 2017**

(54) **RING**

(71) Applicant: **HARRY WINSTON SA,**  
Plan-les-Ouates (CH)

(72) Inventor: **Maurice Galli,** Long Island City, NY  
(US)

(73) Assignee: **HARRY WINSTON SA,**  
Plan-les-Ouates (CH)

(\*\*) Term: **15 Years**

(21) Appl. No.: **29/539,175**

(22) Filed: **Sep. 11, 2015**

(30) **Foreign Application Priority Data**

Mar. 11, 2015 (WO) ..... DM/085 817

(51) **LOC (10) Cl.** ..... **11-01**

(52) **U.S. Cl.**  
USPC ..... **D11/34**

(58) **Field of Classification Search**  
USPC ..... D11/1-5, 26-39, 91-92; 63/15,  
63/15.1-15.7, 26-28, 32  
CPC .. A44C 5/00; A44C 9/00; A44C 17/02; A44C  
9/02

See application file for complete search history.

(56) **References Cited**

U.S. PATENT DOCUMENTS

5,758,517 A *	6/1998	Freilich .....	A44C 17/02 29/10
D432,938 S *	10/2000	Vardakis .....	D11/26
D604,657 S *	11/2009	Marks .....	D11/34
D614,071 S *	4/2010	Vagal .....	D11/35
D614,072 S *	4/2010	Vagal .....	D11/35

\* cited by examiner

*Primary Examiner* — Ralf Seifert

(74) *Attorney, Agent, or Firm* — Donald J. Ranft; Collen  
IP

(57) **CLAIM**

The ornamental design for a ring, as shown.

**DESCRIPTION**

FIG. 1 is a top left perspective view of a ring showing my new design;  
 FIG. 2 is a bottom right perspective view thereof;  
 FIG. 3 is a front view thereof;  
 FIG. 4 is a rear view thereof;  
 FIG. 5 is a left side view thereof;  
 FIG. 6 is a right side view thereof;  
 FIG. 7 is a top view thereof; and,  
 FIG. 8 is a bottom view thereof.

**1 Claim, 6 Drawing Sheets**

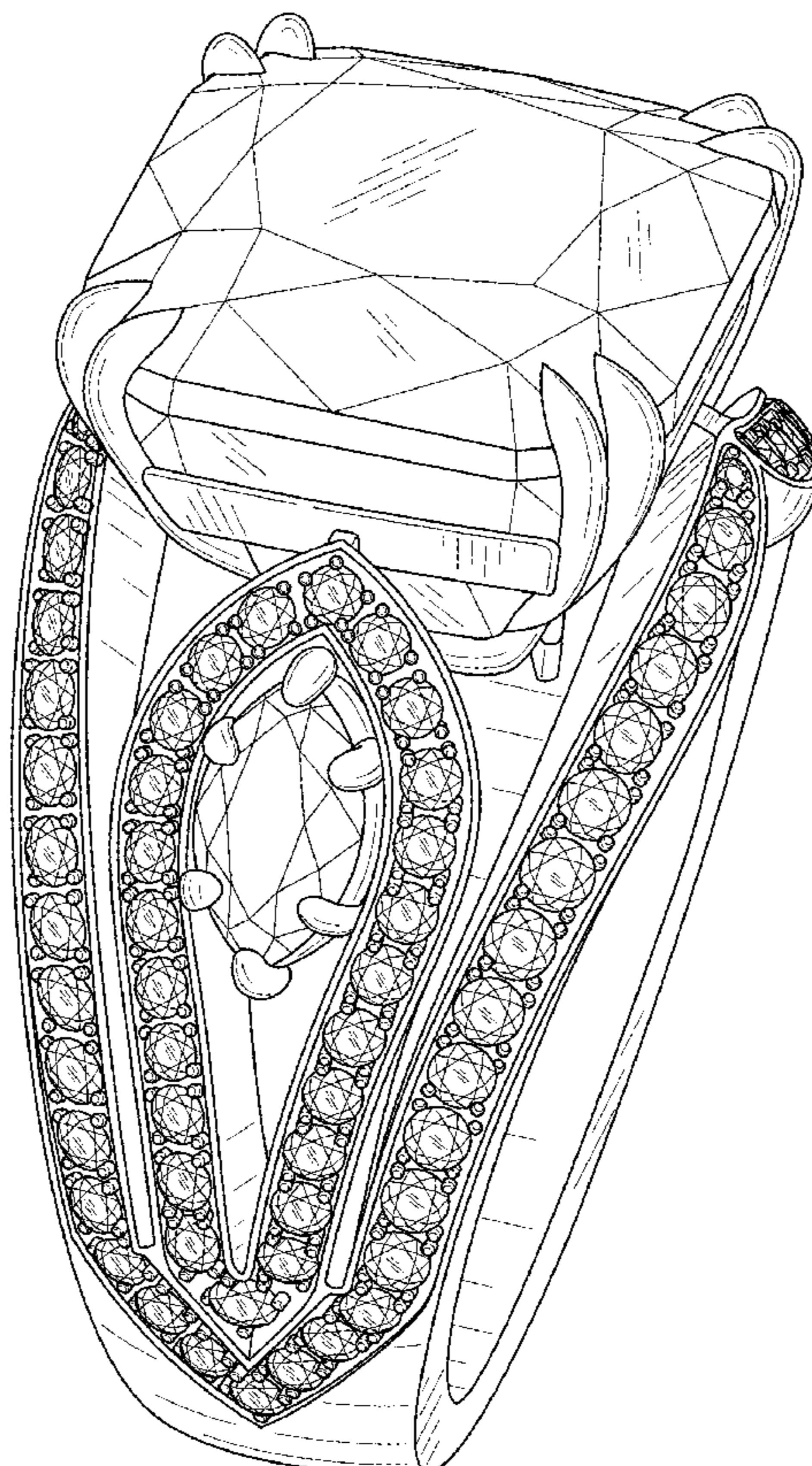

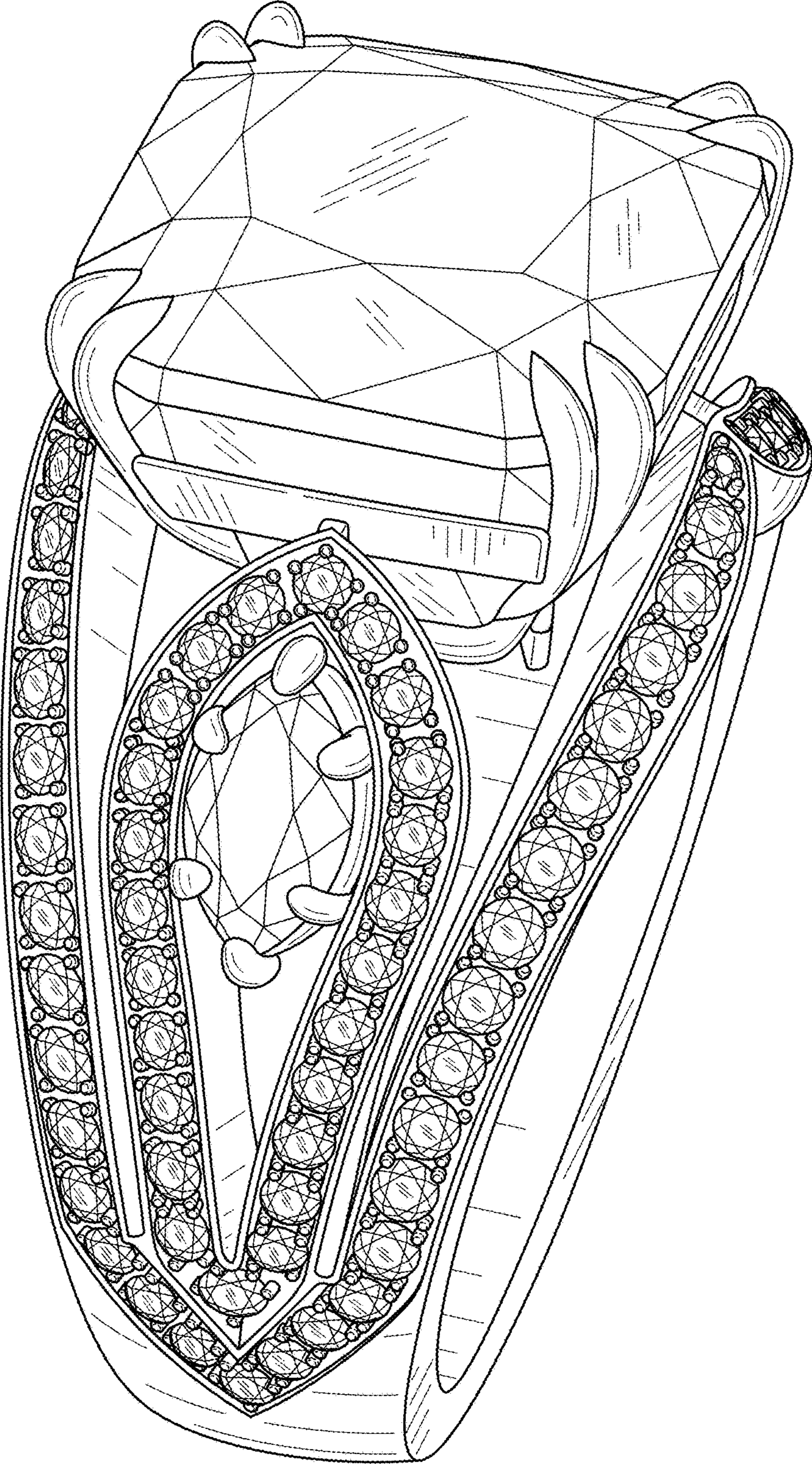

FIG. 1

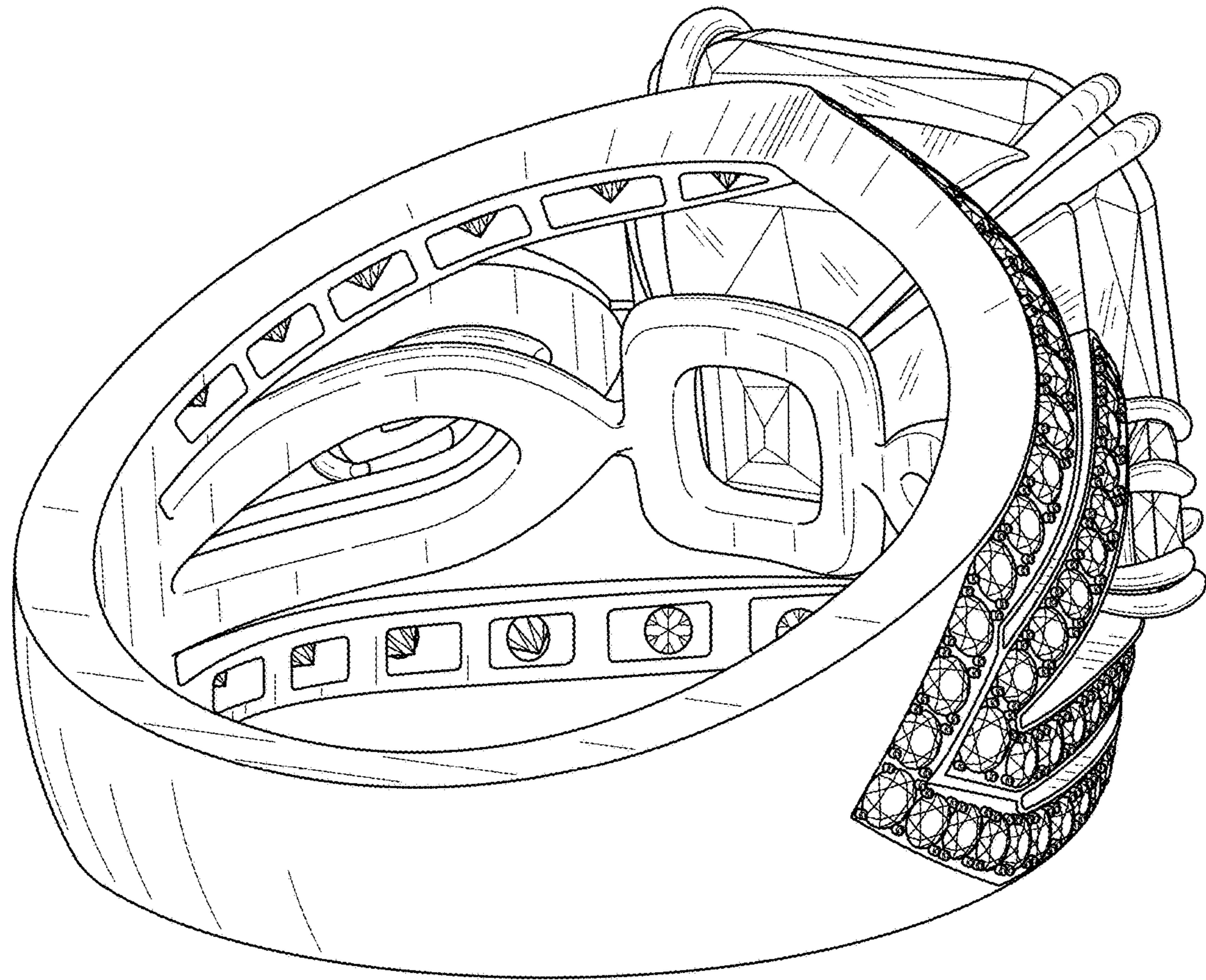

FIG. 2

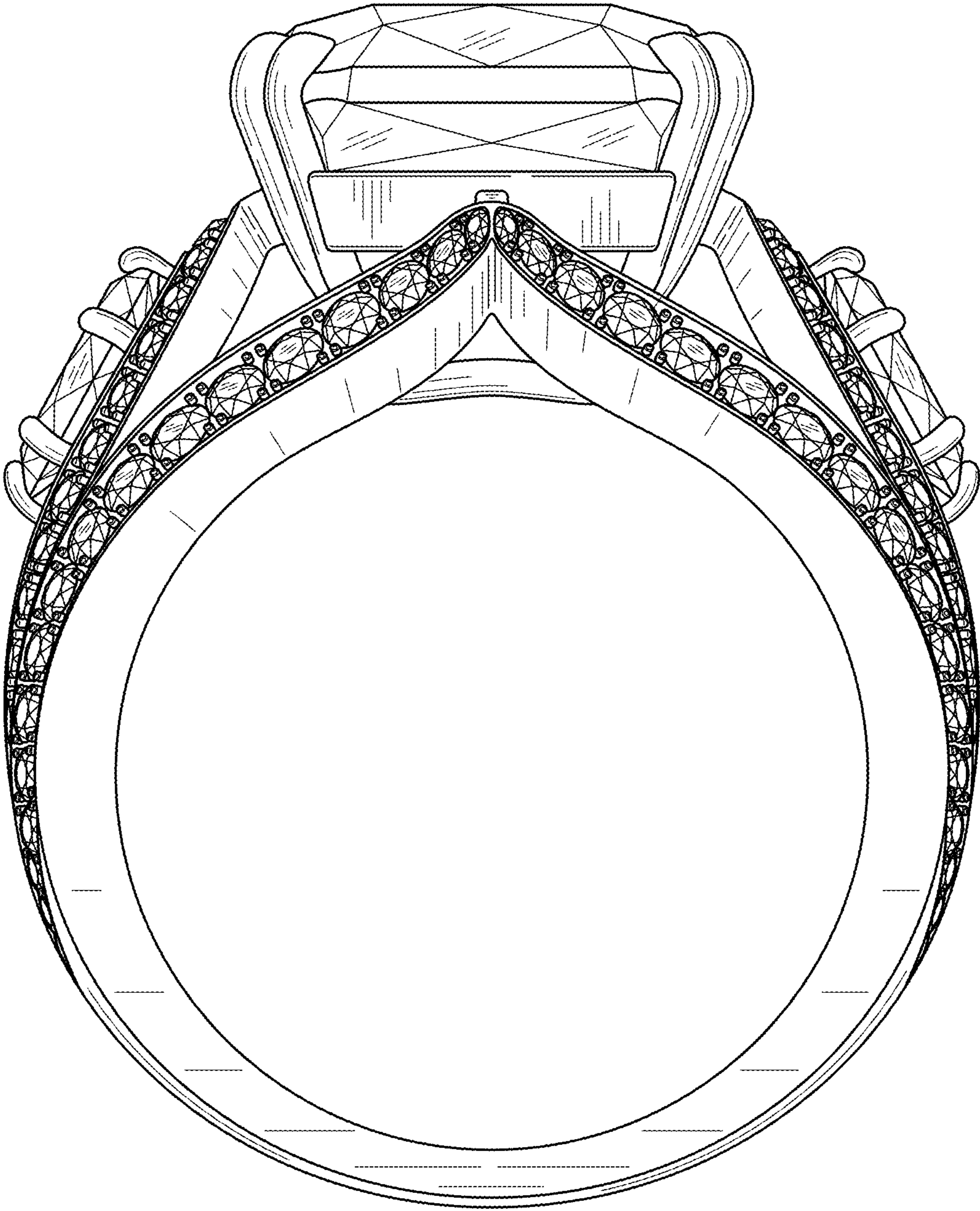

FIG. 3

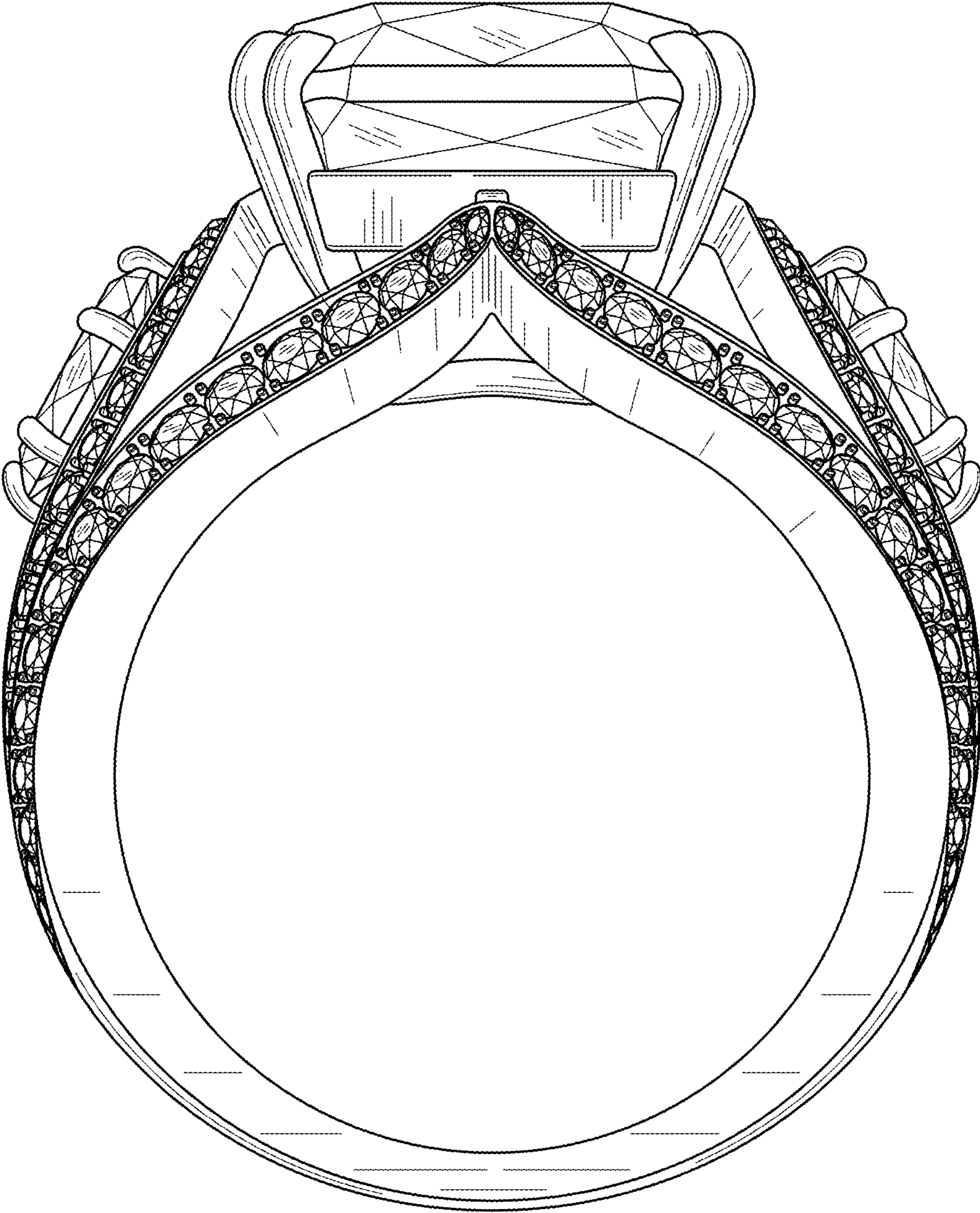

FIG. 4

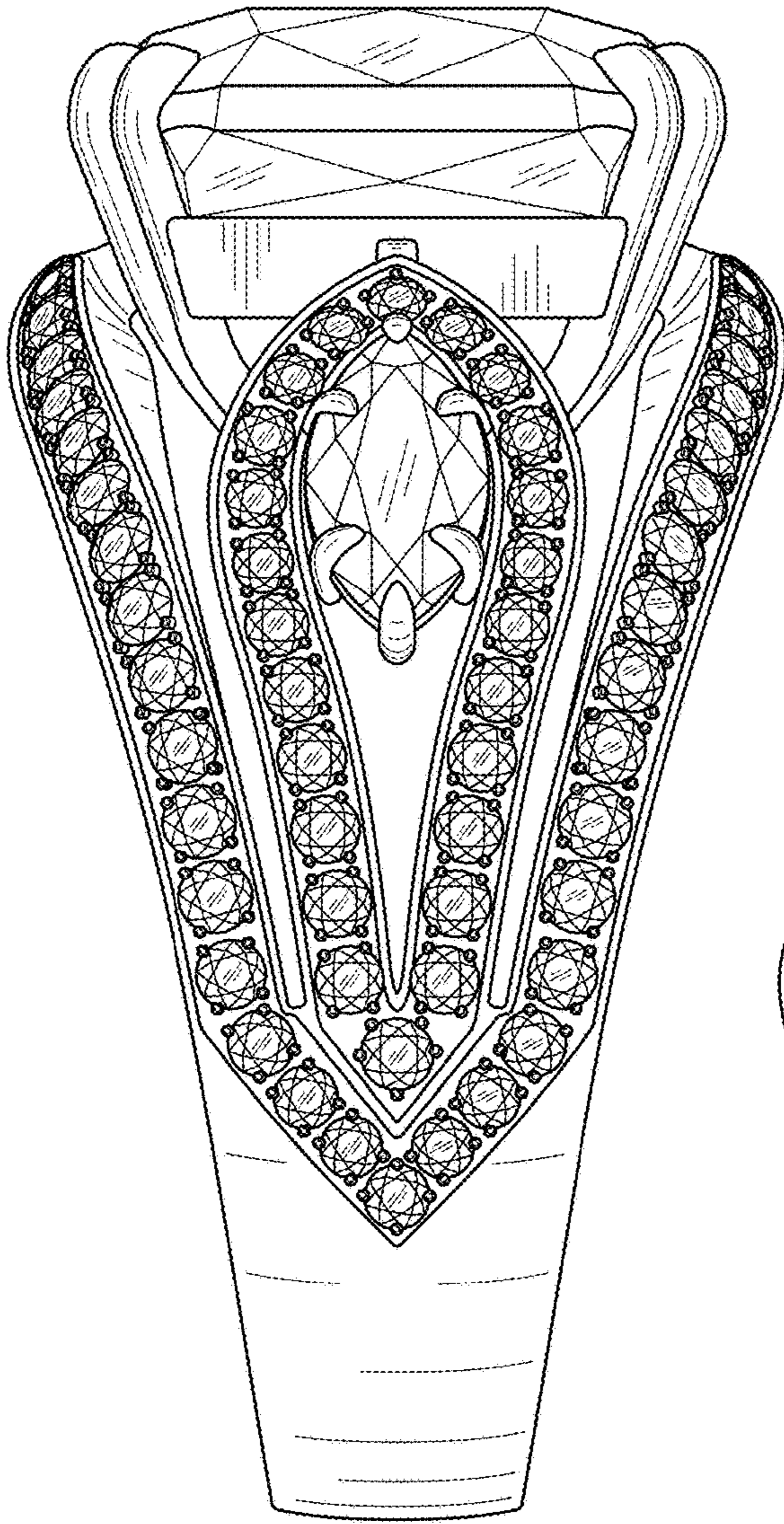

FIG. 5

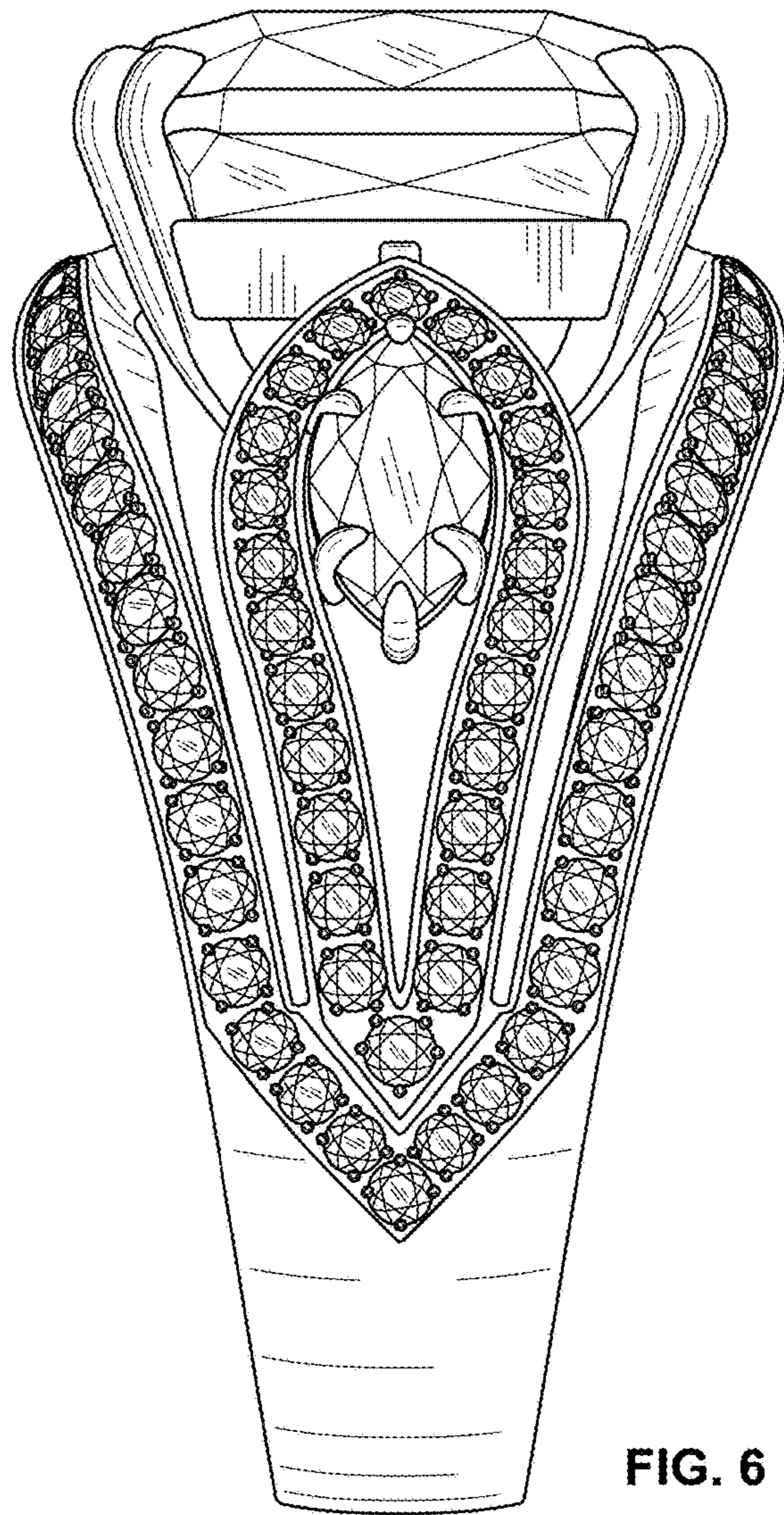

FIG. 6

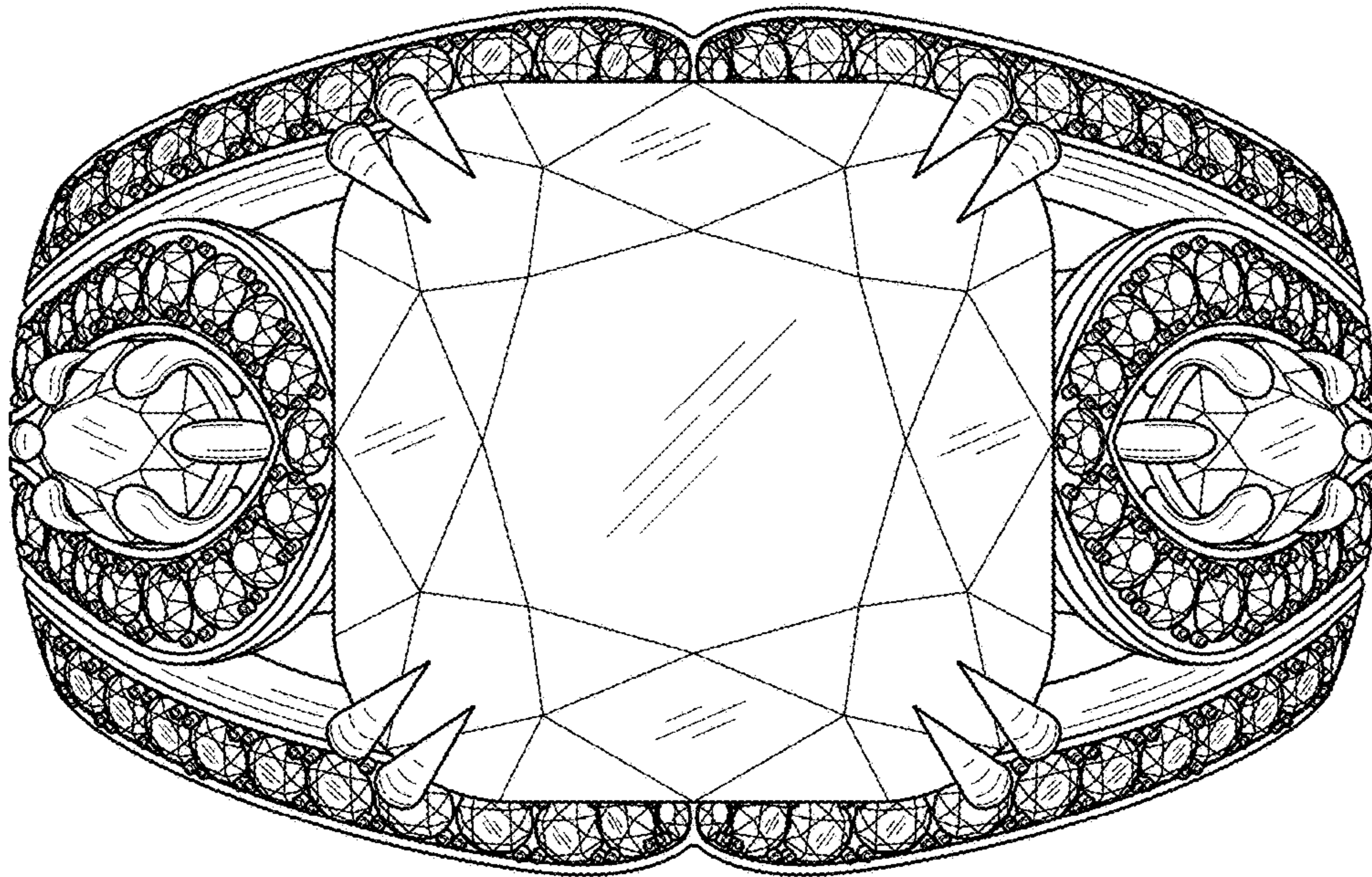

FIG. 7

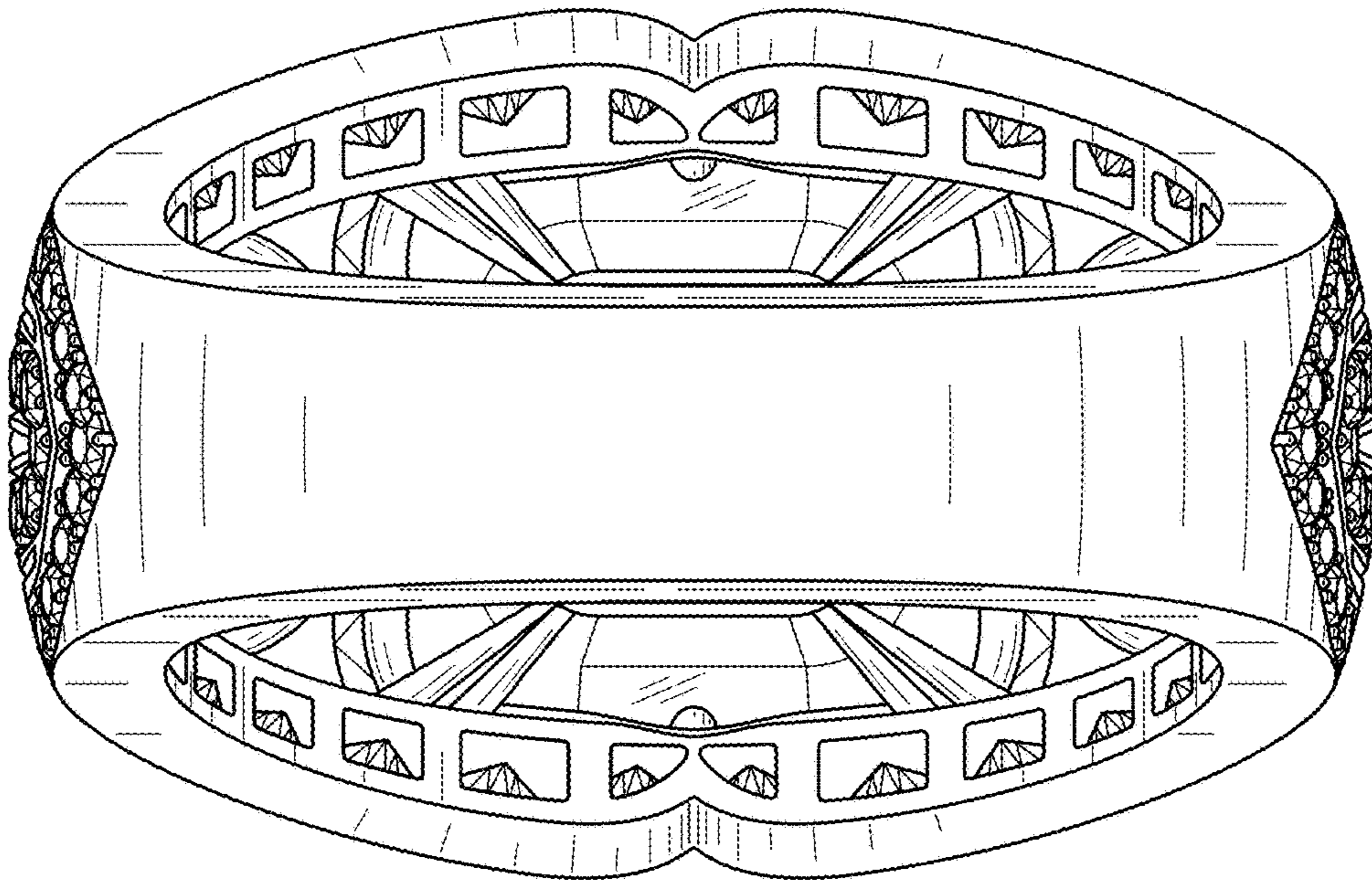

FIG. 8