



US00D794379S

(12) **United States Design Patent**
Mejia

(10) **Patent No.:** **US D794,379 S**

(45) **Date of Patent:** **** Aug. 15, 2017**

- (54) **PAN**
- (71) Applicant: **Manuel Mejia**, Medellin (CO)
- (72) Inventor: **Manuel Mejia**, Medellin (CO)
- (**) Term: **15 Years**
- (21) Appl. No.: **29/505,638**
- (22) Filed: **Dec. 24, 2015**
- (51) **LOC (10) Cl.** **07-02**
- (52) **U.S. Cl.**
USPC **D7/360; D7/354; D7/361**
- (58) **Field of Classification Search**
USPC D7/323, 354-363, 387, 391, 393-396,
D7/409
CPC A47G 19/12; A47J 27/00; A47J 27/002;
A47J 27/08; A47J 27/21; A47J 27/58;
A47J 36/025; A47J 36/02; A47J 36/06;
A47J 36/08; A47J 36/12; A47J 37/00;
A47J 37/10; A47J 37/101; A47J 37/103;
A47J 37/12; A47J 37/1204; A47J 45/061;
A47J 45/071; A47J 45/08; H05B 6/12
See application file for complete search history.

- (56) **References Cited**
U.S. PATENT DOCUMENTS
D85,804 S * 12/1931 Axford D7/359
1,970,723 A * 8/1934 Wolfe A47J 36/02
110/101 A

- 2,788,561 A * 4/1957 Mueller F27D 5/00
215/375
- D258,189 S * 2/1981 Miller D7/360
- D414,981 S * 10/1999 Roskind D7/359
- 6,419,107 B1 * 7/2002 Cheng A47J 36/08
220/366.1
- D572,077 S * 7/2008 Duke D7/387
- D586,177 S * 2/2009 Loring D7/361
- D618,494 S * 6/2010 Welk D7/354
- D628,851 S * 12/2010 Bergne D7/354
- D656,358 S * 3/2012 Cloutier D7/354
- D672,604 S * 12/2012 Upston D7/354
- D756,163 S * 5/2016 Gabbay D7/354

* cited by examiner

Primary Examiner — Ricky Pham
(74) *Attorney, Agent, or Firm* — Sanchelima &
Associates, P.A.; Jesus Sanchelima; Christian Sanchelima

(57) **CLAIM**

The ornamental design for a pan, as shown and described.

DESCRIPTION

FIG. 1 is an isometric view of a pan showing my new design;
FIG. 2 is a side elevational view thereof;
FIG. 3 is a bottom inclined view thereof;
FIG. 4 is a top view thereof;
FIG. 5 is a front elevational view thereof; and,
FIG. 6 is a bottom view thereof.

1 Claim, 6 Drawing Sheets

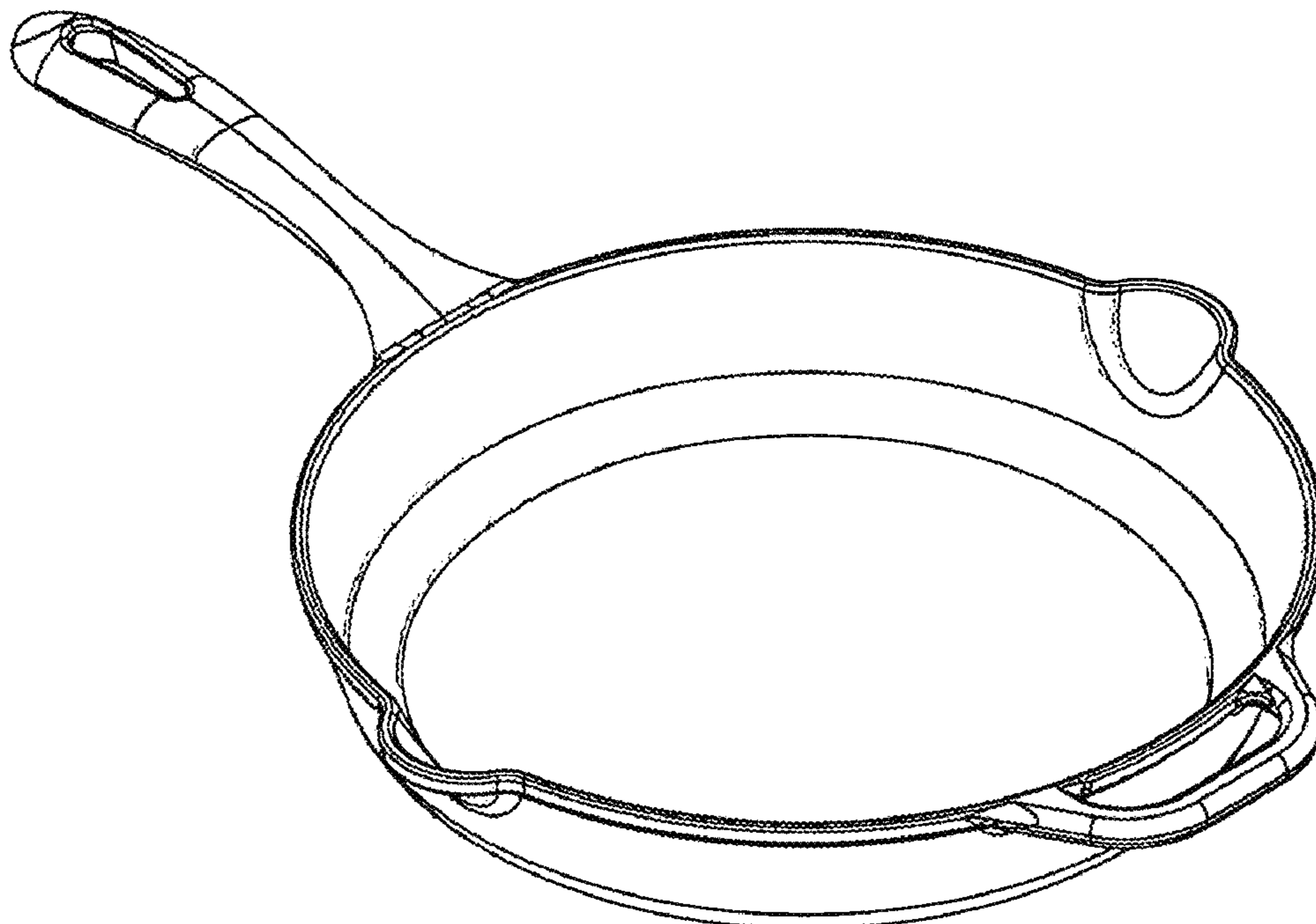

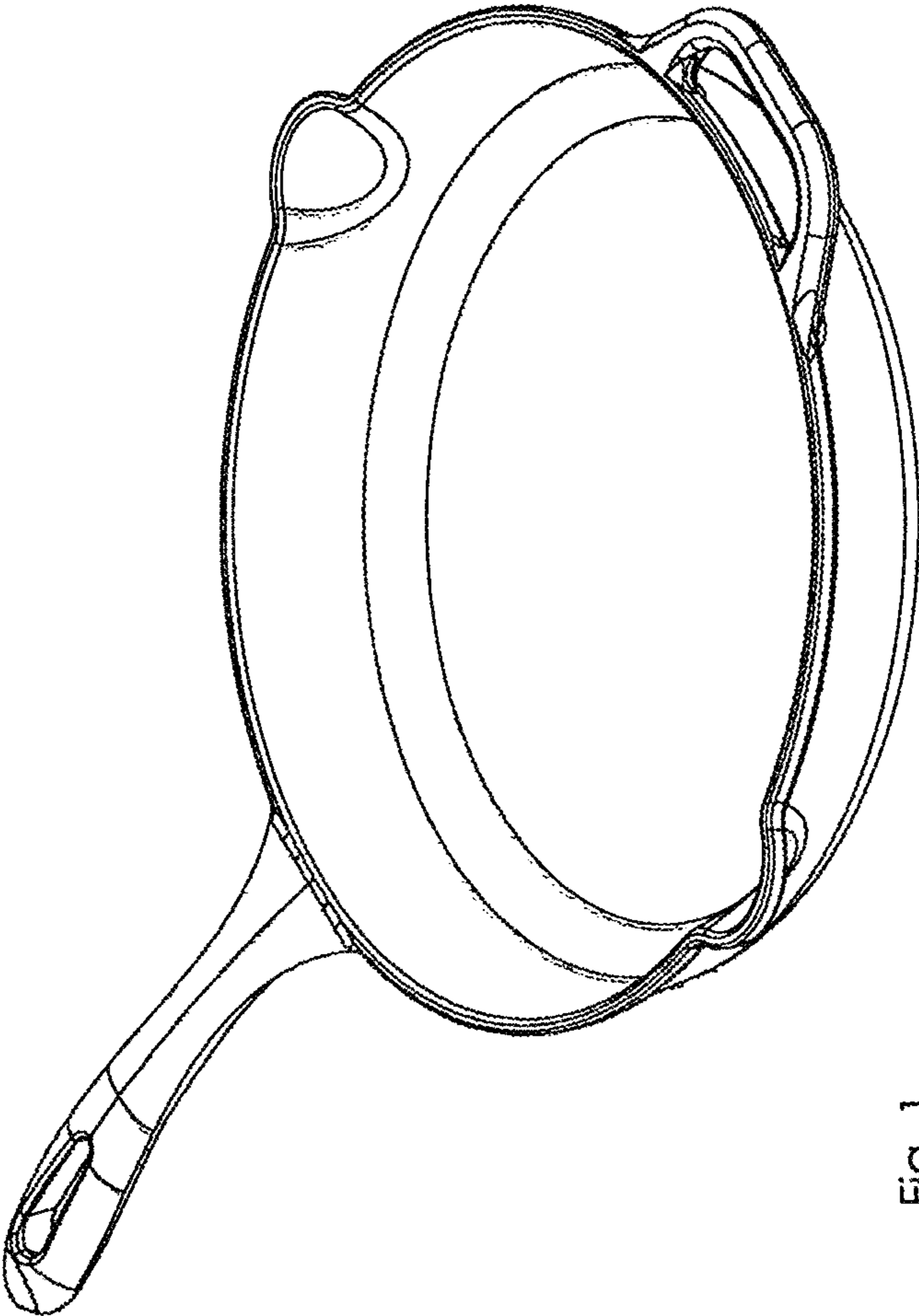

Fig. 1

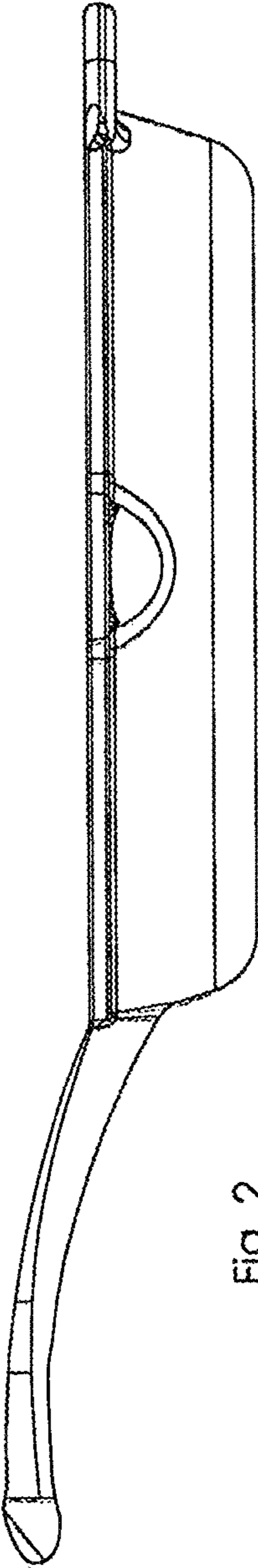

Fig. 2

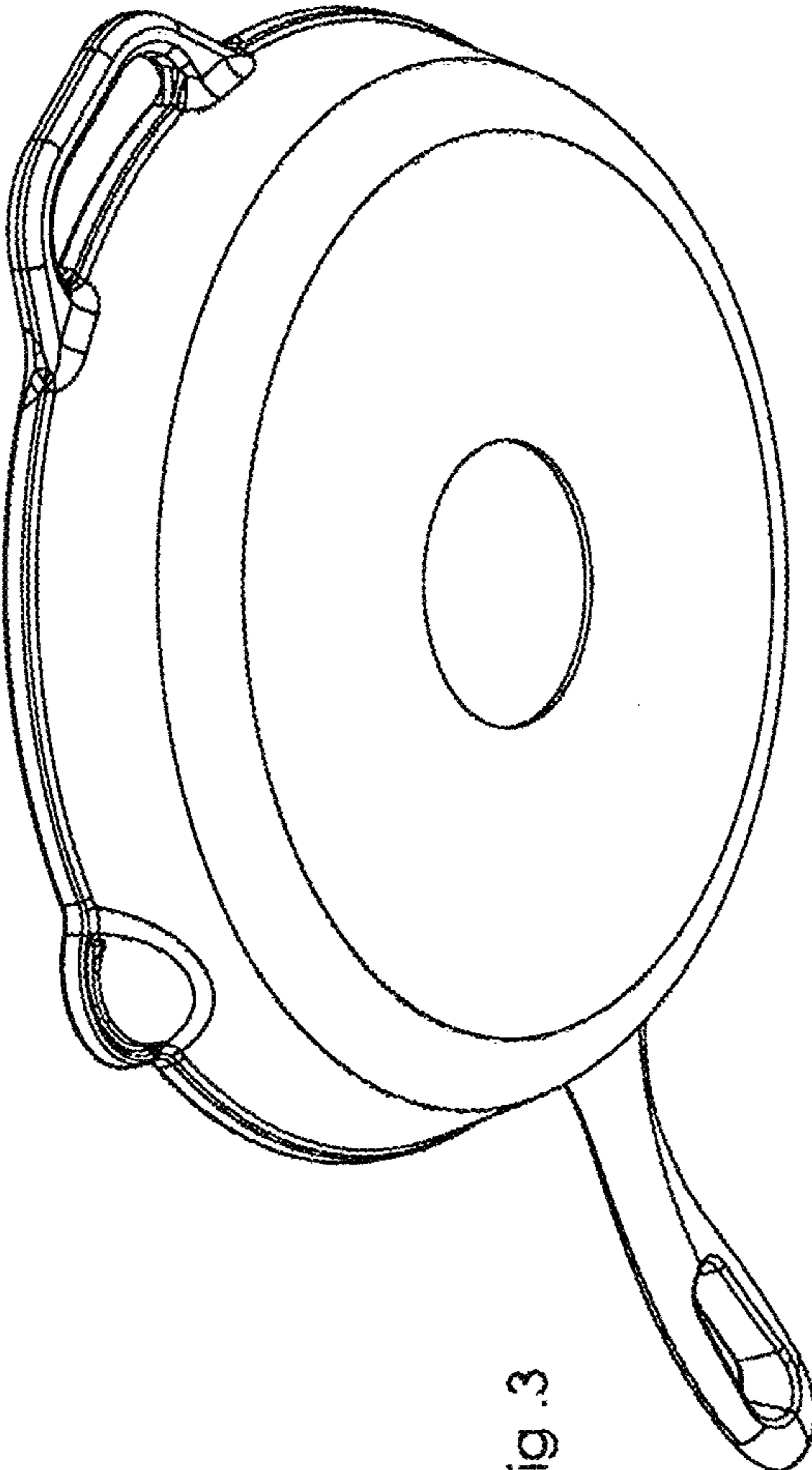

Fig. 3

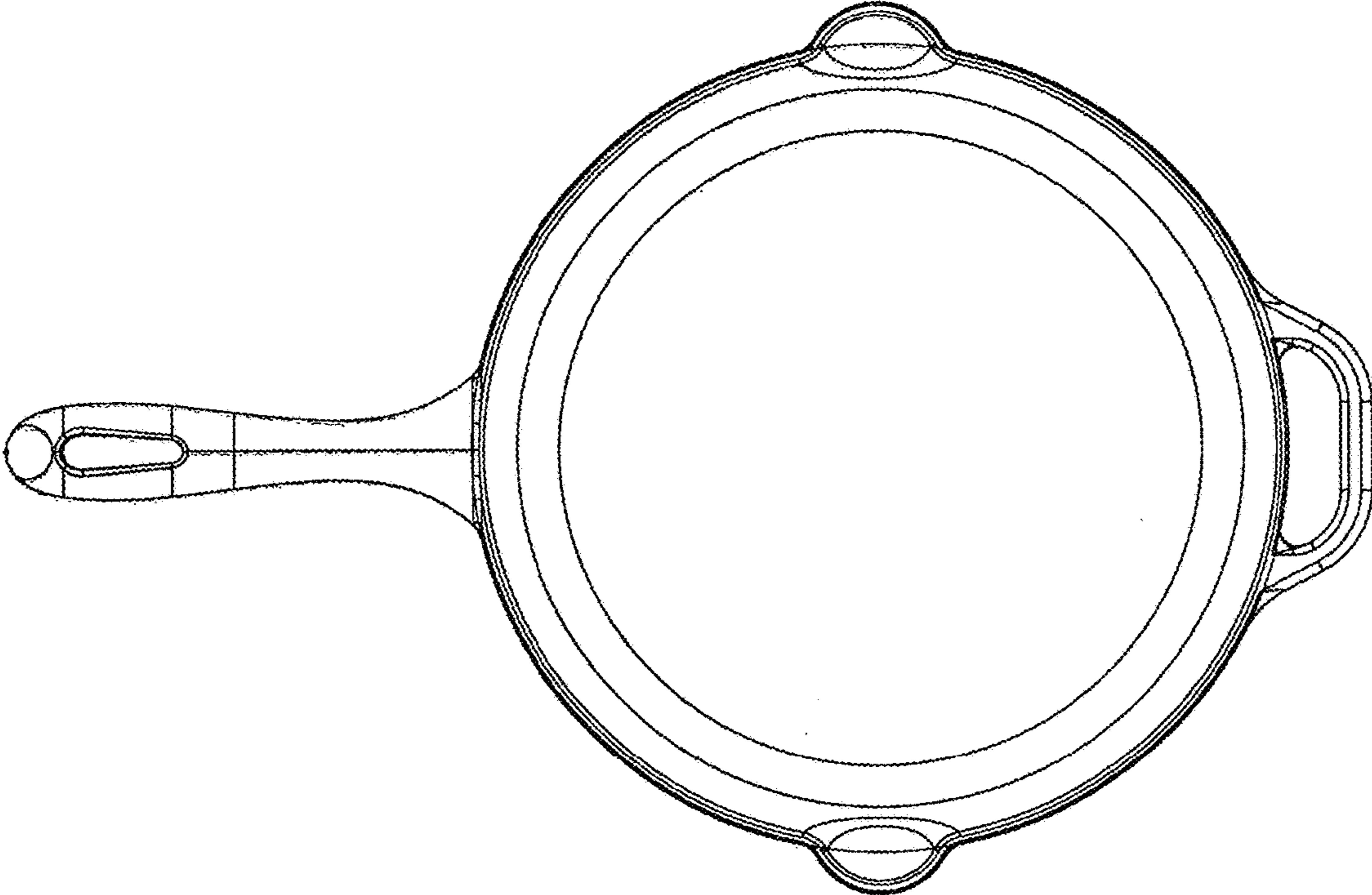

Fig. 4

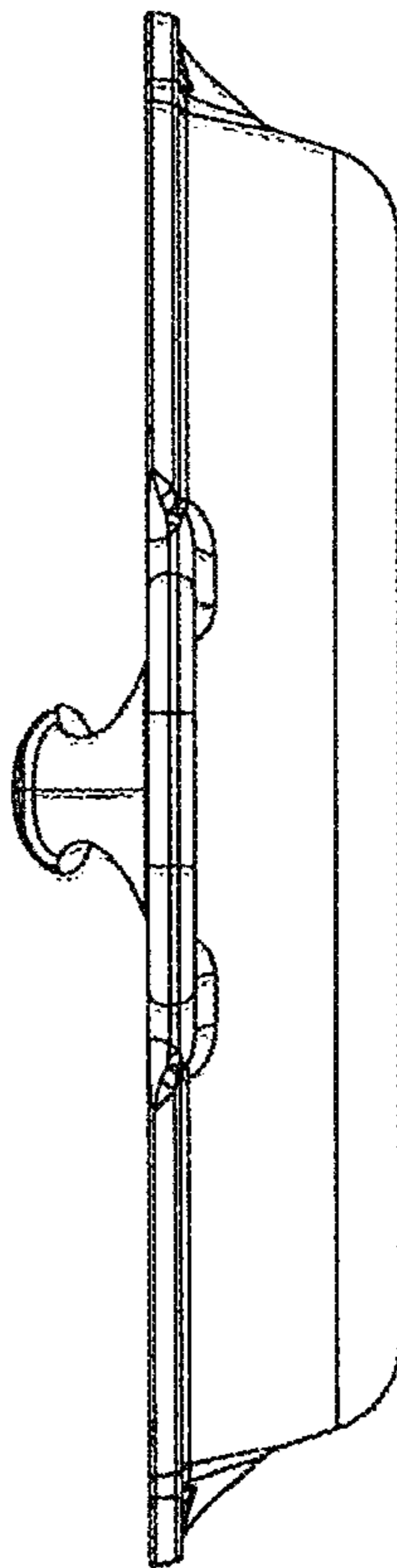

Fig. 5

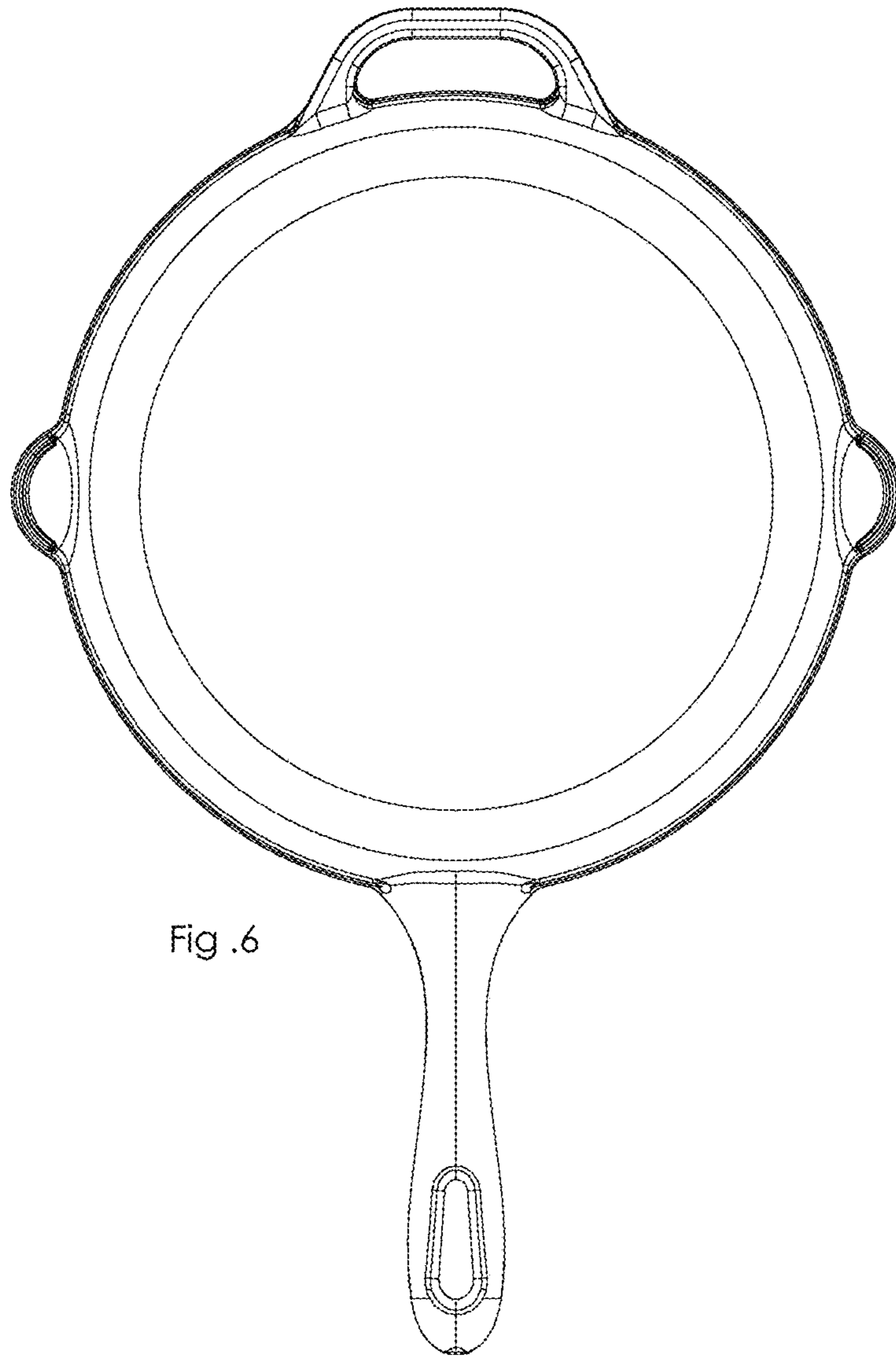

Fig. 6