



US00D794185S

(12) **United States Design Patent**
Dolk et al.

(10) **Patent No.:** **US D794,185 S**

(45) **Date of Patent:** **** Aug. 8, 2017**

(54) **SYRINGE PART**
(71) Applicant: **Q-MED AB**, Uppsala (SE)
(72) Inventors: **Jonas Dolk**, Uppsala (SE); **Hans Himbert**, Uppsala (SE); **Pelle Reinius**, Uppsala (SE)
(73) Assignee: **Q-MED AB**, Uppsala (SE)

(**) Term: **14 Years**

(21) Appl. No.: **29/475,140**

(22) Filed: **Nov. 29, 2013**

(30) **Foreign Application Priority Data**

Jun. 17, 2013 (EM) 002256255

(51) **LOC (10) Cl.** **24-01**

(52) **U.S. Cl.**
USPC **D24/130**

(58) **Field of Classification Search**
USPC D24/112–114, 133, 186, 104, 130, 127;
606/181, 185; 604/264, 272, 115, 232,
604/187, 158, 164.08, 192, 263, 163, 181,
604/184, 198, 227
CPC A61M 5/31596; A61M 2005/1787; A61M
2005/31508; A61M 5/31511; A61M
2005/3121; A61M 2005/31598; A61M
2005/3123

See application file for complete search history.

(56) **References Cited**

U.S. PATENT DOCUMENTS

D287,877 S * 1/1987 Holewinski D24/114
D397,790 S * 9/1998 Naganuma D24/127
D401,324 S * 11/1998 Hjertman D24/114
D425,198 S * 5/2000 Porta D24/114
D436,661 S * 1/2001 Berry D24/114

6,425,885 B1 * 7/2002 Fischer A61M 5/48
604/187
6,530,906 B2 * 3/2003 Hu A61M 5/322
128/919
D543,278 S * 5/2007 Numata D24/114
D574,954 S * 8/2008 Smith D24/114
D581,044 S * 11/2008 Sudo D24/130
D581,527 S * 11/2008 Jansen D24/130
D618,347 S * 6/2010 Bradshaw D24/108
D627,877 S * 11/2010 Schmelling D24/114
D651,309 S * 12/2011 Rowe D24/130
D657,867 S * 4/2012 Effenberger D24/114
D668,760 S * 10/2012 Kawamura D24/130
8,337,468 B1 * 12/2012 Reis A61M 5/3257
604/181
D674,086 S * 1/2013 Khalaj D24/114
D689,188 S * 9/2013 Lundquist D24/130
D698,918 S * 2/2014 Leiner D24/114
D717,429 S * 11/2014 Kawamura D24/130
D721,803 S * 1/2015 Dubach D24/114

(Continued)

Primary Examiner — David Muller

Assistant Examiner — Nathan Johnston

(74) *Attorney, Agent, or Firm* — Birch, Stewart, Kolasch & Birch, LLP

(57) **CLAIM**

The ornamental design for a syringe part, as shown and described.

DESCRIPTION

FIG. 1 is a top, front, right perspective view of a syringe part showing our new design;
FIG. 2 is a front elevation view thereof;
FIG. 3 is a rear elevation view thereof;
FIG. 4 is a right side elevation view thereof;
FIG. 5 is a left side elevation view thereof;
FIG. 6 is a top plan view thereof; and,
FIG. 7 is a bottom plan view thereof.
The features shown in broken lines form no part of the claimed design.

1 Claim, 7 Drawing Sheets

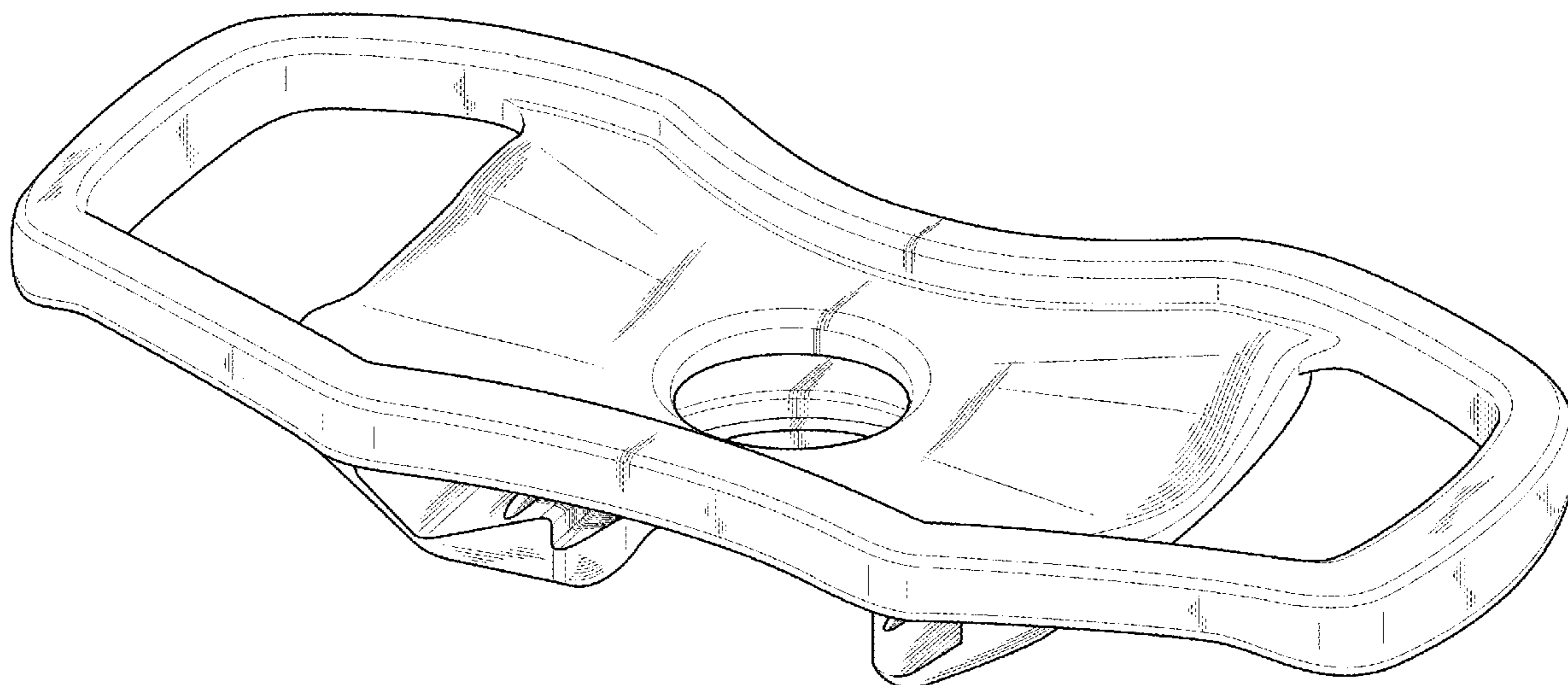

(56)

References Cited

U.S. PATENT DOCUMENTS

2006/0084917 A1* 4/2006 Chen A61M 5/322
604/110
2013/0116628 A1* 5/2013 Kulshrestha A61M 5/31511
604/227
2015/0018798 A1* 1/2015 Tornsten A61M 5/3286
604/506
2015/0073353 A1* 3/2015 Strader A61M 5/24
604/189

* cited by examiner

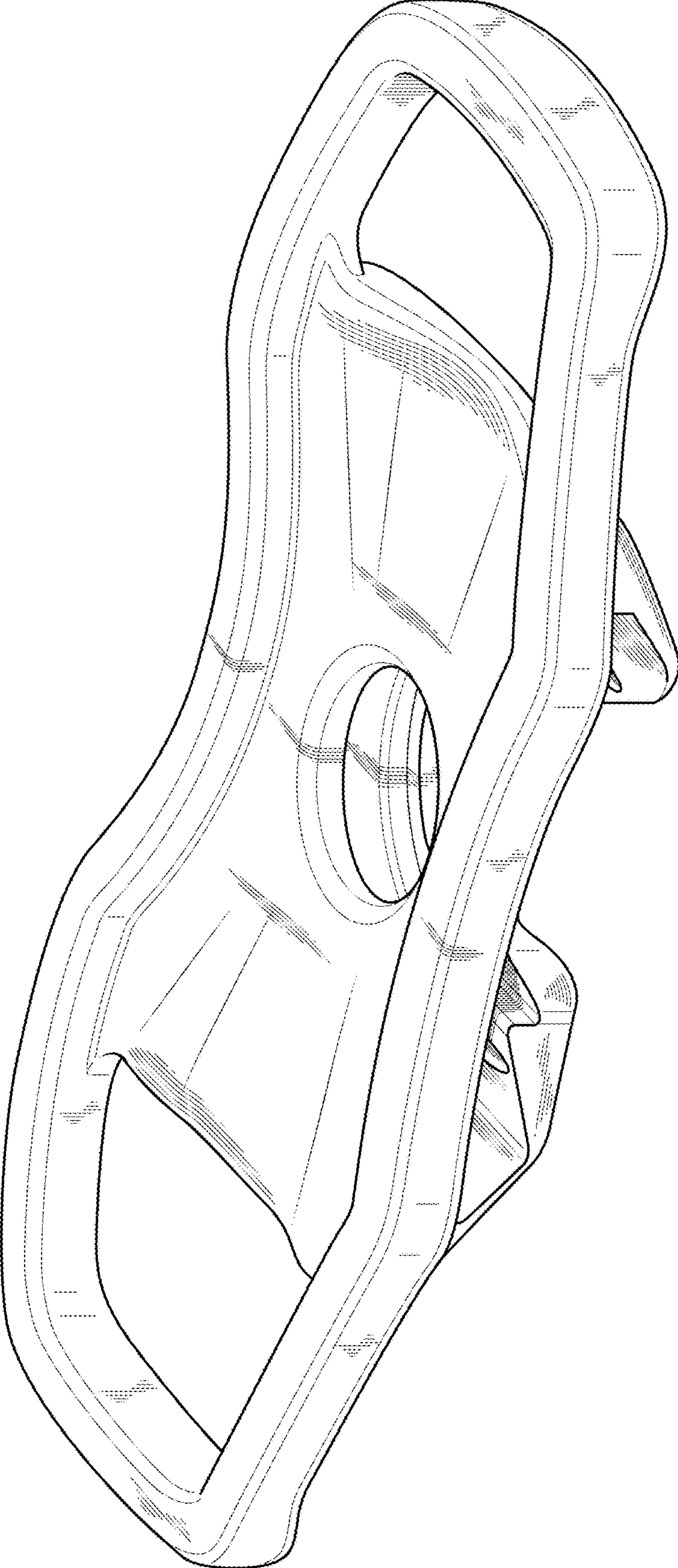

Fig. 1

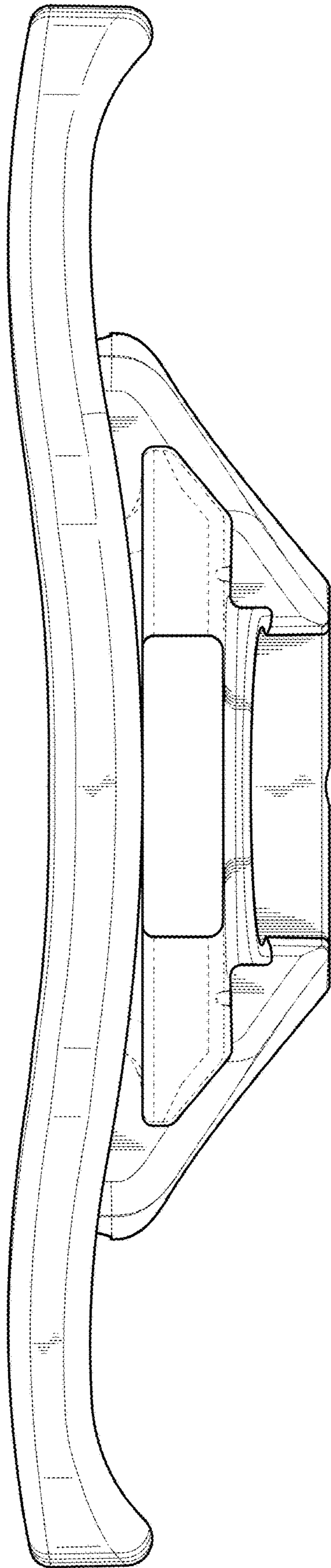

Fig. 2

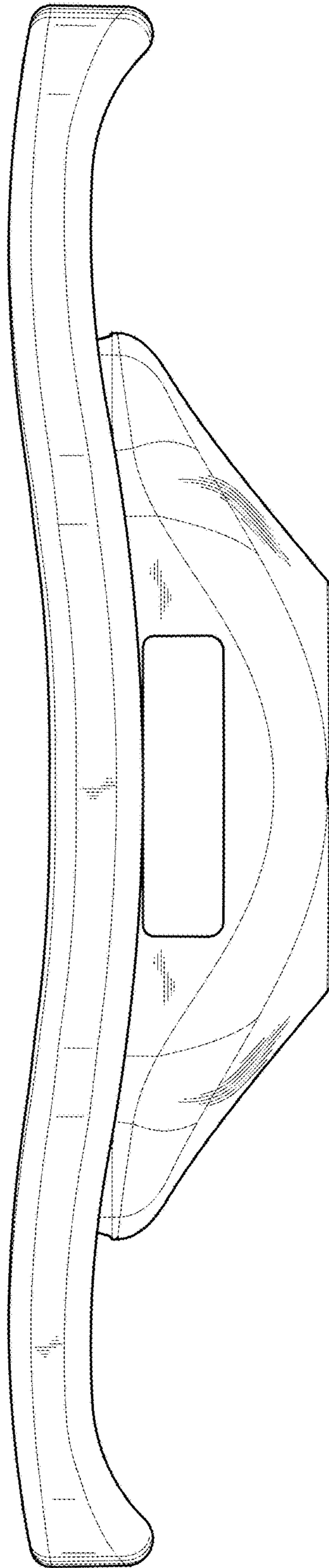

Fig. 3

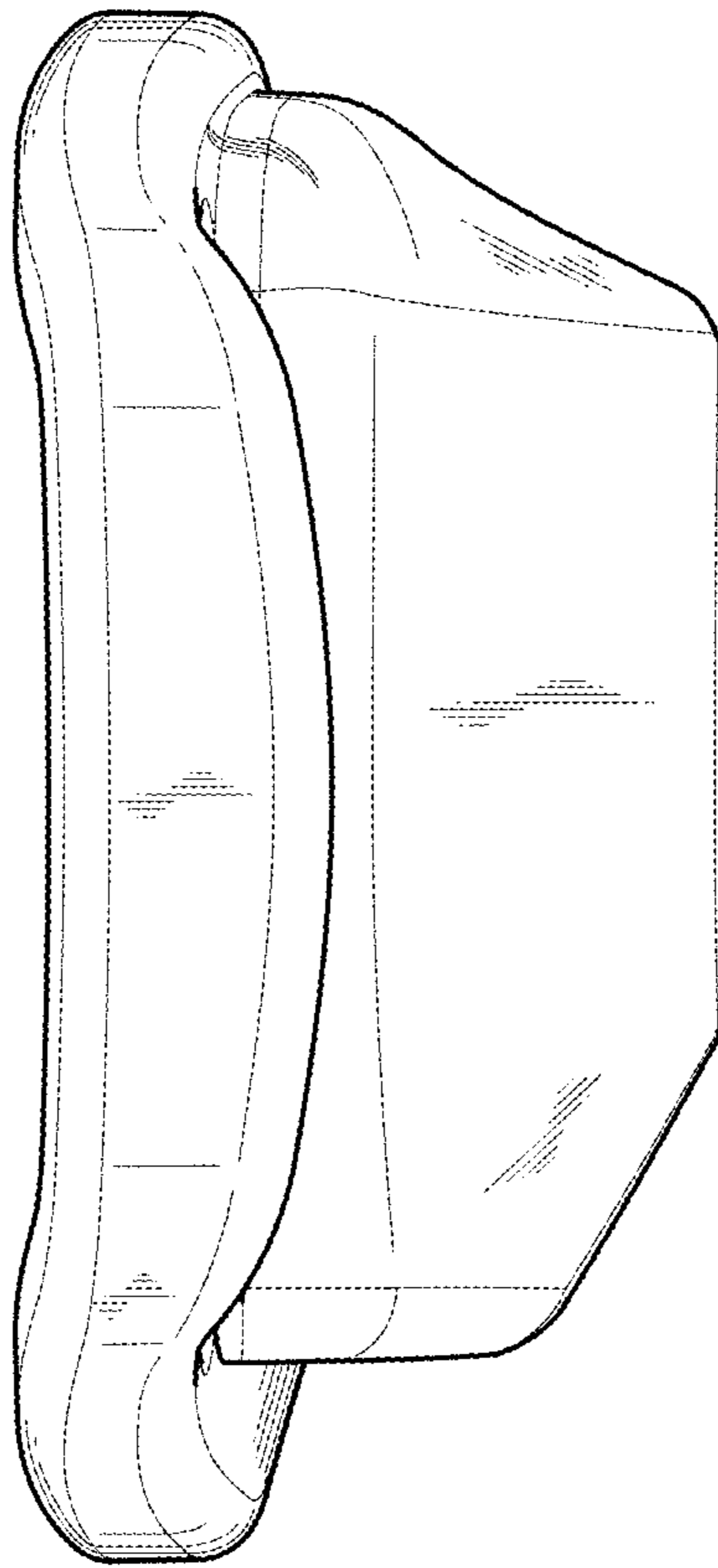

Fig. 4

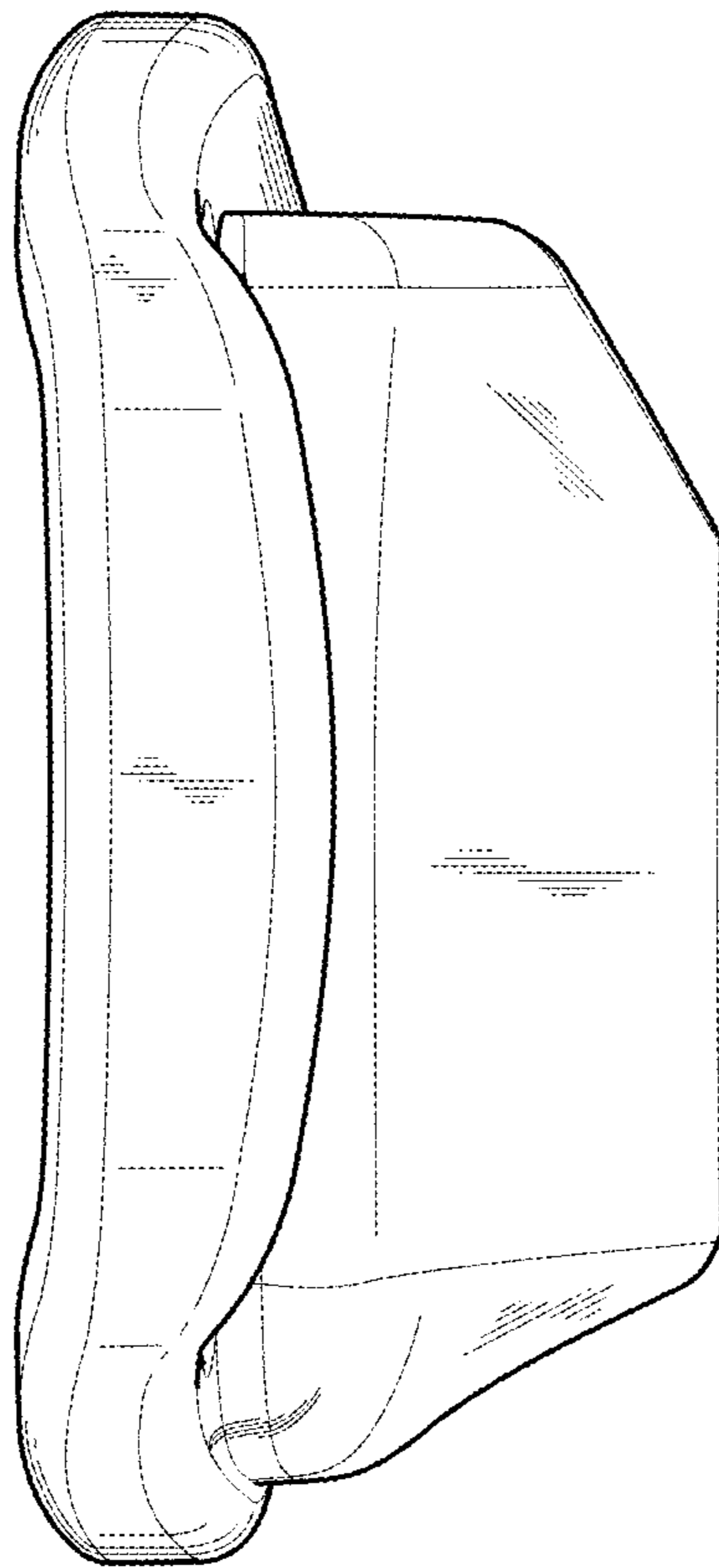

Fig. 5

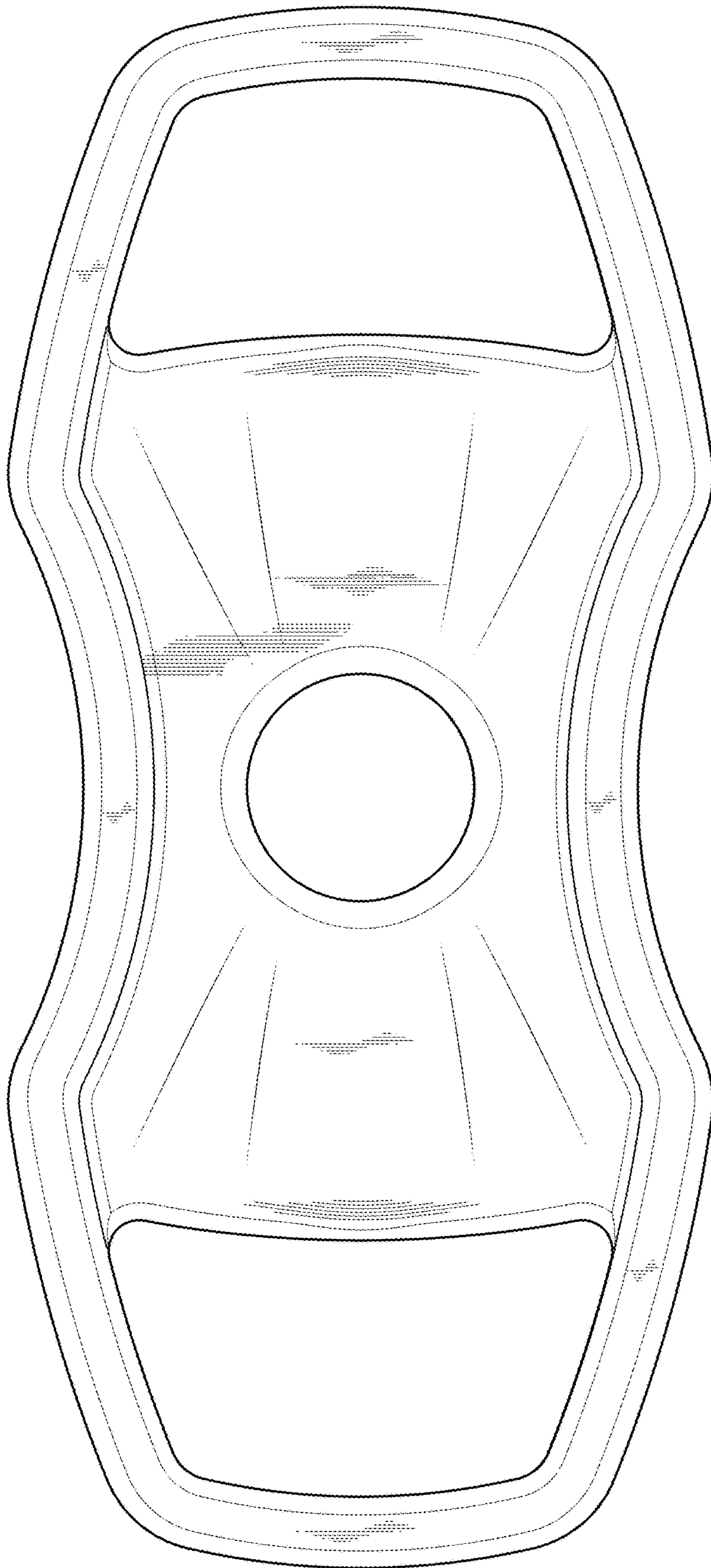

Fig. 6

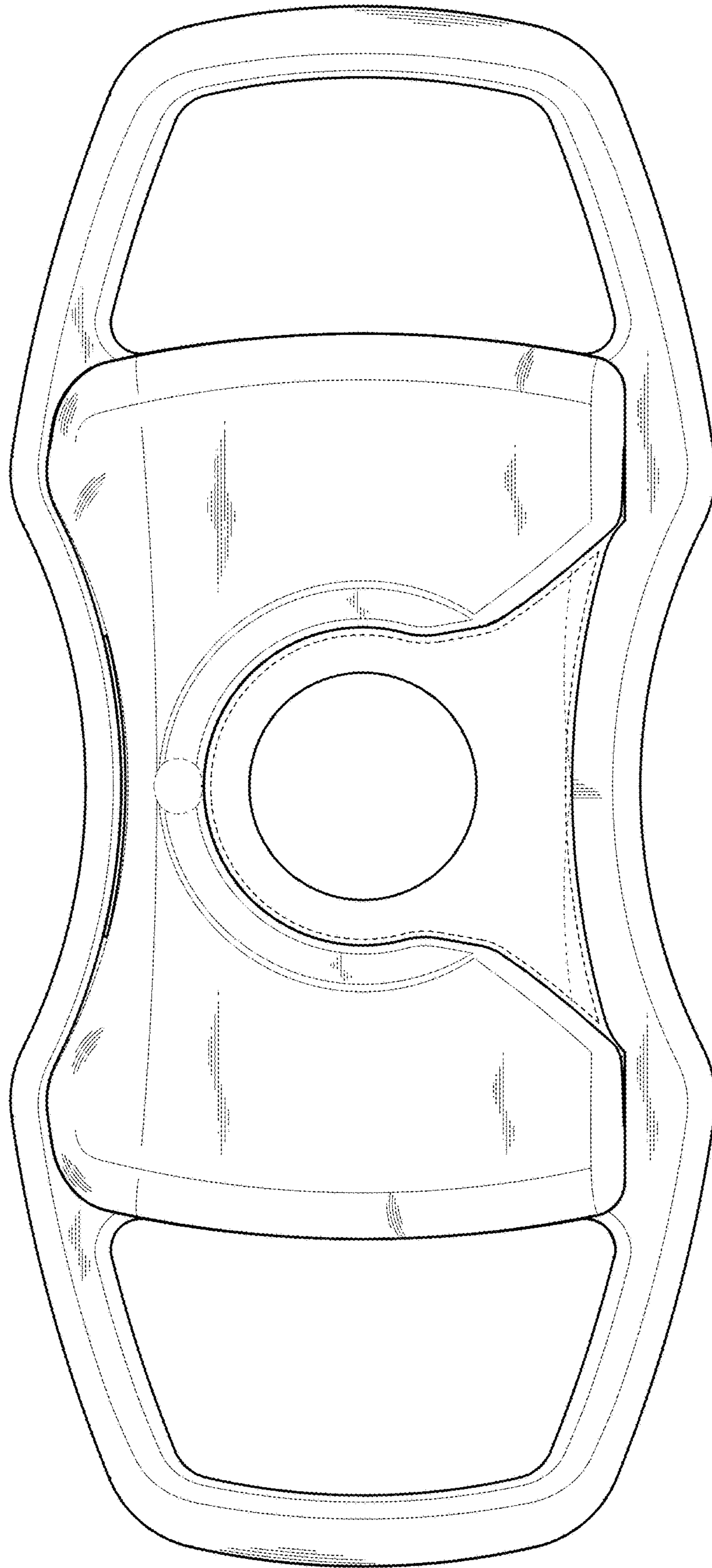

Fig. 7