



US00D794167S

(12) **United States Design Patent** (10) **Patent No.:** **US D794,167 S**
Burke (45) **Date of Patent:** **** Aug. 8, 2017**

(54) **BATH TUB** 4,535,489 A * 8/1985 Elkins A47K 3/001
4/538
(71) Applicant: **VICTORIA & ALBERT BATHS** D451,986 S * 12/2001 Marshall D23/280.1
LIMITED, Telford, Shropshire (GB) D470,579 S * 2/2003 Foster D23/280.1
D510,615 S * 10/2005 Matthews D23/280.1
(72) Inventor: **Tom Burke**, Telford (GB) D564,639 S * 3/2008 Bruce D23/280.1
D566,247 S * 4/2008 Cunningham D23/280.1
D595,392 S * 6/2009 Verlinden D23/278
(73) Assignee: **Victoria & Albert Baths Limited**, D611,127 S * 3/2010 Urquiola D23/277
Telford (GB) D614,738 S * 4/2010 Lebrun D23/277
D694,866 S * 12/2013 Quigley D23/277
(**) Term: **15 Years** D709,598 S * 7/2014 Dupras D23/280.1
D724,706 S * 3/2015 Meneghello D23/277
D745,645 S * 12/2015 Burke D23/277

(21) Appl. No.: **35/501,006**

(22) Filed: **May 9, 2016**

(80) **Hague Agreement Data**

Int. Filing Date: **May 9, 2016**
Int. Reg. No.: **DM/090592**
Int. Reg. Date: **May 9, 2016**
Int. Reg. Pub. Date: **May 27, 2016**

(51) **LOC (10) Cl.** **23-02**

(52) **U.S. Cl.**
USPC **D23/277**

(Continued)CPC **A47K 3/02 (2013.01)**

(58) **Field of Classification Search**
USPC D23/275-277, 280.1, 303-306;
4/663-665, 538
CPC A47K 4/00; A47K 3/02
See application file for complete search history.

(56) **References Cited**

U.S. PATENT DOCUMENTS

D17,902 S * 11/1887 Torrance D23/280.1
1,325,423 A * 12/1919 Stuart A47K 3/122
182/116

* cited by examiner

Primary Examiner — Richard E Chilcot

(74) *Attorney, Agent, or Firm* — Blank Rome LLP

(57) **CLAIM**

The ornamental design for a bath tub, as shown and described.

DESCRIPTION

- 1. Bath tub
- 1.1 : Perspective
- 1.2 : Perspective
- 1.3 : Front
- 1.4 : Top
- 1.5 : Bottom
- 1.6 : Left
- 1.7 : Right

The shading in the figures show contour, not surface ornamentation, and form no part of the claimed design; the dashed lines shown in the figures are for illustration only and form no part of the claimed design.

1 Claim, 7 Drawing Sheets

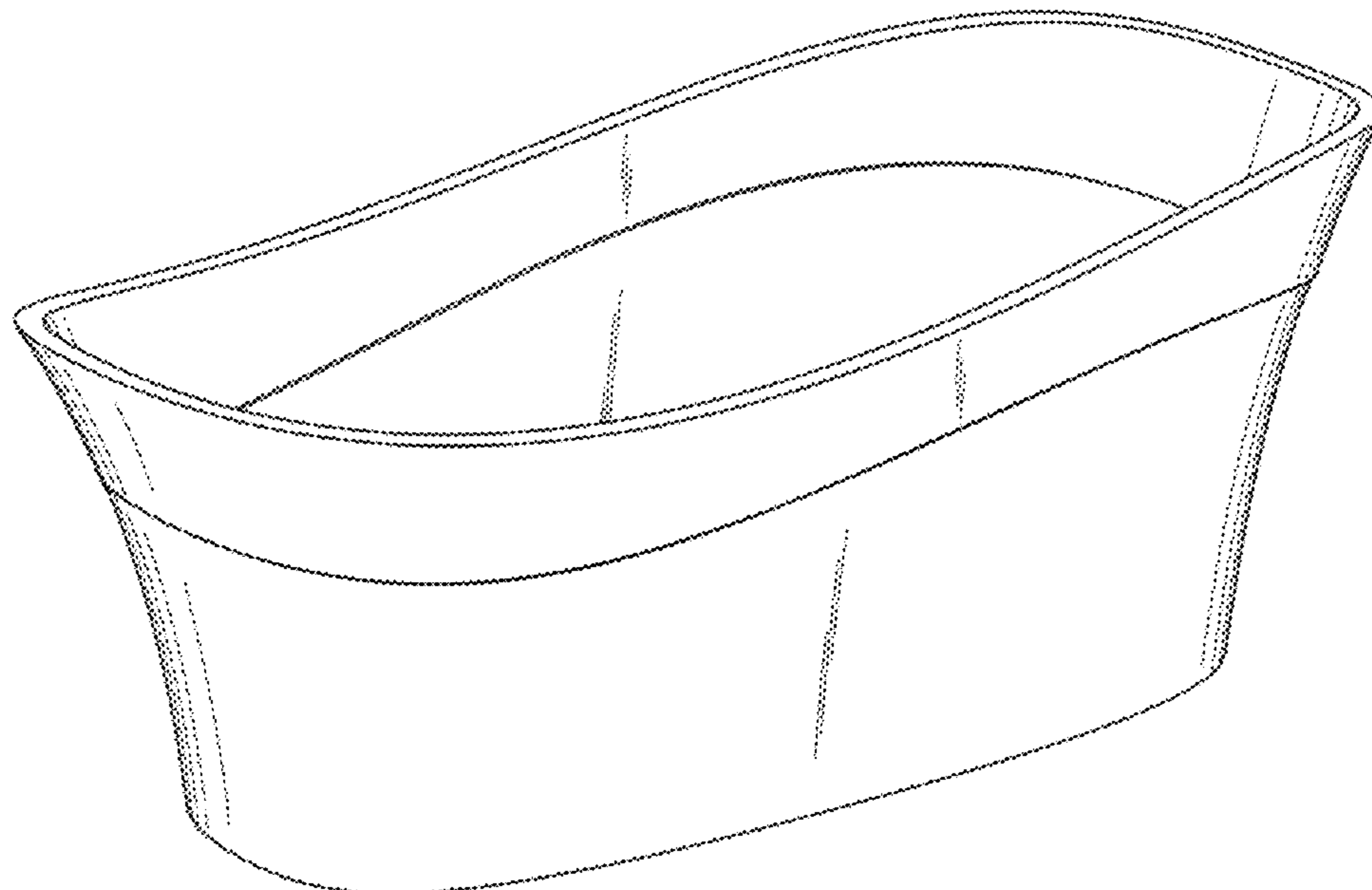

1.1

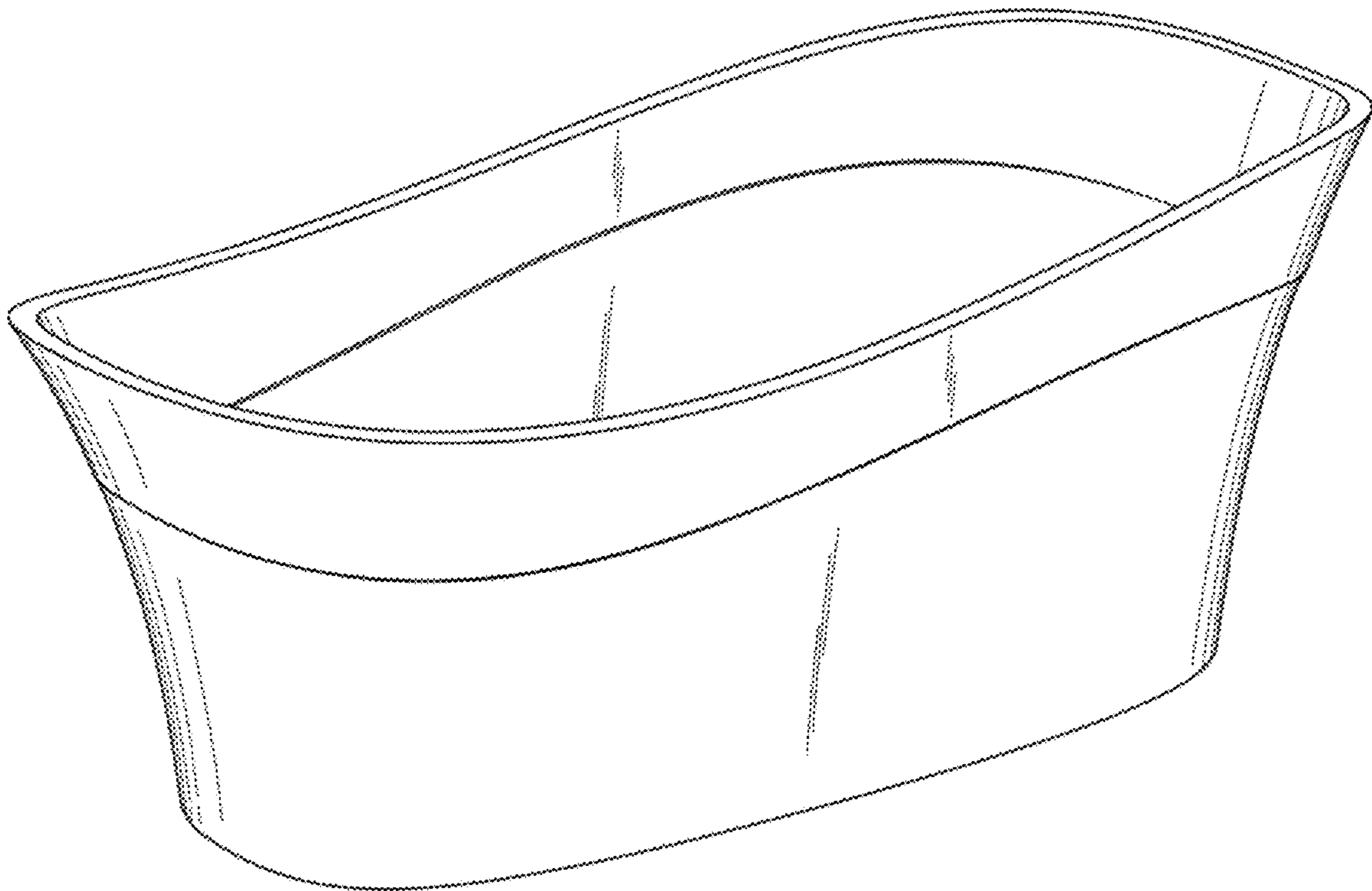

1.2

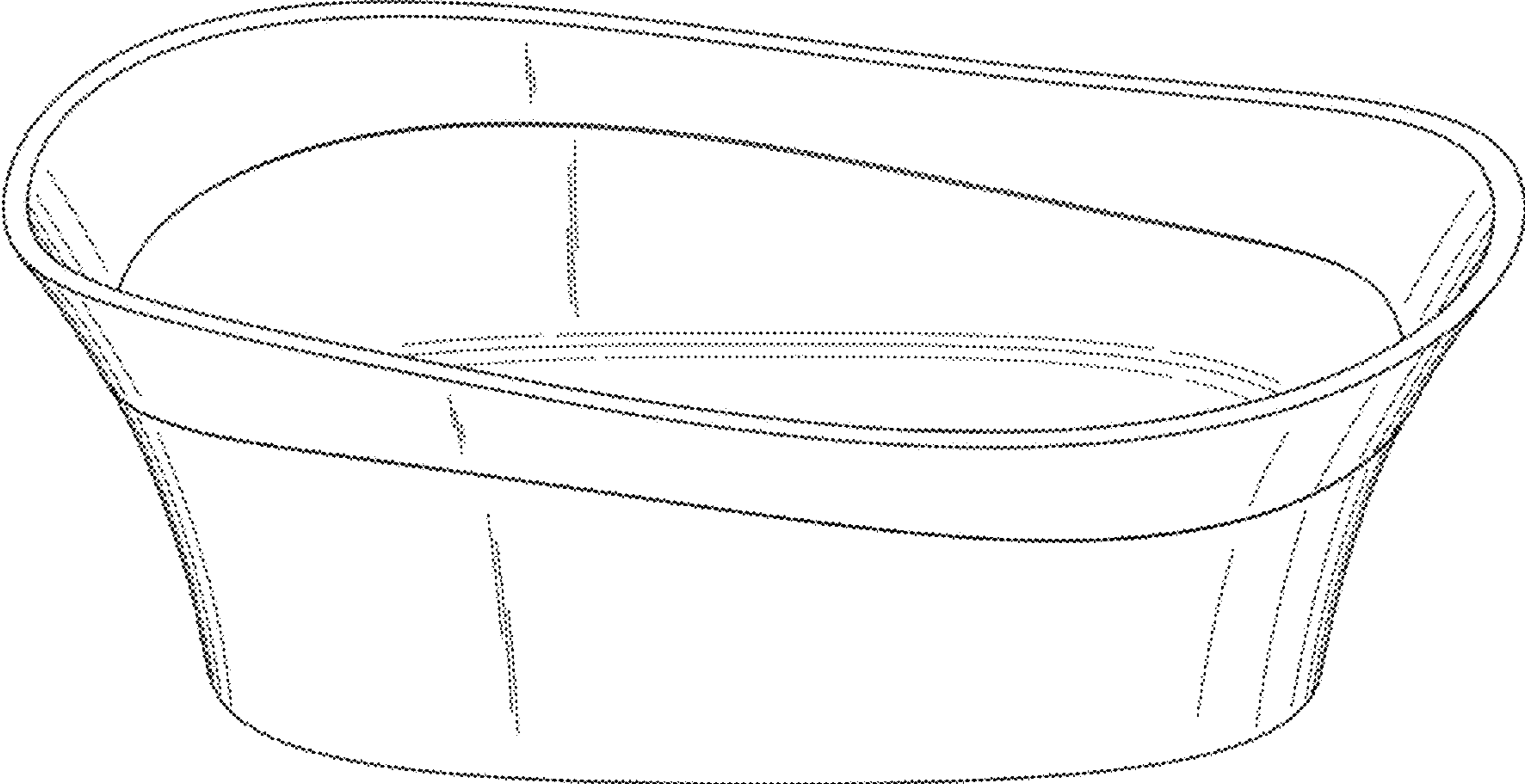

1.3

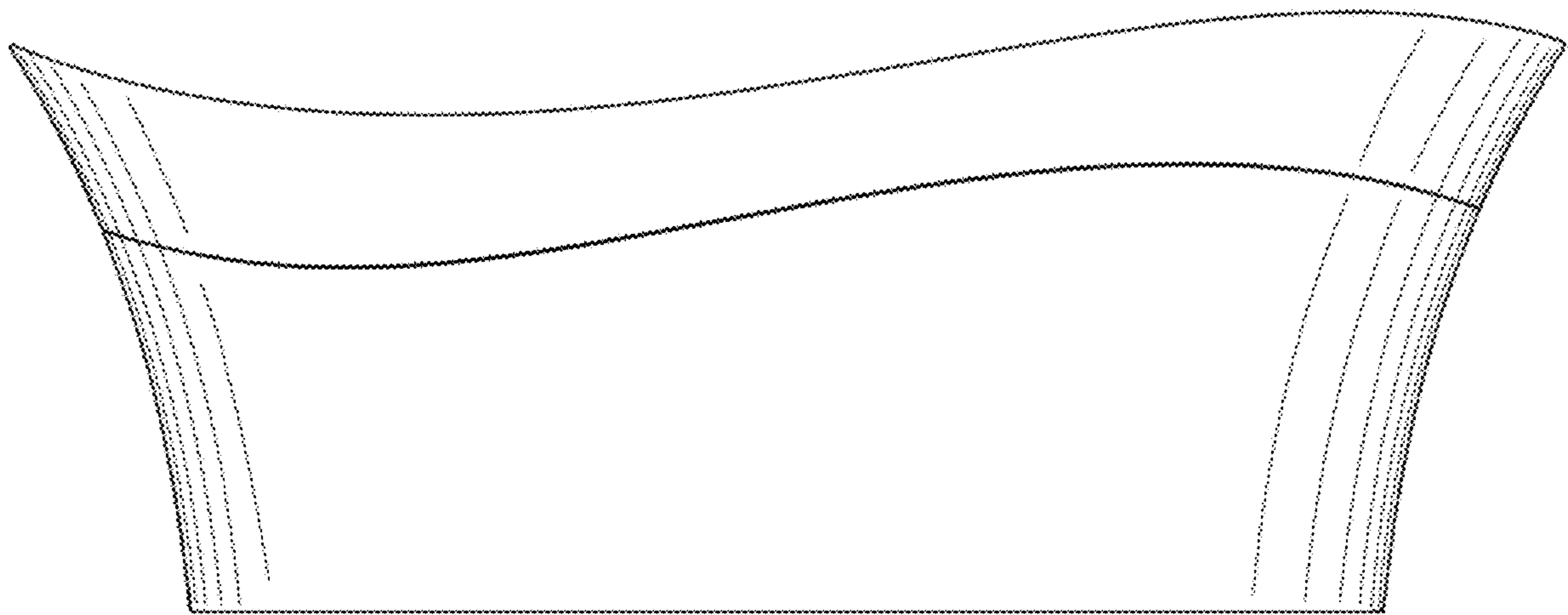

1.4

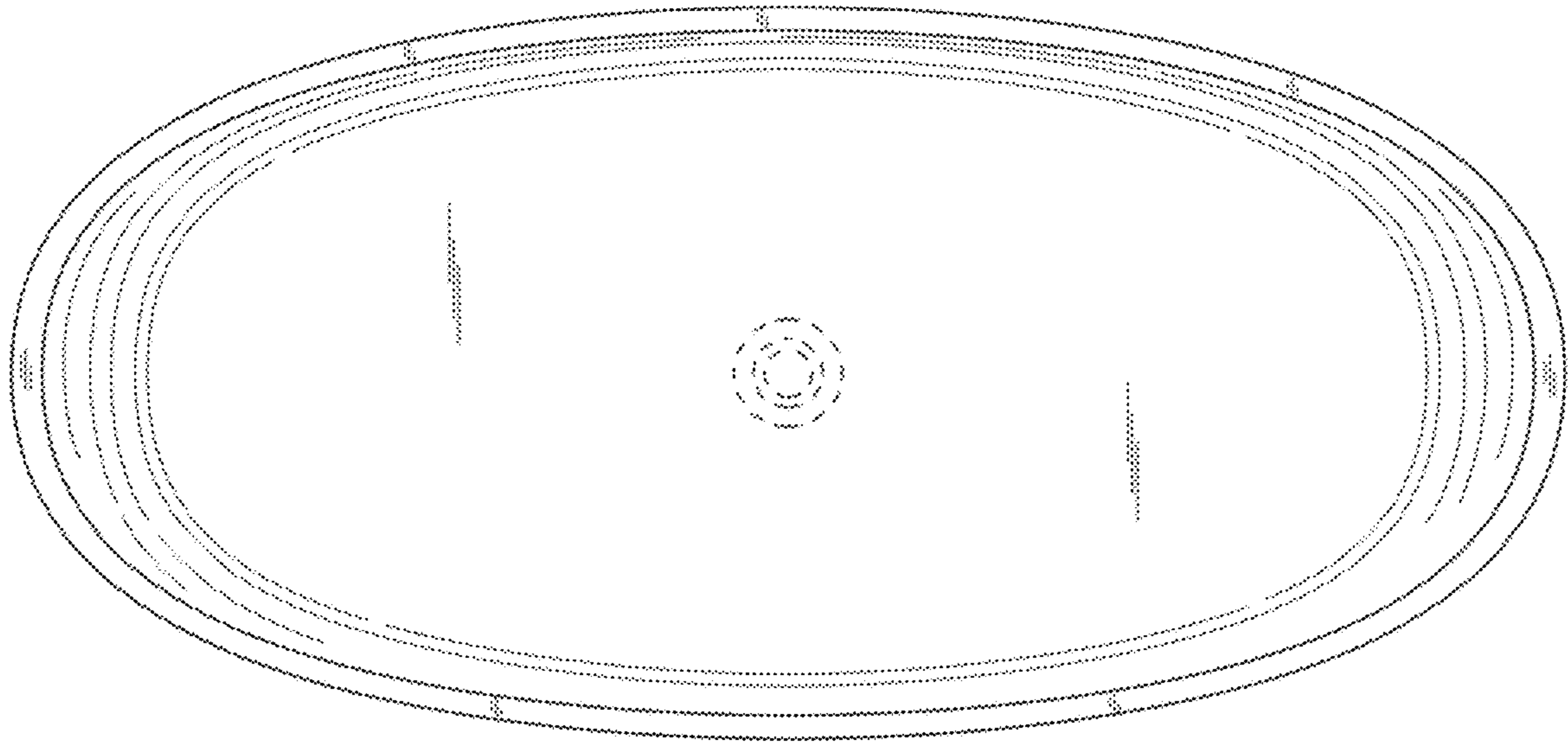

1.5

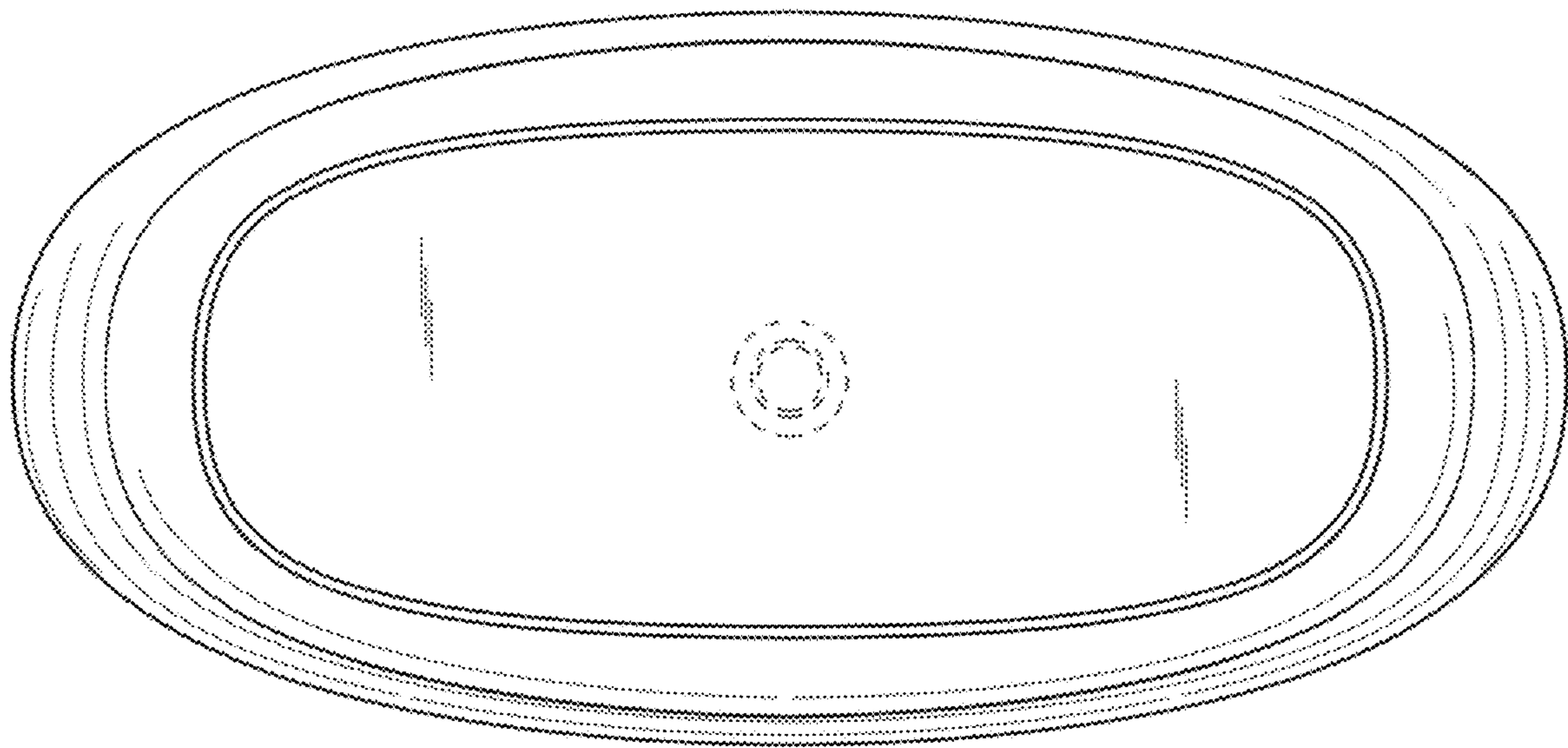

1.6

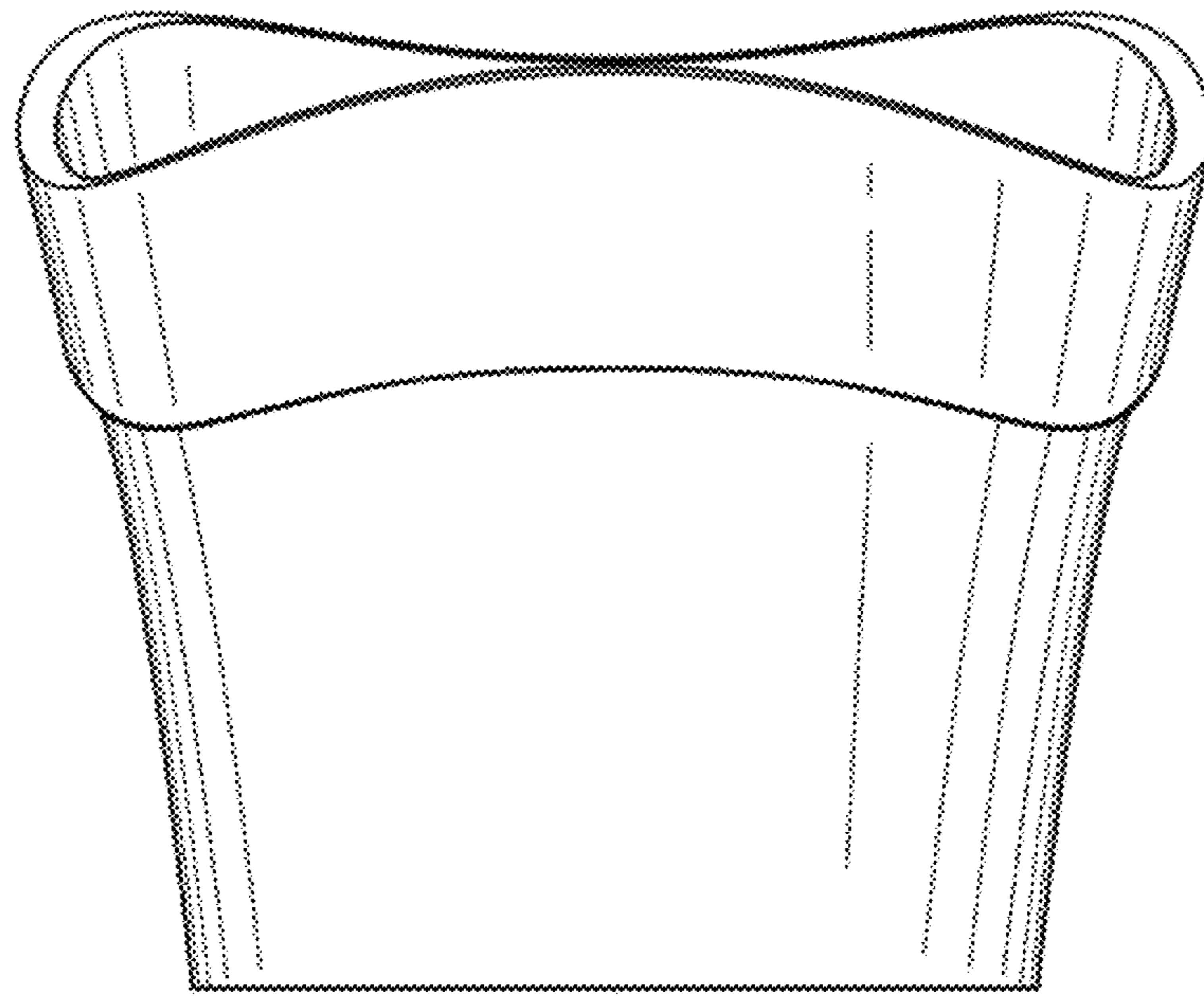

1.7

