



US00D794150S

(12) **United States Design Patent** (10) **Patent No.:** **US D794,150 S**  
**Ji** (45) **Date of Patent:** **\*\* Aug. 8, 2017**

(54) **TRAMPOLINE** 7,481,740 B2 \* 1/2009 Colling ..... A63B 5/11  
482/27  
(71) Applicant: **FULOO, LLC**, Santa Ana, CA (US) D614,715 S \* 4/2010 Mann ..... D21/797  
7,708,667 B2 5/2010 Alexander  
(72) Inventor: **Kiki Ji**, Newport Beach, CA (US) 7,758,471 B2 7/2010 Nelson  
7,794,360 B2 \* 9/2010 Publicover ..... A63B 5/11  
482/27  
(73) Assignee: **FULOO, LLC**, Santa Ana, CA (US) 7,850,575 B1 \* 12/2010 Hsiang ..... A63B 71/022  
482/27  
(\*\*) Term: **15 Years** D630,285 S \* 1/2011 Hsiang ..... D21/797  
(Continued)

(21) Appl. No.: **29/568,406**

(22) Filed: **Jun. 17, 2016**

(51) **LOC (10) Cl.** ..... **21-02**

(52) **U.S. Cl.**

USPC ..... **D21/797**

(58) **Field of Classification Search**

USPC ..... D21/797, 668, 669, 834, 826;  
D6/582-594, 716; 482/27, 35, 29, 112,  
482/33, 110, 148, 28, 77, 147, 51;  
297/23, 26, 452.18; 135/96, 117;  
D30/112; D25/1, 16, 22, 56; 446/220;  
473/469; 182/139, 224; 273/395, 402;  
D8/21, 29, 14; 81/124.6, 63.1, 177.85,  
81/125.1, 177.2

CPC . A63B 21/023; A63B 71/022; A63B 2208/12;  
A63B 2210/50

See application file for complete search history.

(56) **References Cited**

**U.S. PATENT DOCUMENTS**

4,900,011 A \* 2/1990 Nolet ..... A47D 13/063  
482/29  
5,399,132 A 3/1995 Bailey  
5,941,798 A 8/1999 Coan et al.  
6,053,845 A \* 4/2000 Publicover ..... A63B 5/11  
482/27  
6,135,922 A 10/2000 Nissen  
6,261,207 B1 7/2001 Publicover et al.  
6,607,468 B1 \* 8/2003 Nichols, Jr. .... A63B 5/11  
482/27  
D570,947 S \* 6/2008 Horne ..... D21/797

**OTHER PUBLICATIONS**

Skybound by Trampoline parts center dated no date given. Found online [Jan. 18, 2017] [http://trampolinepartscenter.com/trampolines/full-size-trampolines/skybound-stratos-12ft-trampoline-with-full-enclosure.\\*](http://trampolinepartscenter.com/trampolines/full-size-trampolines/skybound-stratos-12ft-trampoline-with-full-enclosure.*)

(Continued)

*Primary Examiner* — Robert M Spear  
*Assistant Examiner* — Ryan Harvey  
(74) *Attorney, Agent, or Firm* — Innovation Capital Law Group, LLP; Vic Lin

(57) **CLAIM**

The ornamental design for a trampoline, as shown and described.

**DESCRIPTION**

FIG. 1 is a top perspective view of a trampoline;  
FIG. 2 is a bottom perspective view thereof;  
FIG. 3 is a top plan view thereof;  
FIG. 4 is a bottom plan view thereof;  
FIG. 5 is a right elevation view thereof;  
FIG. 6 is a left elevation view thereof;  
FIG. 7 is a front elevation view thereof; and,  
FIG. 8 is a rear elevation view thereof.  
The dash-dot-dot-dash lines depict contours and form part of the claim.

**1 Claim, 8 Drawing Sheets**

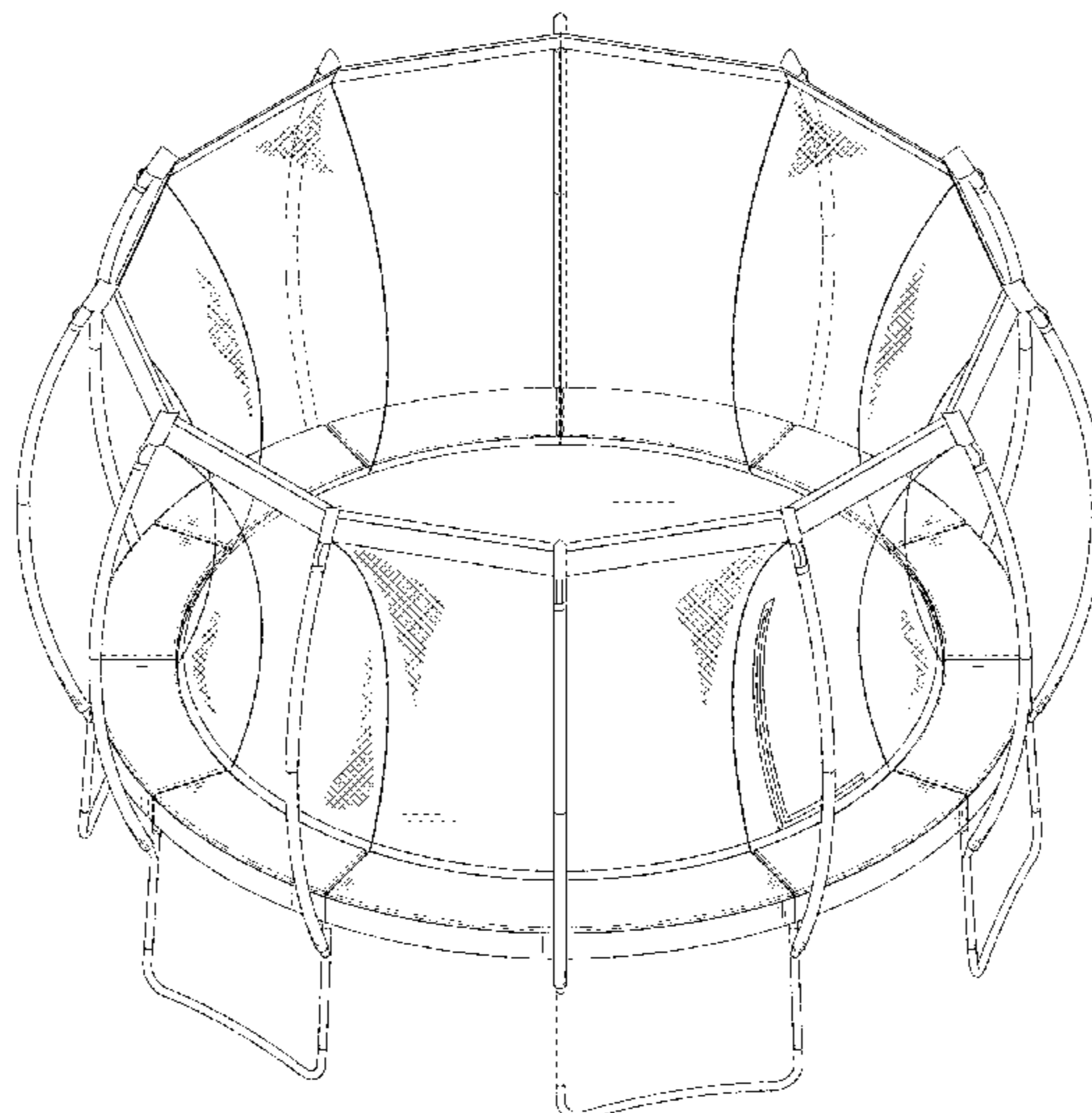

(56)

References Cited

U.S. PATENT DOCUMENTS

7,883,446 B2 \* 2/2011 Lovley, II ..... A63B 5/11  
482/27  
8,012,066 B1 \* 9/2011 Hsiang ..... A63B 5/11  
482/27  
D653,299 S \* 1/2012 Samuel ..... D21/797  
D664,228 S \* 7/2012 Hsiang ..... D21/797  
D684,233 S \* 6/2013 Yang ..... D21/797  
8,764,610 B2 7/2014 Chen et al.  
D712,497 S \* 9/2014 Yang ..... D21/797  
D717,899 S \* 11/2014 Chen ..... D21/797  
D718,827 S \* 12/2014 Chen ..... D21/797  
8,920,290 B2 12/2014 Stokes et al.  
9,084,908 B1 \* 7/2015 Chen ..... A63B 5/11  
9,089,732 B2 \* 7/2015 Andon ..... A63B 5/11  
D755,914 S \* 5/2016 Andon ..... D21/797  
2002/0137598 A1 \* 9/2002 Publicover ..... A63B 5/11  
482/27  
2004/0121883 A1 \* 6/2004 Publicover ..... A63B 5/11  
482/29  
2005/0079954 A1 \* 4/2005 Wang ..... A63B 5/11  
482/27  
2006/0189442 A1 \* 8/2006 Publicover ..... A63B 5/11  
482/27  
2007/0004559 A1 \* 1/2007 Alexander ..... A63B 5/11  
482/27  
2007/0004560 A1 \* 1/2007 Nelson ..... A63B 5/11  
482/29  
2008/0269020 A1 \* 10/2008 Alexander ..... A63B 5/11  
482/29  
2008/0314427 A1 \* 12/2008 Lai ..... A63H 33/008  
135/96  
2012/0077642 A1 \* 3/2012 Chen ..... A63B 5/11  
482/27  
2012/0289379 A1 \* 11/2012 Stokes ..... A63B 5/11  
482/27

2013/0005537 A1 \* 1/2013 Chen ..... A63B 5/11  
482/27  
2013/0072269 A1 \* 3/2013 Chen ..... A63B 5/11  
463/7  
2013/0109539 A1 \* 5/2013 Chen ..... A63B 5/11  
482/27  
2014/0038678 A1 \* 2/2014 Chen ..... A63B 69/0053  
463/7  
2014/0221162 A1 \* 8/2014 Chen ..... A63B 43/005  
482/27  
2014/0228176 A1 \* 8/2014 Miller ..... A63B 5/11  
482/27  
2014/0336005 A1 \* 11/2014 Miller ..... A63B 5/11  
482/27  
2015/0051049 A1 \* 2/2015 Andon ..... A63B 5/11  
482/29  
2015/0157889 A1 \* 6/2015 Miller ..... A63B 5/11  
482/27  
2016/0045775 A1 \* 2/2016 Zhou ..... A63B 5/11  
482/27  
2016/0121153 A1 \* 5/2016 Liu ..... A63B 5/11  
482/27  
2016/0121154 A1 \* 5/2016 Liu ..... A63B 5/11  
482/29  
2016/0136473 A1 \* 5/2016 Chen ..... A63B 5/11  
482/29

OTHER PUBLICATIONS

Office Action dated Jan. 27, 2017 from related U.S. Appl. No. 29/568,415, 9 pages.  
Skybound by Trampoline parts center dated no date given. Found on line [Jan. 18, 2017]<http://trampolinepartscenter.com/trampolines/full-size-trampolines/skybound-atmos-8ft-trampoline#>.

\* cited by examiner

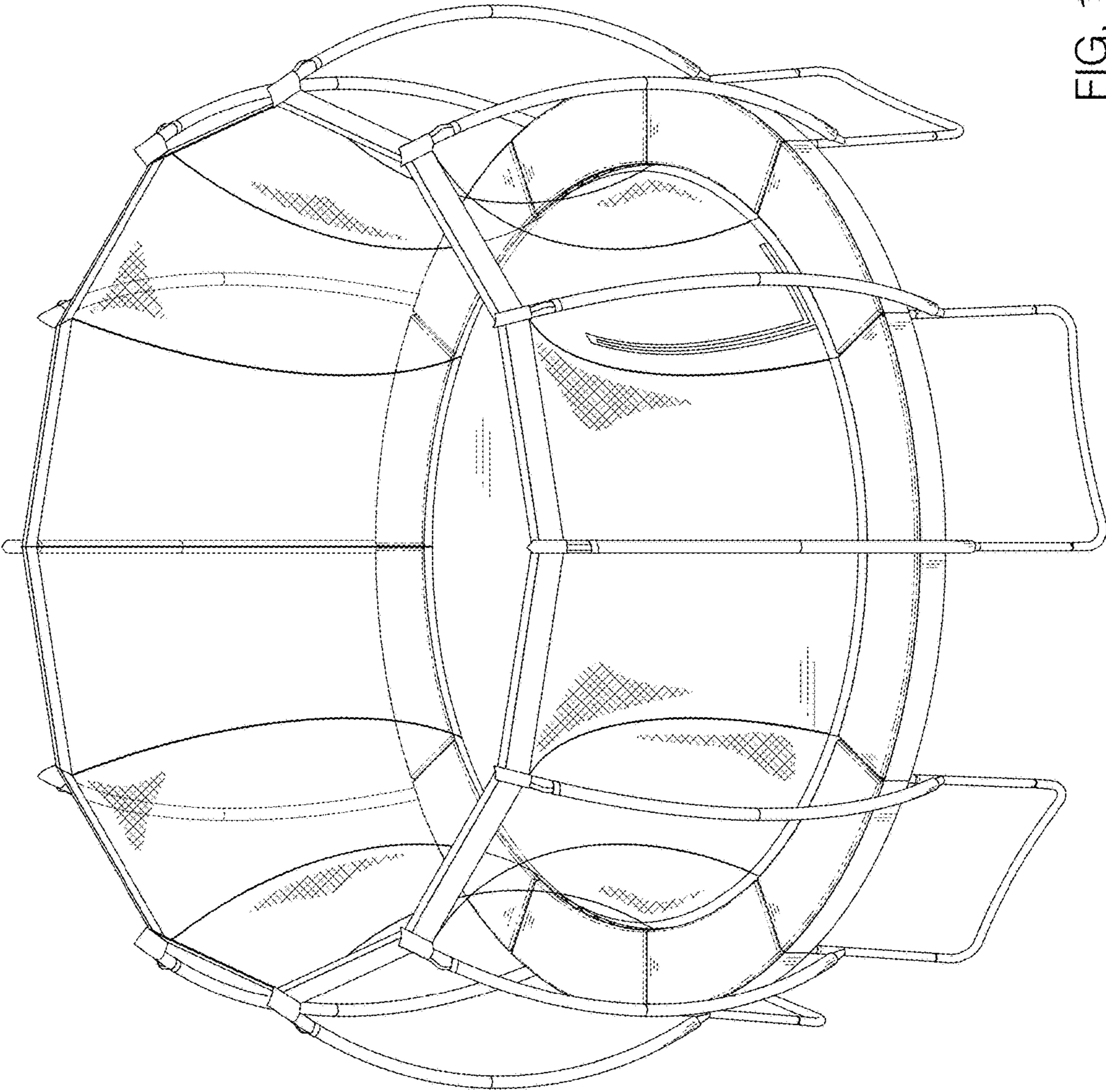

FIG. 1

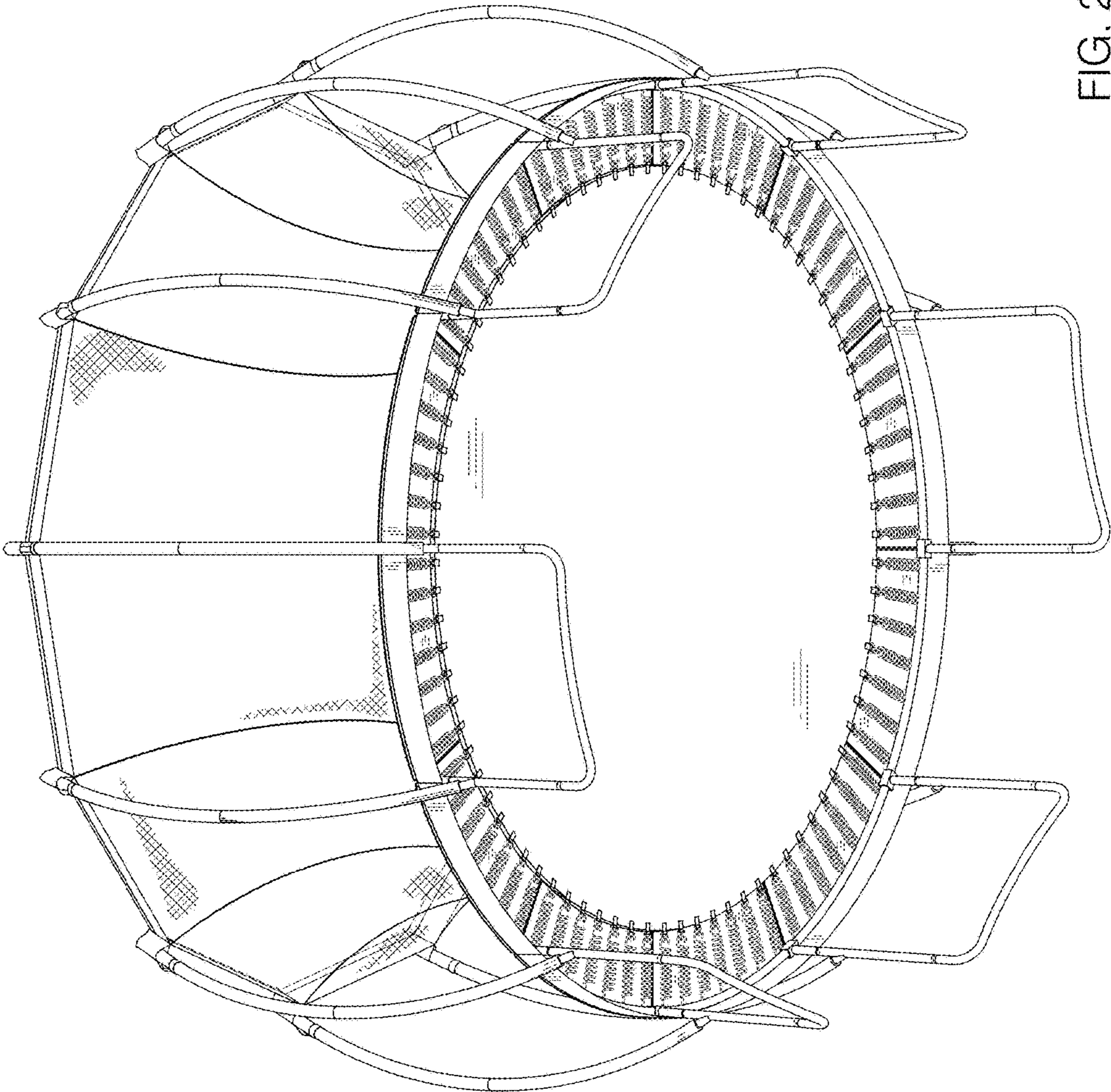

FIG. 2

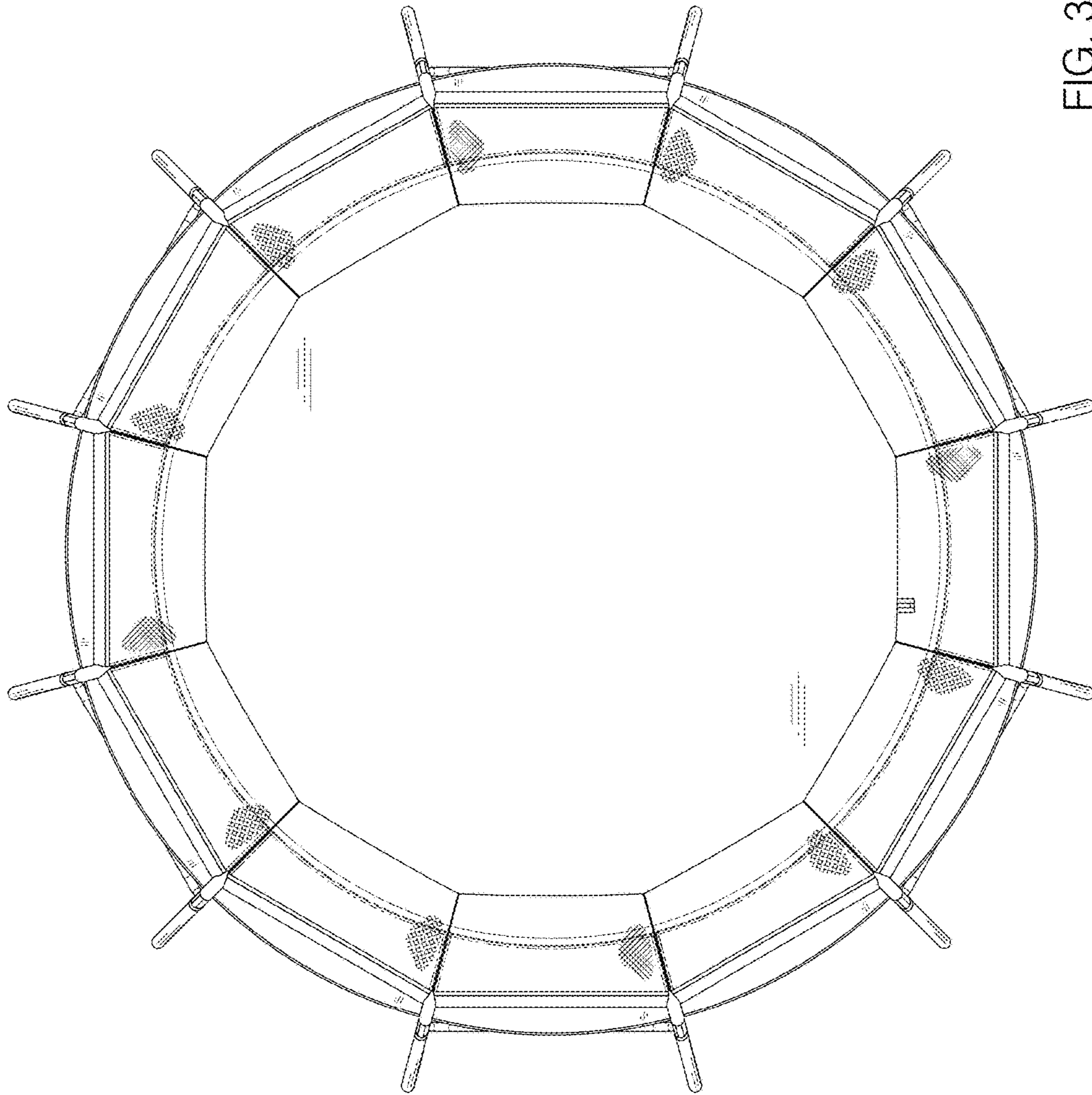

FIG. 3

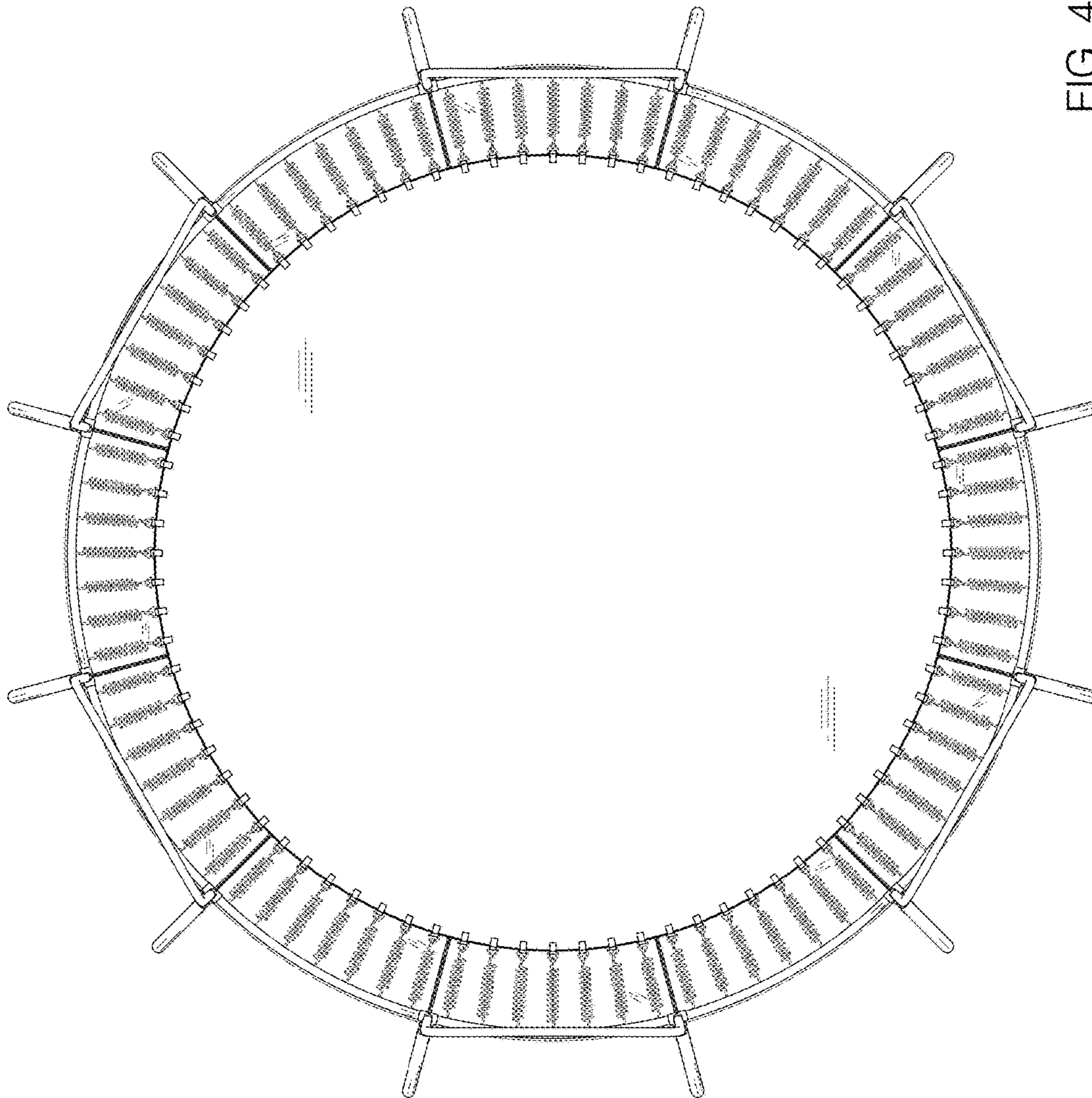

FIG. 4

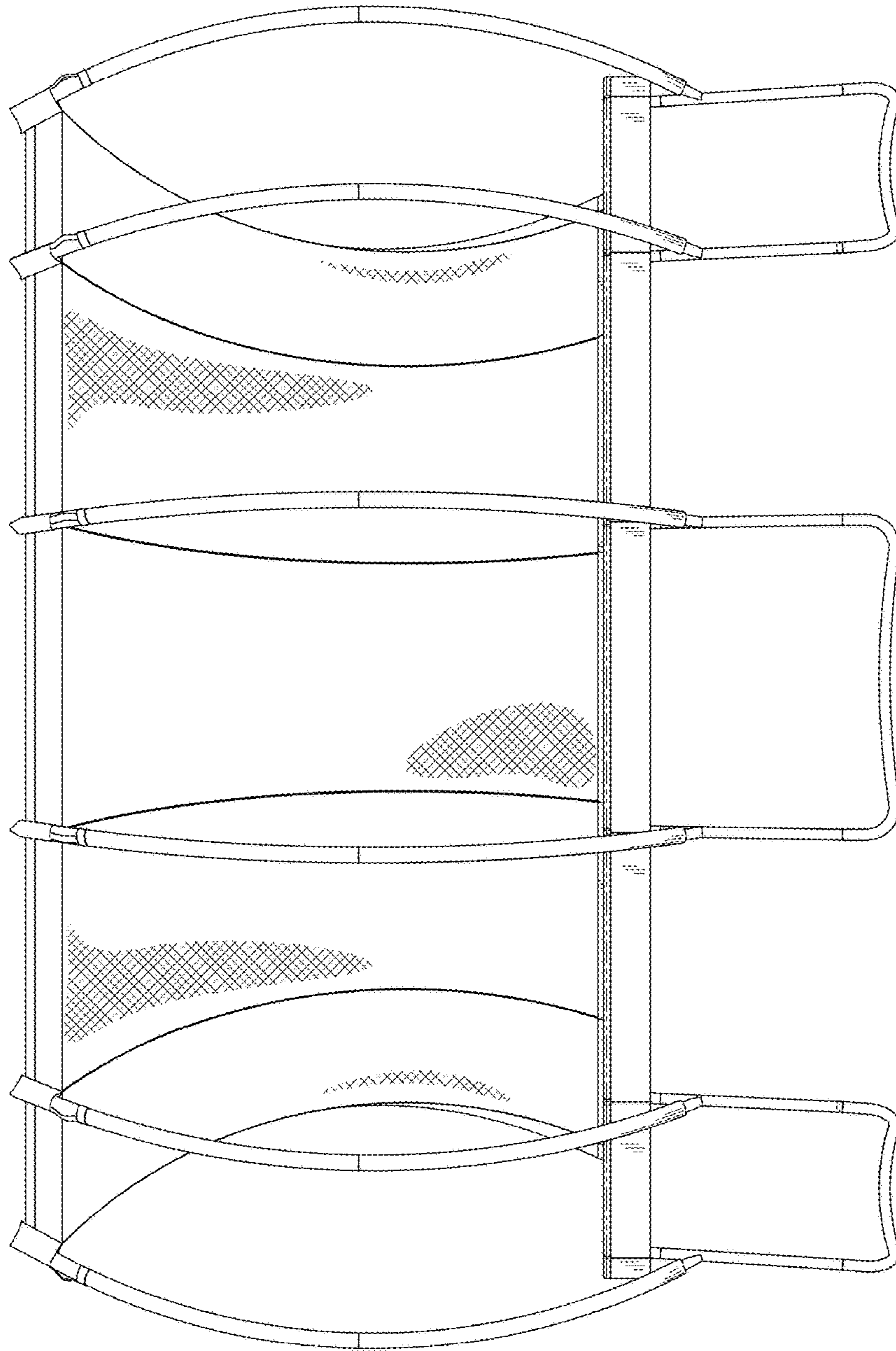

FIG. 5

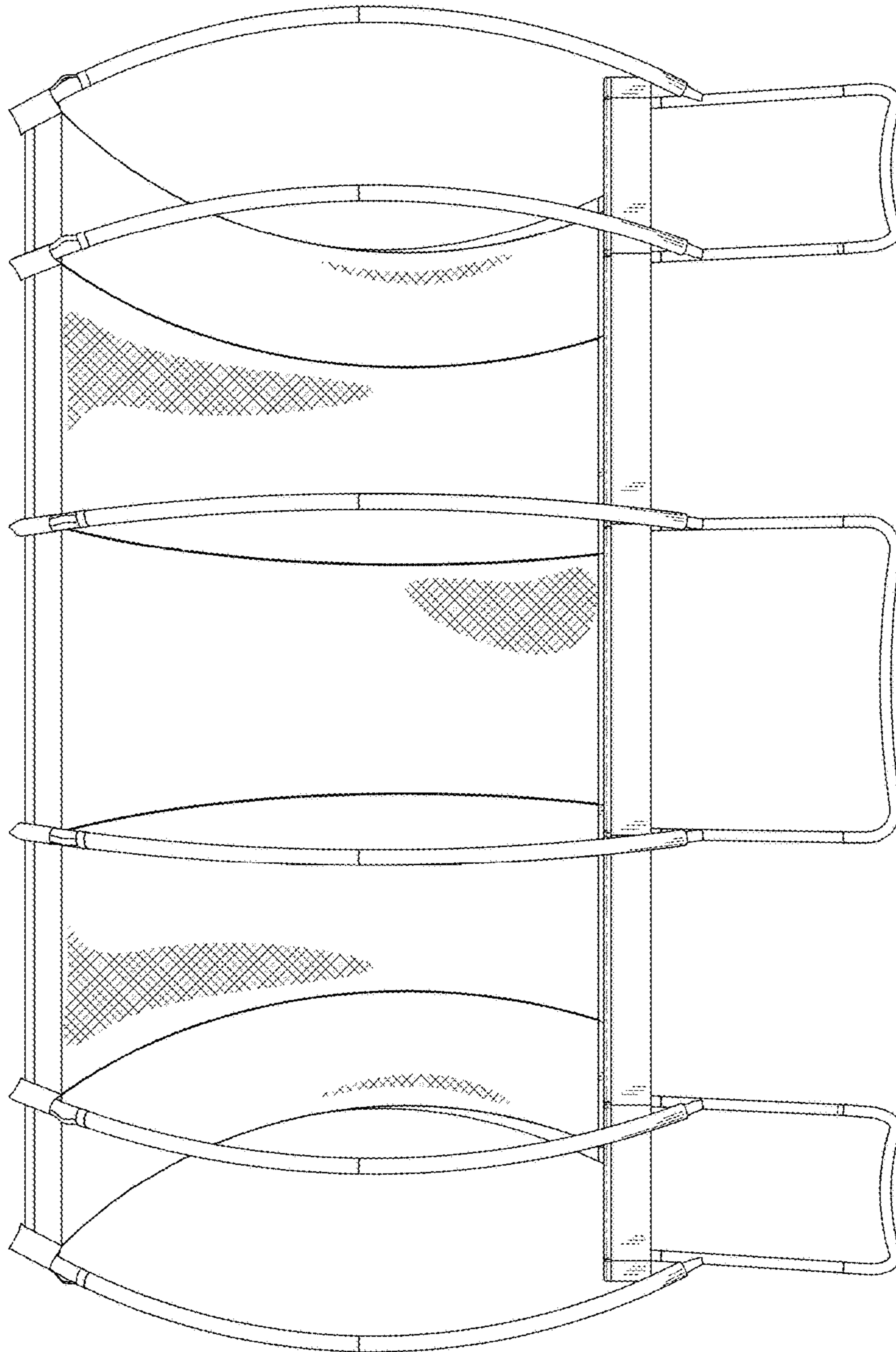

FIG. 6



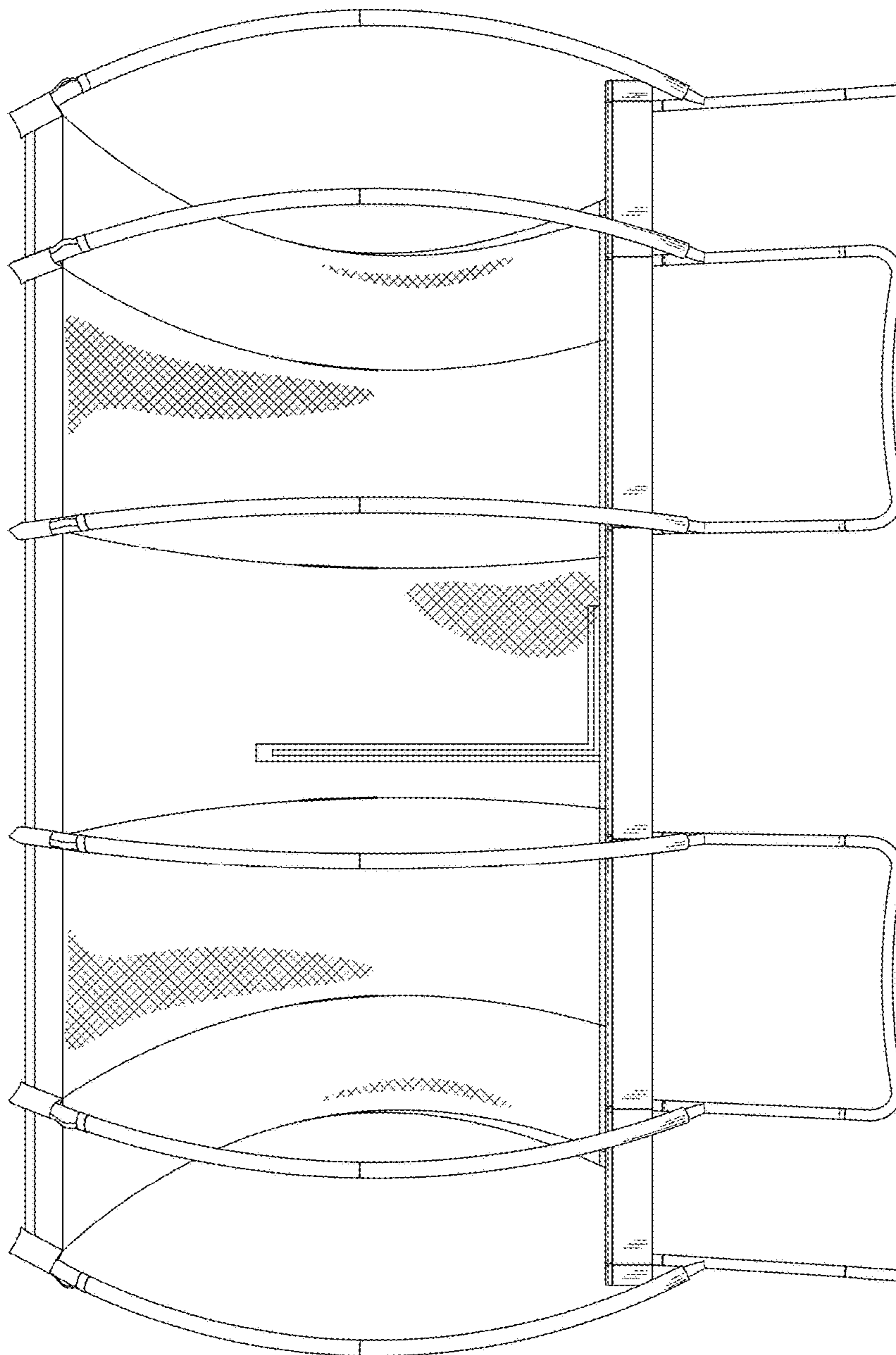

FIG. 7

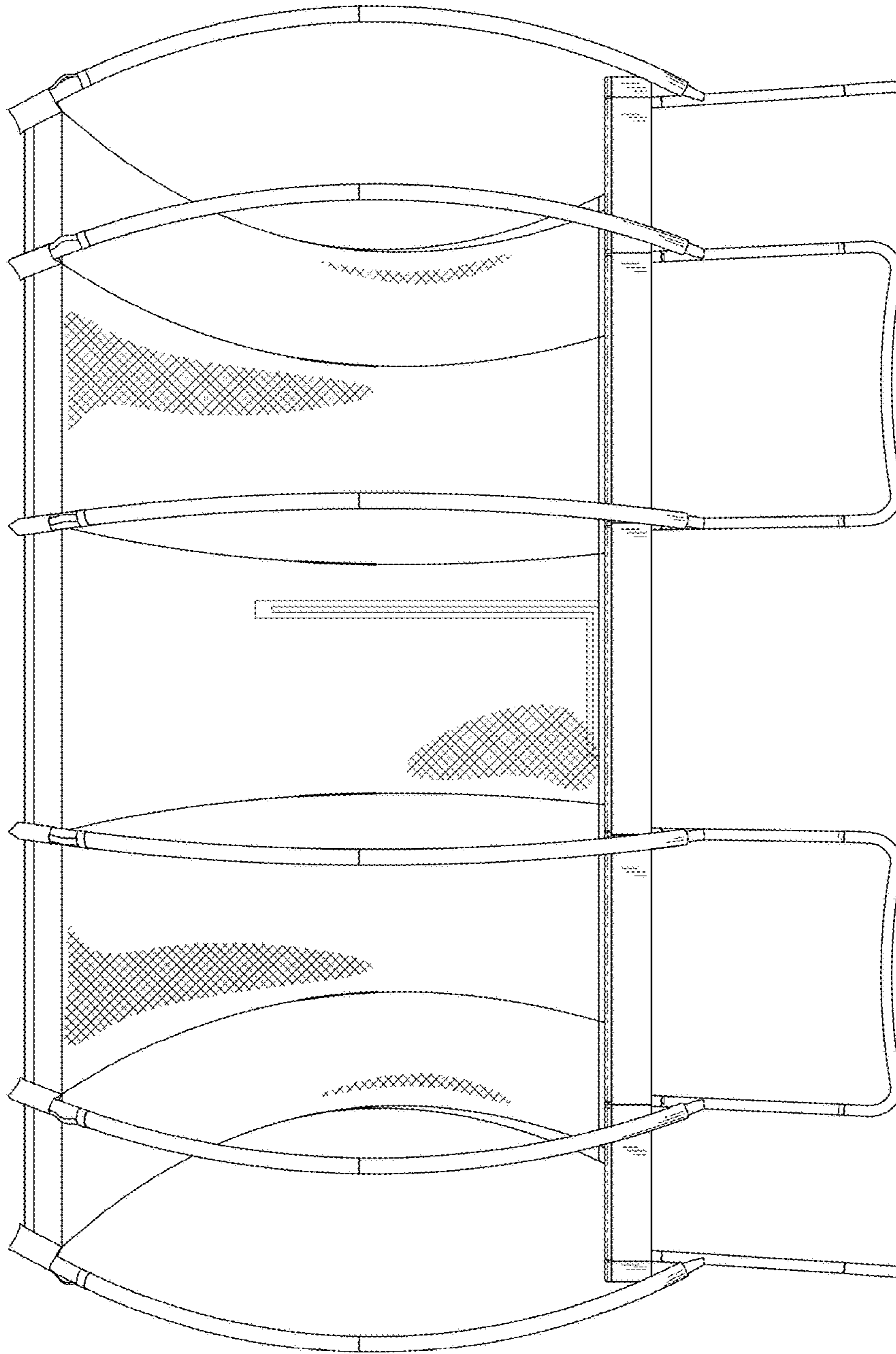

FIG. 8