



US00D794024S

(12) **United States Design Patent**
Kujawski et al.

(10) **Patent No.:** **US D794,024 S**
(45) **Date of Patent:** **** Aug. 8, 2017**

(54) **DIRECTIONAL PAD FOR A CONTROLLER**

FOREIGN PATENT DOCUMENTS

(71) Applicant: **Microsoft Corporation**, Redmond, WA
(US)

JP D1297485 4/2007
JP D1424810 10/2011

(Continued)

(72) Inventors: **Christopher Kujawski**, Seattle, WA
(US); **Kenneth Jasinski**, Bellevue, WA
(US)

OTHER PUBLICATIONS

Side-by-side: Xbox One Gamepad vs Xbox 360 gamepad (Jun. 11, 2013), <http://www.techradar.com/us/news/gaming/consoles/side-by-side-xbox-one-gamepad-vs-xbox-360-gamepad-1158091>.

(Continued)

(73) Assignee: **Microsoft Corporation**, Redmond, WA
(US)

(**) Term: **15 Years**

Primary Examiner — Freda S Nunn

(21) Appl. No.: **29/543,897**

(74) *Attorney, Agent, or Firm* — Banner & Witcoff, Ltd.

(22) Filed: **Oct. 29, 2015**

(57) **CLAIM**

The ornamental design for a directional pad for a controller, as shown and described.

(51) **LOC (10) Cl.** **14-03**

(52) **U.S. Cl.**

USPC **D14/401**

(58) **Field of Classification Search**

USPC D13/103, 108, 158; D14/203.1–203.2,
D14/356, 400, 401, 412–417, 454–456,
D14/507; D21/324, 329, 333, 566

CPC A63F 13/00; A63F 13/02; A63F 13/06;
A63F 9/00; A63F 17/00; A63F 19/00;
A63F 9/24; A63F 71/00; A63F 13/005;
A63F 13/24; G09G 5/00; G09G 5/08;
G11B 19/02; G06F 19/00; G08C 23/04;
H04B 7/00

See application file for complete search history.

DESCRIPTION

FIG. 1 is a front perspective view of a directional pad for a controller showing our new design;

FIG. 2 is a top view thereof;

FIG. 3 is a bottom view thereof;

FIG. 4 is a rear view thereof;

FIG. 5 is a front view thereof;

FIG. 6 is a left side view thereof;

FIG. 7 is a right side view thereof;

FIG. 8 is a front perspective view of the directional pad for a controller of FIGS. 1-7 shown in an unclaimed controller environment;

FIG. 9 is a top view thereof;

FIG. 10 is a rear view thereof;

FIG. 11 is a front view thereof;

FIG. 12 is a left side view thereof; and,

FIG. 13 is a right side view thereof.

The broken line showing of the various unshaded elements of the directional pad for a controller in FIGS. 1-13 is for environmental purposes only and forms no part of the claimed design.

(56) **References Cited**

U.S. PATENT DOCUMENTS

D273,246 S 4/1984 Tonkel
D368,936 S 4/1996 Goto
D373,108 S 8/1996 Chung
5,551,693 A * 9/1996 Goto A63F 13/06
345/169

(Continued)

1 Claim, 10 Drawing Sheets

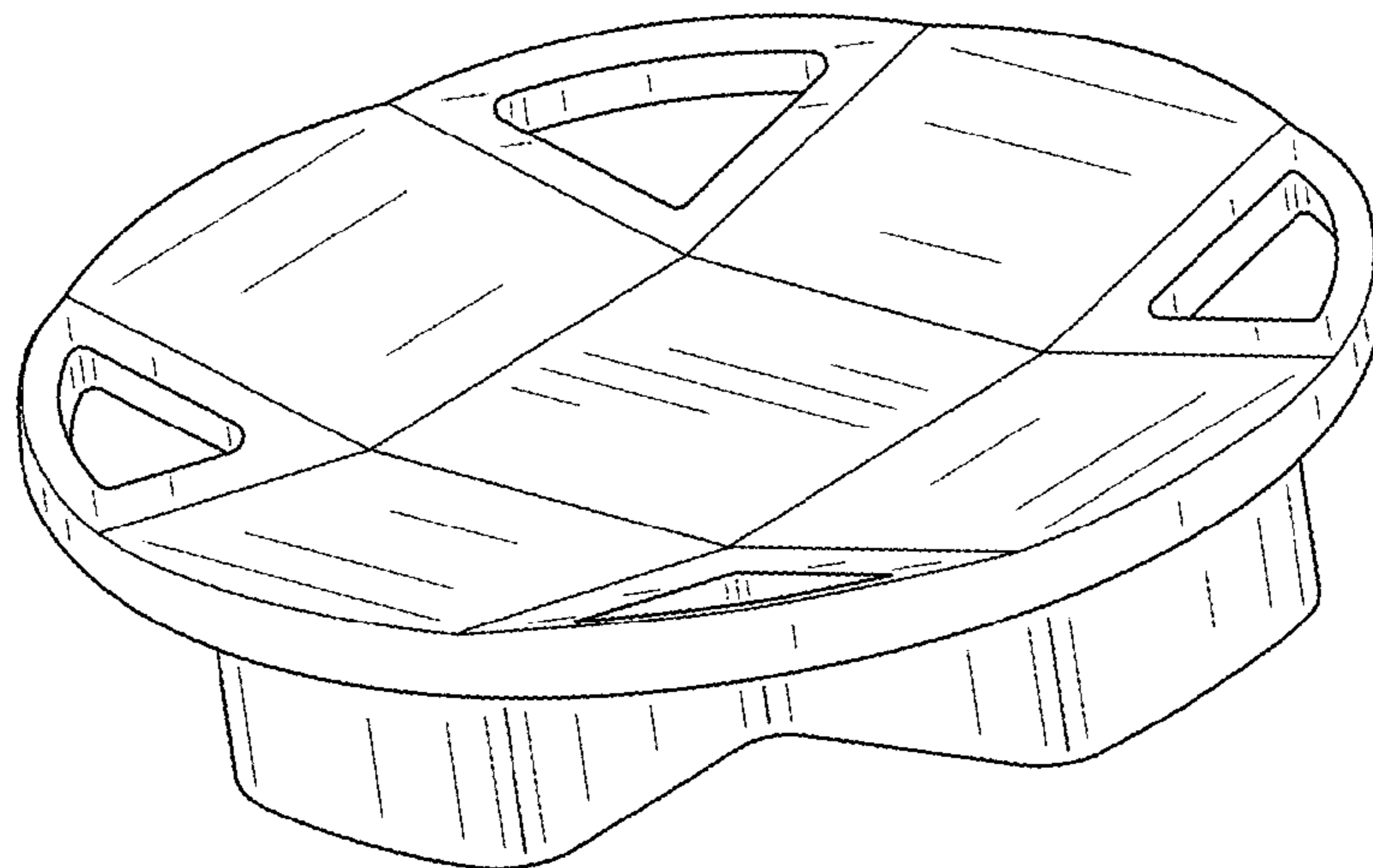

(56)

References Cited

U.S. PATENT DOCUMENTS

D398,214 S 9/1998 Yui
 5,923,317 A * 7/1999 Saylor A63F 13/06
 345/156
 D415,485 S * 10/1999 Leifer D14/401
 D415,752 S 10/1999 Tyler et al.
 D423,448 S 4/2000 Yu
 D424,047 S 5/2000 Chan
 D430,222 S * 8/2000 Goto D14/432
 6,120,374 A * 9/2000 Akada A63F 13/005
 463/3
 D435,551 S 12/2000 Hayes
 6,231,444 B1 5/2001 Goto et al.
 D449,042 S 10/2001 Chung
 D453,932 S 2/2002 Han et al.
 6,463,159 B1 10/2002 Ming-Cheng
 D467,922 S 12/2002 Lee
 D469,436 S * 1/2003 Hussaini D14/401
 D476,376 S 6/2003 Wintersteiger
 6,572,108 B1 6/2003 Bristow
 6,743,100 B1 * 6/2004 Neiser A63F 13/06
 273/148 B
 6,956,559 B2 10/2005 Hagiwara et al.
 6,968,070 B1 11/2005 Chiang
 D521,015 S 5/2006 Hayes et al.
 D522,011 S 5/2006 Hayes et al.
 D522,012 S 5/2006 Hayes et al.
 7,063,321 B2 6/2006 Hussaini et al.
 D524,244 S 7/2006 Hussaini et al.
 7,105,754 B2 9/2006 Turner
 D533,011 S 12/2006 Pai
 7,195,561 B2 3/2007 Hussaini et al.
 D545,317 S 6/2007 Wang et al.
 7,235,012 B2 6/2007 DiDato
 D547,763 S 7/2007 Hayes et al.
 D556,201 S 11/2007 Ashida et al.
 7,314,413 B2 1/2008 Ogata et al.
 D563,480 S 3/2008 Blaseflug et al.
 D565,668 S 4/2008 Baseflug et al.
 D568,335 S 5/2008 Armstrong et al.
 D569,388 S 5/2008 Armstrong et al.
 D576,545 S 9/2008 Mandel et al.
 D581,422 S 11/2008 Hayes et al.
 7,445,550 B2 11/2008 Barney et al.
 D585,931 S * 2/2009 Palmer D14/401
 D601,564 S 10/2009 Maeno
 D619,596 S 7/2010 Maitlen et al.
 7,762,553 B2 7/2010 Harris
 D624,049 S 9/2010 Liu
 7,887,768 B2 2/2011 Honjo et al.
 D636,773 S 4/2011 Lin
 D637,153 S 5/2011 Ikeda et al.
 D638,016 S 5/2011 Ikeda
 D646,275 S 10/2011 Ikeda et al.
 8,040,671 B2 10/2011 Iwamoto et al.
 D650,795 S 12/2011 Koehn
 D655,350 S 3/2012 Taniguchi et al.
 D658,178 S 4/2012 Ikeda et al.
 D658,179 S * 4/2012 Ikeda D14/401
 D659,140 S 5/2012 Ikeda et al.
 8,241,124 B2 8/2012 Kelly et al.
 D667,892 S 9/2012 Burgess et al.
 D685,434 S 7/2013 Ali et al.
 8,487,876 B2 7/2013 Ikeda et al.
 D692,001 S 10/2013 Ibuki et al.
 8,545,323 B2 10/2013 McVicar et al.
 D692,887 S 11/2013 Ibuki et al.
 D694,830 S 12/2013 Crowley et al.
 D700,182 S 2/2014 Kidakarn
 8,641,525 B2 2/2014 Burgess et al.
 D707,758 S 6/2014 Norman et al.
 D708,615 S 7/2014 Delrue et al.
 D709,498 S 7/2014 Morris et al.
 D709,499 S 7/2014 Morris et al.
 D709,882 S 7/2014 Morris et al.
 D712,973 S 9/2014 Sumii et al.

D715,865 S 10/2014 Morris et al.
 D718,705 S 12/2014 Naksen
 D718,818 S 12/2014 Sumii et al.
 8,903,100 B2 12/2014 Hiraki
 8,903,111 B2 12/2014 Garet et al.
 8,925,414 B1 1/2015 Park et al.
 8,994,666 B2 3/2015 Karpfinger
 D730,451 S 5/2015 Burgess et al.
 9,029,721 B2 5/2015 Ikeda et al.
 9,053,243 B2 6/2015 Townsend
 D733,802 S 7/2015 Burgess et al.
 D735,721 S 8/2015 Mar
 D736,322 S 8/2015 Navid
 9,118,750 B2 8/2015 Vossoughi et al.
 D740,825 S * 10/2015 Bellinghausen D14/401
 D745,607 S 12/2015 Jones
 D748,734 S 2/2016 Burgess et al.
 9,251,701 B2 2/2016 Plagge et al.
 D754,128 S 4/2016 Bellinghausen et al.
 D763,967 S 8/2016 Kujawski et al.
 D764,597 S 8/2016 Kujawski et al.
 D765,787 S 9/2016 Kujawski et al.
 D765,788 S 9/2016 Kujawski et al.
 D765,790 S 9/2016 Chatterjee et al.
 D765,791 S 9/2016 Chatterjee et al.
 D765,792 S 9/2016 Chatterjee et al.
 D765,793 S 9/2016 Chatterjee et al.
 D766,374 S 9/2016 Kujawski et al.
 D766,375 S 9/2016 Kujawski et al.
 D766,376 S 9/2016 Kujawski et al.
 D766,377 S 9/2016 Kujawski et al.
 D767,038 S 9/2016 Kujawski et al.
 D767,684 S 9/2016 Kujawski et al.
 D768,784 S 10/2016 Kujawski et al.
 D770,568 S 11/2016 Kujawski et al.
 D772,987 S 11/2016 Kujawski et al.
 D772,988 S 11/2016 Kujawski et al.
 D773,561 S 12/2016 Kujawski et al.
 D774,143 S 12/2016 Kujawski et al.
 2006/0079328 A1 * 4/2006 Wang A63F 13/06
 463/37
 2006/0116204 A1 6/2006 Chen et al.
 2013/0130800 A1 * 5/2013 Sirilux A63F 13/24
 463/37

FOREIGN PATENT DOCUMENTS

JP D1492113 2/2014
 JP D1492114 3/2014
 JP D1492115 3/2014
 JP D1549312 4/2016
 JP D1551961 6/2016
 JP D1552375 6/2016
 KR 30-0751062-000 7/2014
 TW D165791 2/2015
 TW D165793 2/2015
 TW D177467 8/2016
 TW D177469 8/2016

OTHER PUBLICATIONS

May 2, 2016—(US) Notice of Allowance—U.S. Appl. No. 29/530,225, filed Jun. 15, 2015; Inv: Christopher Kujawski.
 May 11, 2016—(US) Restriction Requirement—U.S. Appl. No. 29/530,106, filed Jun. 15, 2015; Inv: Christopher Kujawski.
 May 10, 2016—(US) Restriction Requirement—U.S. Appl. No. 29/530,098, filed Jun. 15, 2015; Inv: Christopher Kujawski.
 May 17, 2016—(US) Notice of Allowance—U.S. Appl. No. 29/530,102, filed Jun. 12, 2015; Inv: Christopher Kujawski.
 May 6, 2016—(US) Notice of Allowance—U.S. Appl. No. 29/530,110, filed Jun. 12, 2015; Inv: Christopher Kujawski.
 May 5, 2016—(US) Notice of Allowance—U.S. Appl. No. 29/530,108, filed Jun. 12, 2015; Inv: Christopher Kujawski.
 May 2, 2016—(US) Notice of Allowance—U.S. Appl. No. 29/530,122, filed Jun. 12, 2015; Inv: Christopher Kujawski.
 Apr. 26, 2016—(US) Notice of Allowance—U.S. Appl. No. 29/530,111, filed Jun. 12, 2015; Inv: Christopher Kujawski.

(56)

References Cited

OTHER PUBLICATIONS

- Apr. 11, 2016—(US) Notice of Allowance—U.S. Appl. No. 29/530,113, filed Jun. 12, 2015; Inv: Christopher Kujawski.
- Apr. 14, 2016—(US) Non-Final Office Action—U.S. Appl. No. 29/530,114, filed Jun. 12, 2015; Inv: Christopher Kujawski.
- Apr. 11, 2016—(US) Notice of Allowance—U.S. Appl. No. 29/530,115, filed Jun. 12, 2015; Inv: Christopher Kujawski.
- May 6, 2016—(US) Notice of Allowance—U.S. Appl. No. 29/530,116, filed Jun. 12, 2015; Inv: Christopher Kujawski.
- May 2, 2016—(US) Notice of Allowance—U.S. Appl. No. 29/530,120, filed Jun. 12, 2015; Inv: Christopher Kujawski.
- May 6, 2016—(US) Notice of Allowance—U.S. Appl. No. 29/530,285, filed Jun. 15, 2015; Inv: Christopher Kujawski.
- Jun. 22, 2016—(US) Notice of Allowance—U.S. Appl. No. 29/530,243, filed Jun. 12, 2015; Inv: Christopher Kujawski.
- Apr. 26, 2016—(US) Non-Final Office Action—U.S. Appl. No. 29/530,237, filed Jun. 15, 2015; Inv: Christopher Kujawski.
- Jul. 27, 2016—(IN) Office Action—App 282967; filed Apr. 28, 2016; Inv: Christopher Kujawski.
- Aug. 2, 2016—(IN) Office Action—App 282964; filed Apr. 28, 2016; Inv: Christopher Kujawski.
- Jul. 27, 2016—(IN) Office Action—App 282965; filed Apr. 28, 2016; Inv: Christopher Kujawski.
- Aug. 2, 2016—(IN) Office Action—App 282968; filed Apr. 28, 2016; Inv: Christopher Kujawski.
- Aug. 4, 2016—(VN) Office Action—App 282968; filed Apr. 27, 2016; Inv: Christopher Kujawski.
- Aug. 2, 2016—(IN) Office Action—App 282966; filed Apr. 28, 2016; Inv: Christopher Kujawski.
- Jul. 22, 2016—(US) Notice of Allowance—U.S. Appl. No. 29/530,098, filed Jun. 12, 2015; Inv: Christopher Kujawski.
- Jul. 22, 2016—(US) Notice of Allowance—U.S. Appl. No. 29/530,106, filed Jun. 12, 2015; Inv: Christopher Kujawski.
- Jul. 25, 2016—(US) Notice of Allowance—U.S. Appl. No. 29/530,112, filed Jun. 12, 2015; Inv: Christopher Kujawski.
- Aug. 1, 2016—(US) Notice of Allowance—U.S. Appl. No. 29/530,114, filed Jun. 12, 2015; Inv: Christopher Kujawski.
- Aug. 5, 2016—(US) Notice of Allowance—U.S. Appl. No. 29/530,237, filed Jun. 15, 2015; Inv: Christopher Kujawski.
- May 19, 2016—(KR) Office Action—App 30-2015-0063248; filed Dec. 11, 2015; Inv: Christopher Kujawski.
- Aug. 22, 2016—(KR) Office Action—App 30-2015-0063248; filed Dec. 11, 2015; Inv: Christopher Kujawski.
- Apr. 26, 2016—(JP) Office Action—App 2015-027786; filed Dec. 11, 2015; Inv: Christopher Kujawski.
- Aug. 23, 2016—(JP) Office Action—App 2015-027786; filed Dec. 11, 2015; Inv: Christopher Kujawski.
- Sep. 23, 2016—(US) Notice of Allowance—U.S. Appl. No. 29/543,968, filed Oct. 29, 2015; Inv.: Christopher Kujawski.
- May 21, 2016—(CA) Examiners Report—App 168250; filed Apr. 29, 2016; Inv: Christopher Kujawski.
- U.S. Appl. No. 29/530,098, filed Jun. 12, 2015.
- U.S. Appl. No. 29/530,106, filed Jun. 12, 2015.
- U.S. Appl. No. 29/530,225, filed Jun. 15, 2015.
- U.S. Appl. No. 29/530,102, filed Jun. 12, 2015.
- U.S. Appl. No. 29/530,110, filed Jun. 12, 2015.
- U.S. Appl. No. 29/530,122, filed Jun. 12, 2015.
- U.S. Appl. No. 29/530,108, filed Jun. 12, 2015.
- U.S. Appl. No. 29/530,111, filed Jun. 12, 2015.
- U.S. Appl. No. 29/530,112, filed Jun. 12, 2015.
- U.S. Appl. No. 29/530,113, filed Jun. 12, 2015.
- U.S. Appl. No. 29/530,114, filed Jun. 12, 2015.
- U.S. Appl. No. 29/530,115, filed Jun. 12, 2015.
- U.S. Appl. No. 29/530,116, filed Jun. 12, 2015.
- U.S. Appl. No. 29/530,120, filed Jun. 12, 2015.
- U.S. Appl. No. 29/530,285, filed Jun. 15, 2015.
- U.S. Appl. No. 29/530,243, filed Jun. 15, 2015.
- U.S. Appl. No. 29/530,237, filed Jun. 15, 2015.
- U.S. Appl. No. 29/543,963, filed Oct. 29, 2015.
- U.S. Appl. No. 29/543,976, filed Oct. 29, 2015.
- U.S. Appl. No. 29/543,902, filed Oct. 29, 2015.
- U.S. Appl. No. 29/543,904, filed Oct. 29, 2015.
- U.S. Appl. No. 29/543,910, filed Oct. 29, 2015.
- U.S. Appl. No. 29/543,914, filed Oct. 29, 2015.
- U.S. Appl. No. 29/543,958, filed Oct. 29, 2015.
- U.S. Appl. No. 29/543,931, filed Oct. 29, 2015.
- U.S. Appl. No. 29/543,968, filed Oct. 29, 2015.
- Sep. 29, 2016—(TW) Notice of Allowance—App 105302369.
- Sep. 26, 2016—(TW) Search Report—App 105302369.
- Sep. 22, 2016—(TW) Search Report—App 105302366—Eng Tran.
- Sep. 26, 2016—(TW) Notice of Allowance—App 105302366.
- Sep. 29, 2016—(TW) Notice of Allowance—App 105302361.
- Sep. 22, 2016—(TW) Search Report—App 105302361—Eng Tran.
- Sep. 29, 2016—(TW) Notice of Allowance—App 105302367.
- Sep. 22, 2016—(TW) Search Report—App 105302367—Eng Tran.
- Nov. 30, 2016—(US) Non-Final Office Action—U.S. Appl. No. 29/543,976, filed Oct. 29, 2015; Inv: Christopher Kujawski.
- Dec. 6, 2016—(US) Notice of Allowance—U.S. Appl. No. 29/543,958, filed Jan. 29, 2015; Inv.: Christopher Kujawski.
- Nov. 28, 2016—(US) Notice of Allowance—U.S. Appl. No. 29/543,931, filed Jan. 29, 2015; Inv.: Christopher Kujawski.
- Sep. 19, 2016—(TW) Notice of Allowance—App 104306953D01.
- Sep. 9, 2016—(TW) Search Report—App 104306953D01—Eng Tran.
- Sep. 22, 2016—(TW) Search Report—App 105302371.
- Nov. 16, 2016—(TW) Search Report—App 105302368—Eng Tran.
- Nov. 15, 2016—(TW) Notice of Allowance—App 105302362.
- Sep. 29, 2016—(TW) Notice of Allowance—App 105302370.
- Dec. 12, 2016—U.S. Notice of Allowance—U.S. Appl. No. 29/543,963, filed Oct. 29, 2015; Inv.: Christopher Kujawski.
- Nov. 7, 2016—(TW) Search Report—App 105302362.
- Sep. 22, 2016—(TW) Search Report—App 105302370.
- Dec. 14, 2016—U.S. Notice of Allowance—U.S. Appl. No. 29/543,898, filed Oct. 29, 2015; Inv.: Christopher Kujawski.
- Dec. 14, 2016—U.S. Notice of Allowance—U.S. Appl. No. 29/543,902, filed Oct. 29, 2015; Inv.: Christopher Kujawski.
- Dec. 12, 2016—U.S. Notice of Allowance—U.S. Appl. No. 29/543,914, filed Oct. 26, 2015; Inv.: Christopher Kujawski.
- Sep. 29, 2016—(TW) Notice of Allowance—App 105302371.
- Dec. 20, 2016—U.S. Notice of Allowance—U.S. Appl. No. 29/543,904, filed Oct. 29, 2015; Inv.: Christopher Kujawski.

* cited by examiner

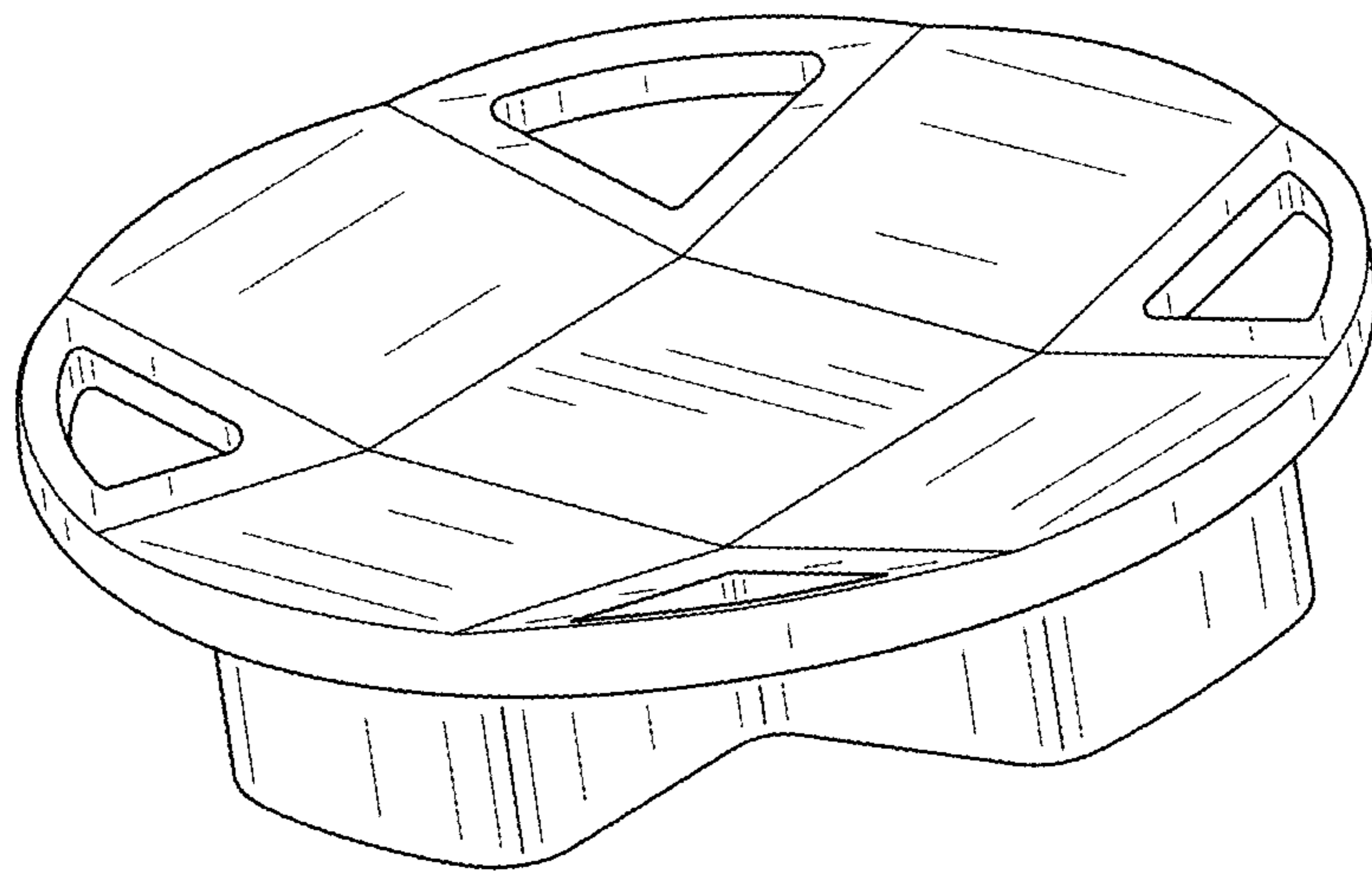

FIG. 1

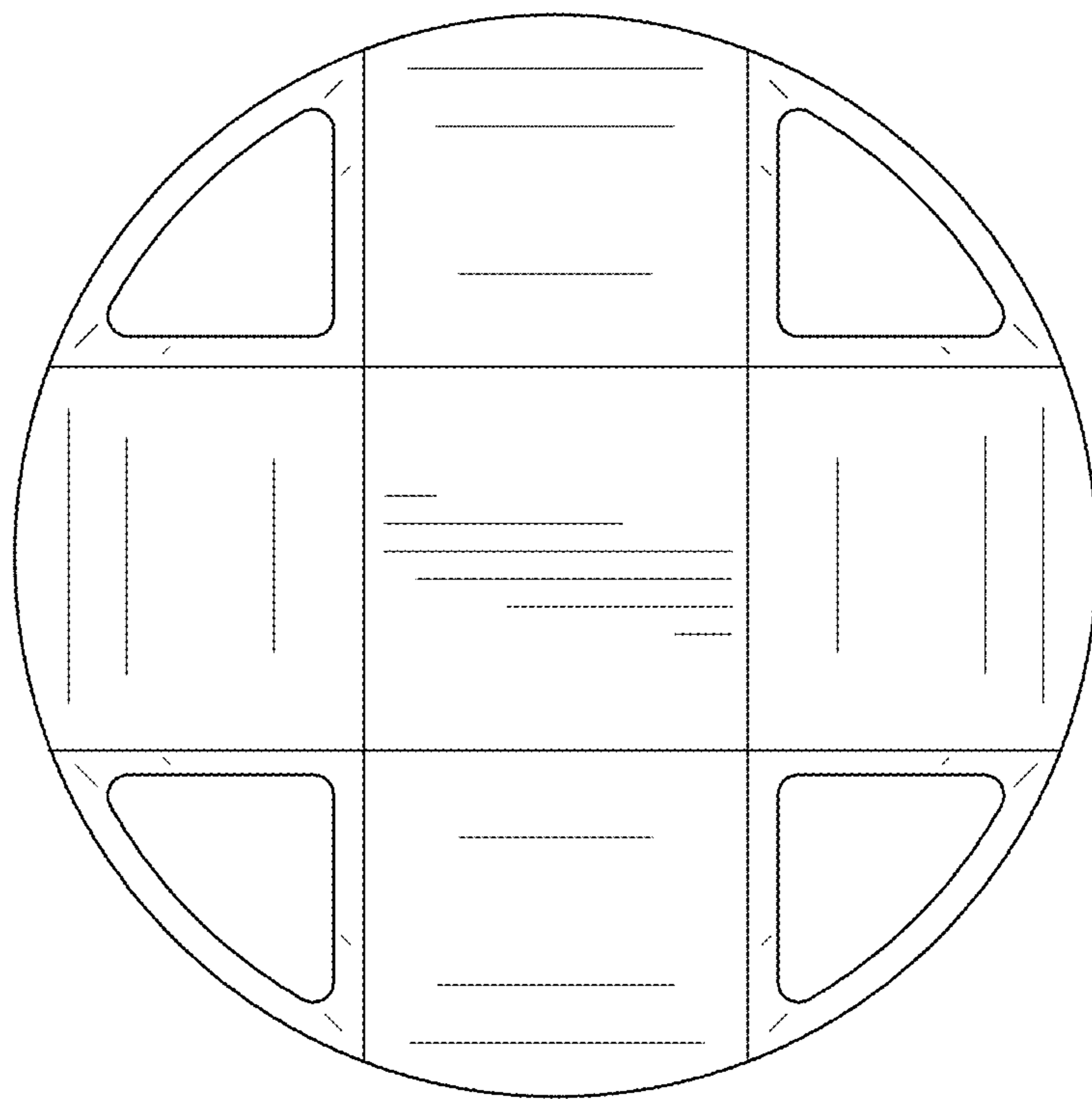

FIG. 2

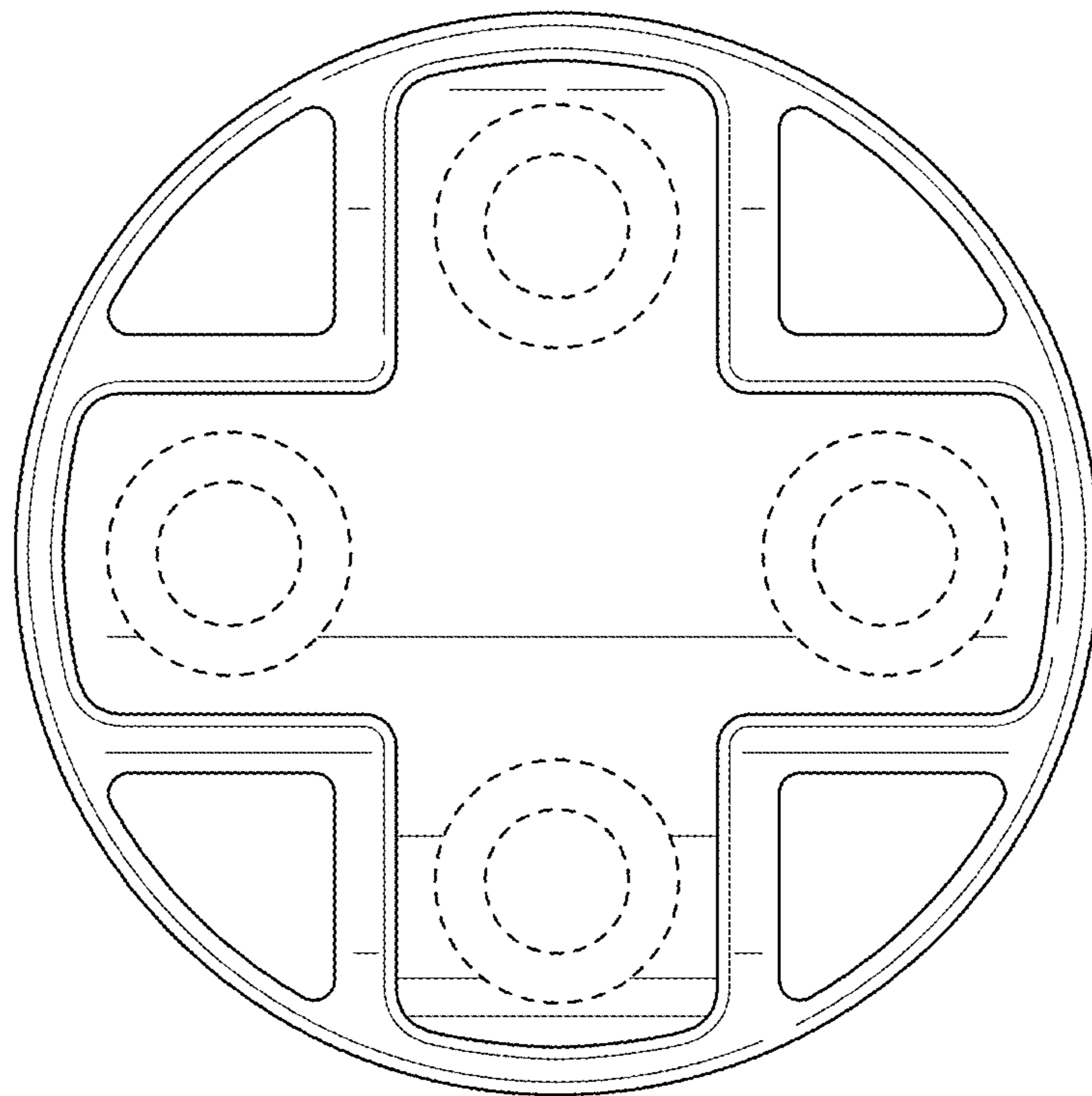

FIG. 3

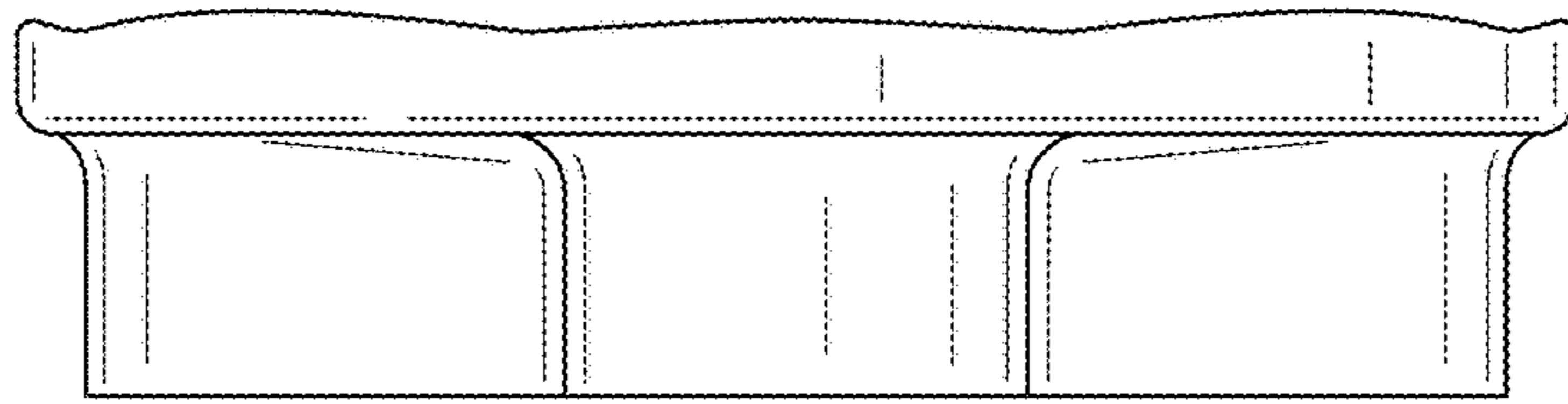

FIG. 4

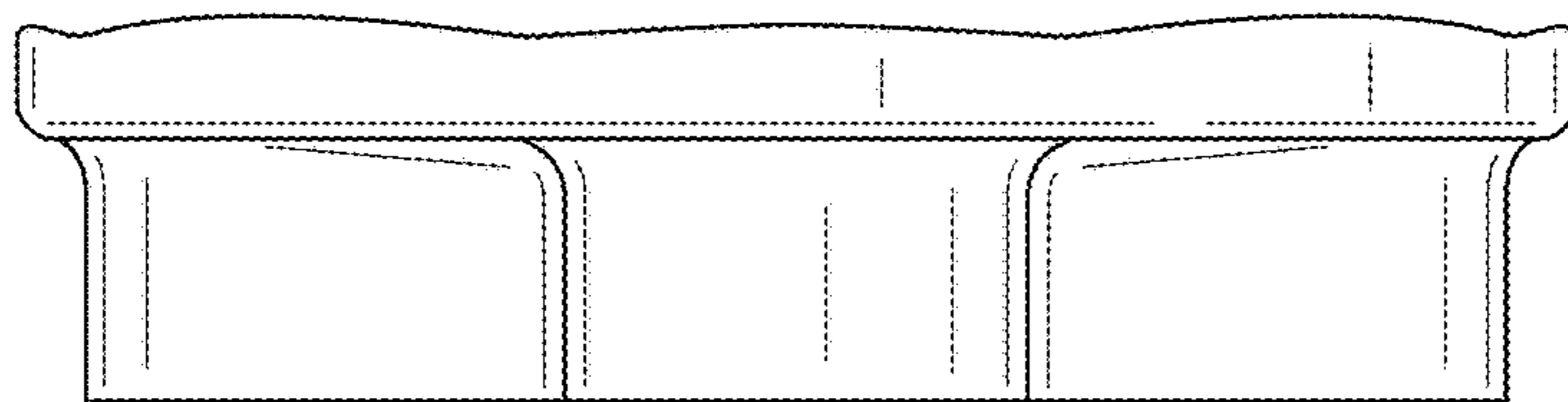

FIG. 5

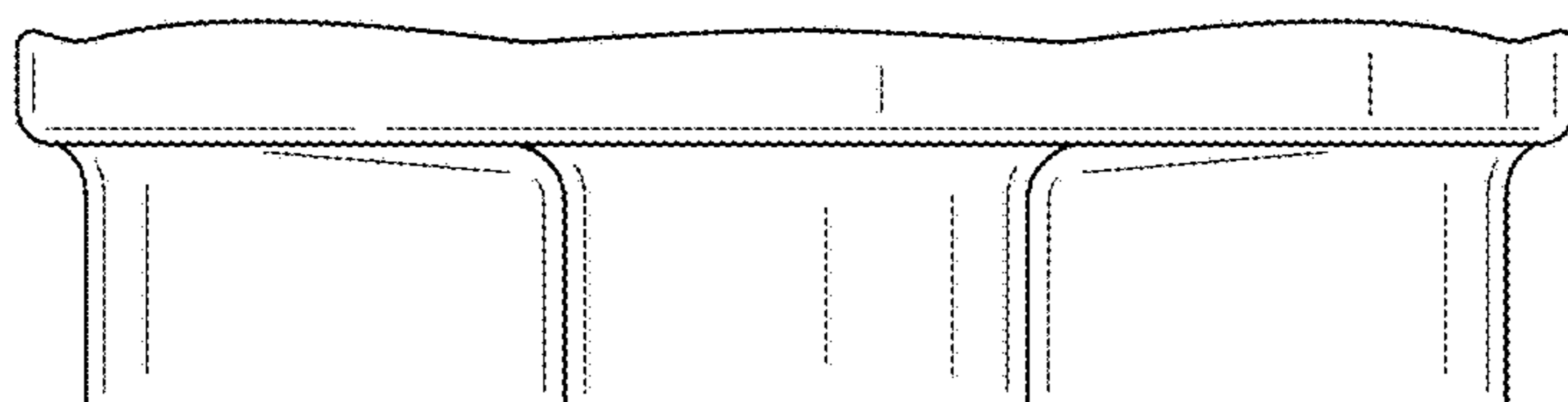

FIG. 6

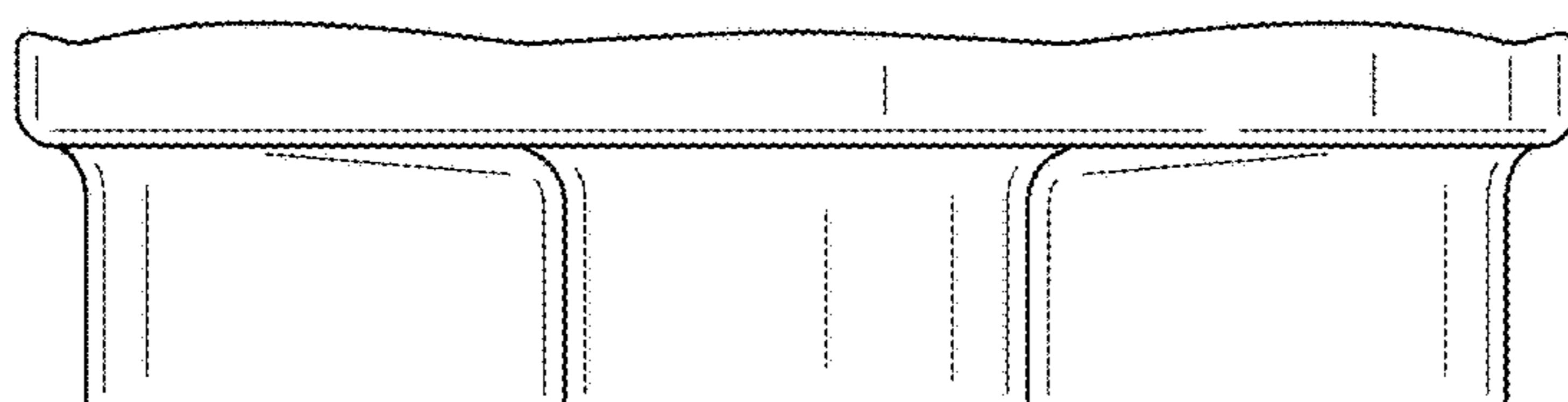

FIG. 7

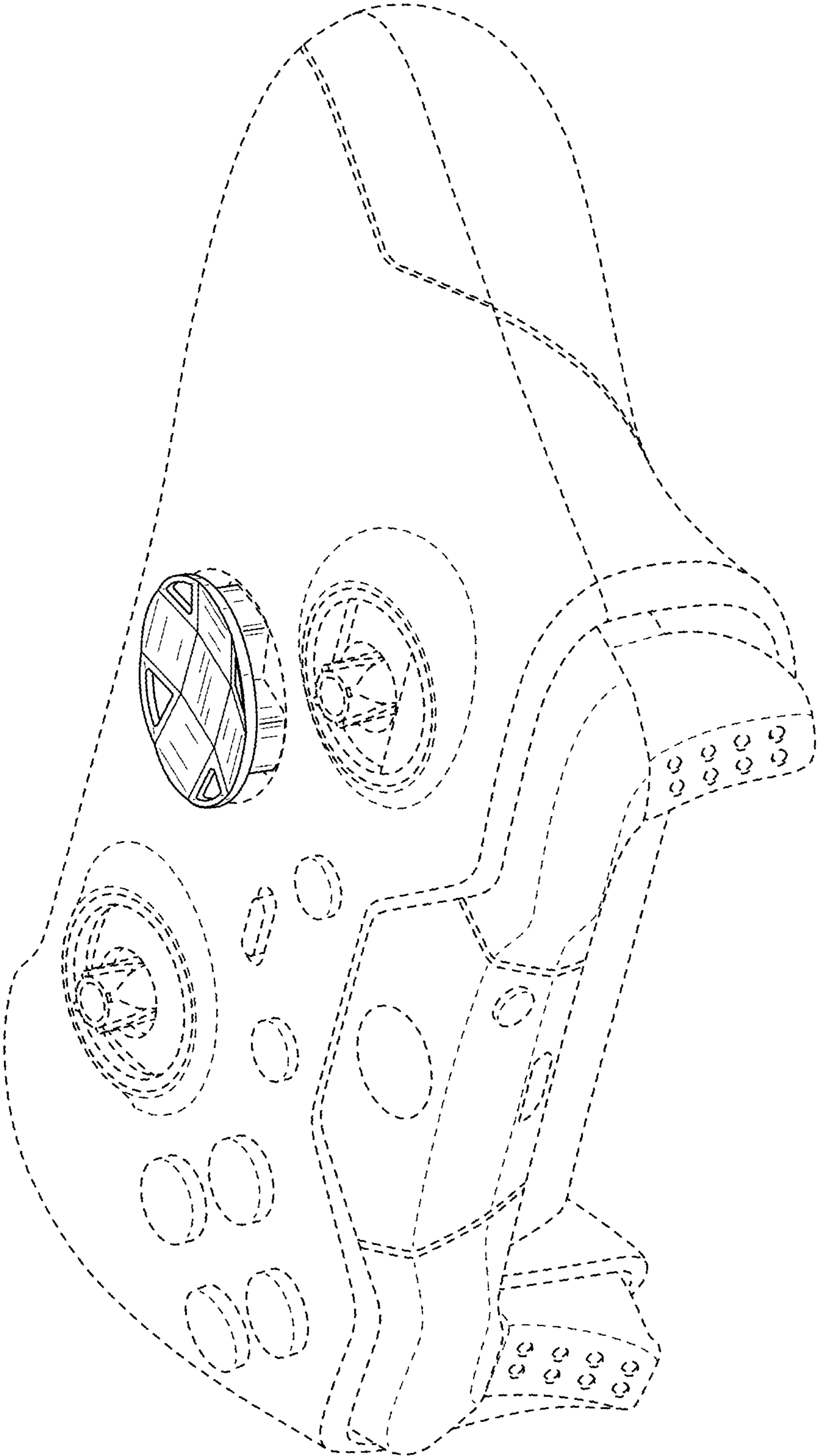

FIG. 8

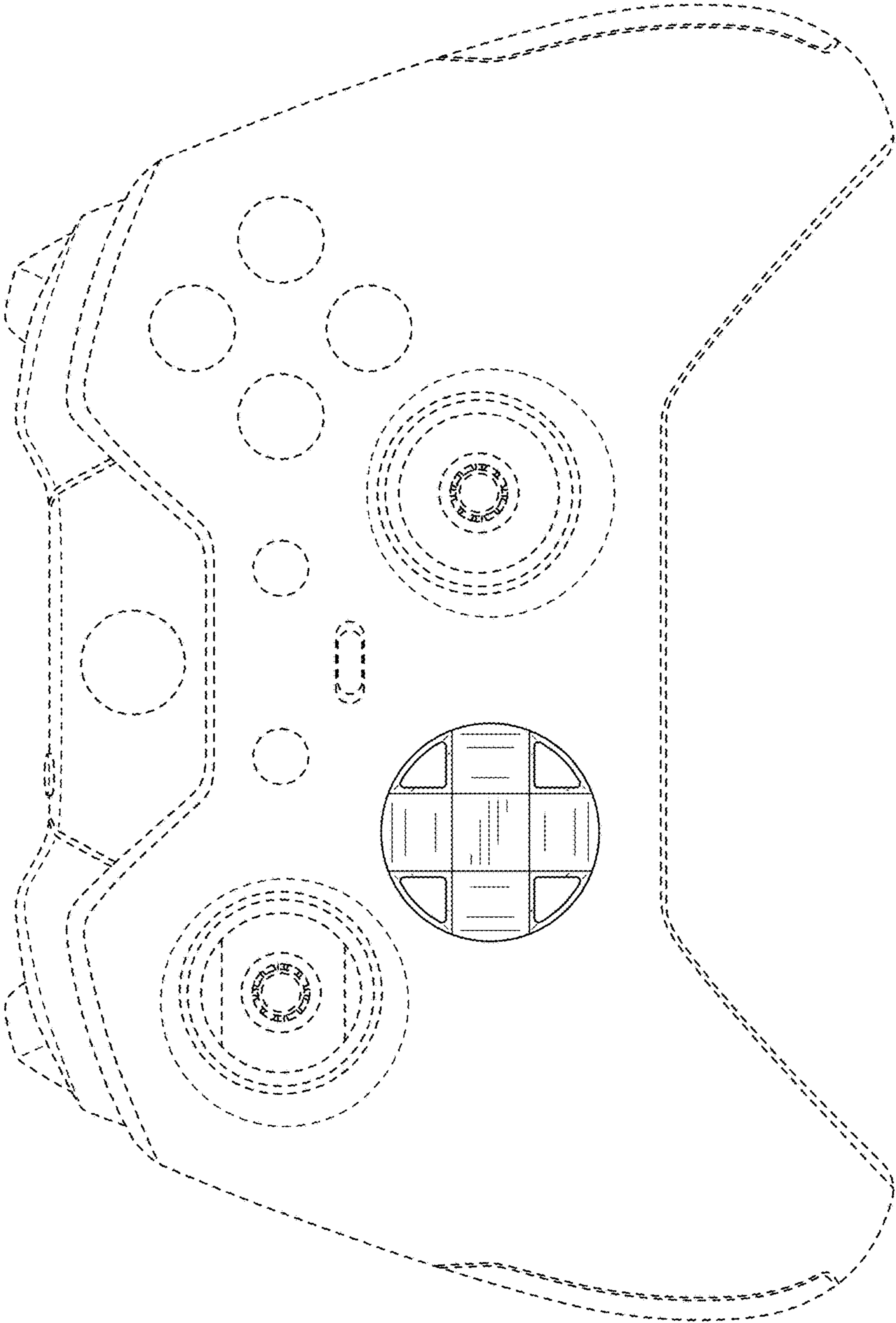

FIG. 9

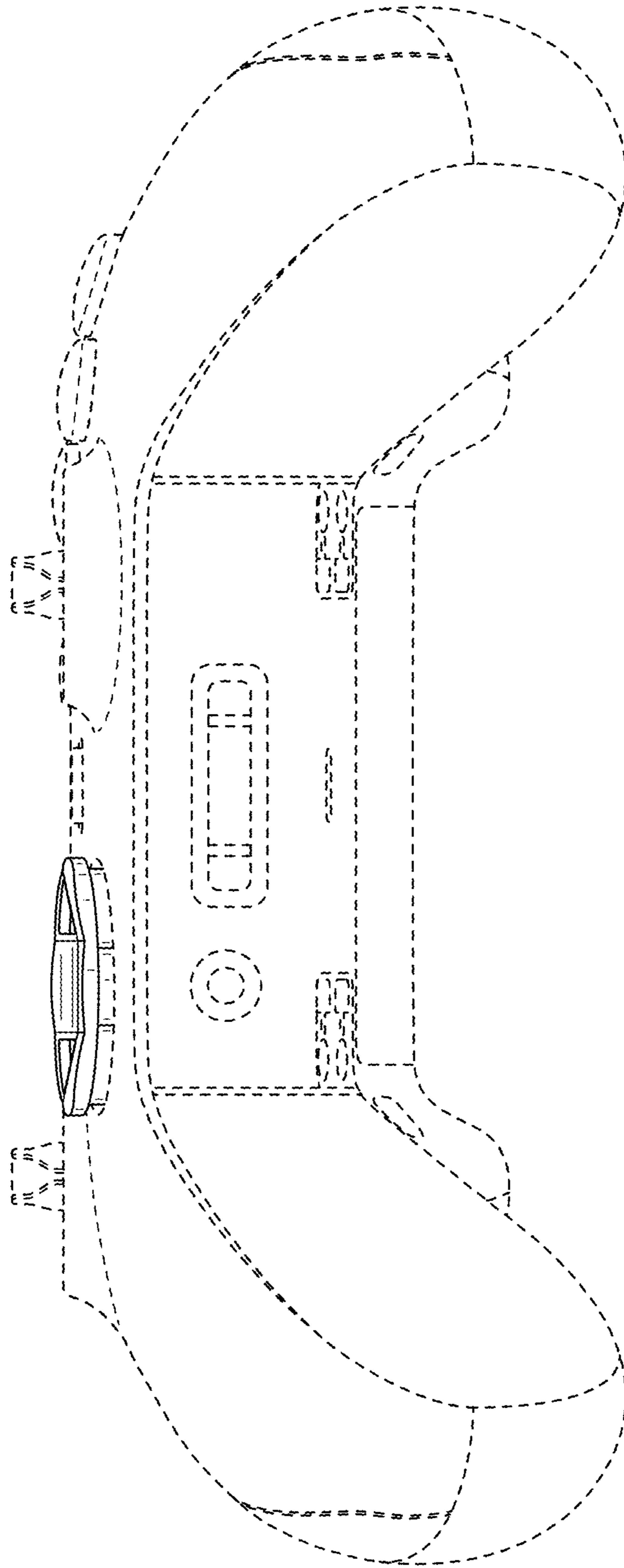

FIG. 10

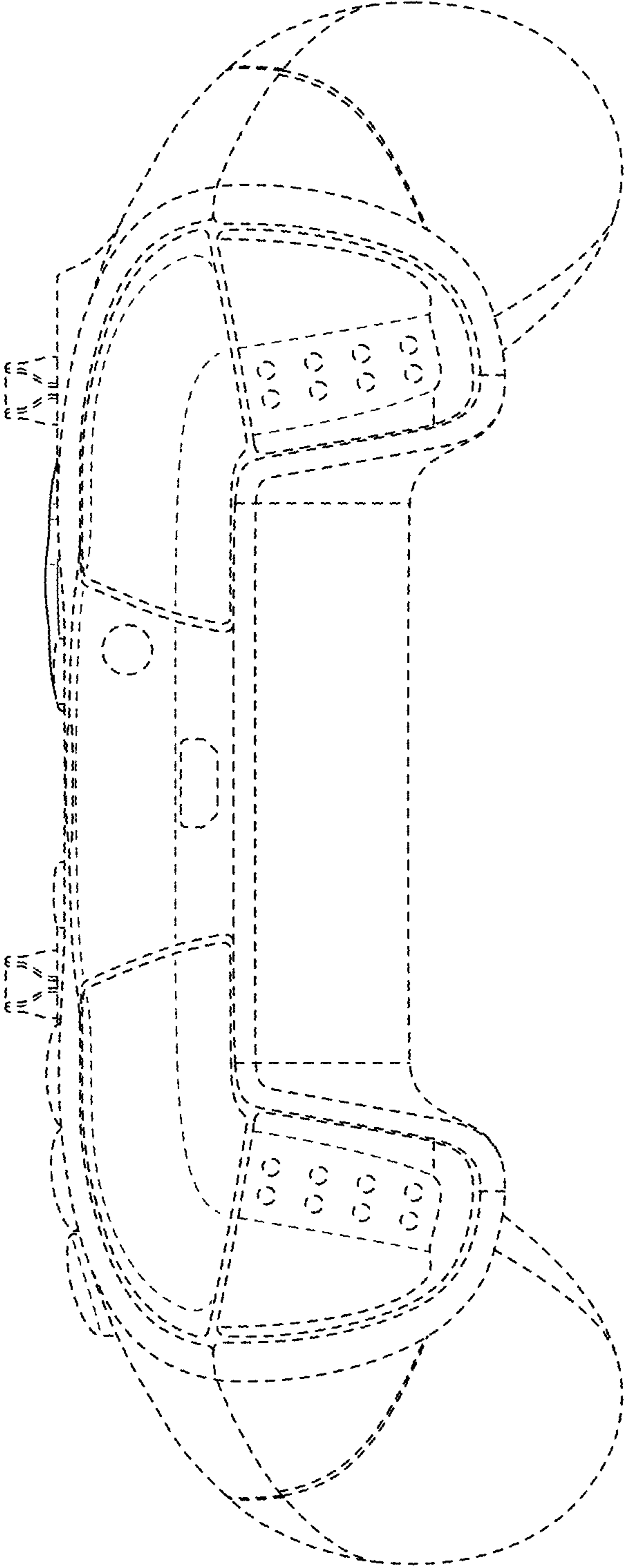

FIG. 11

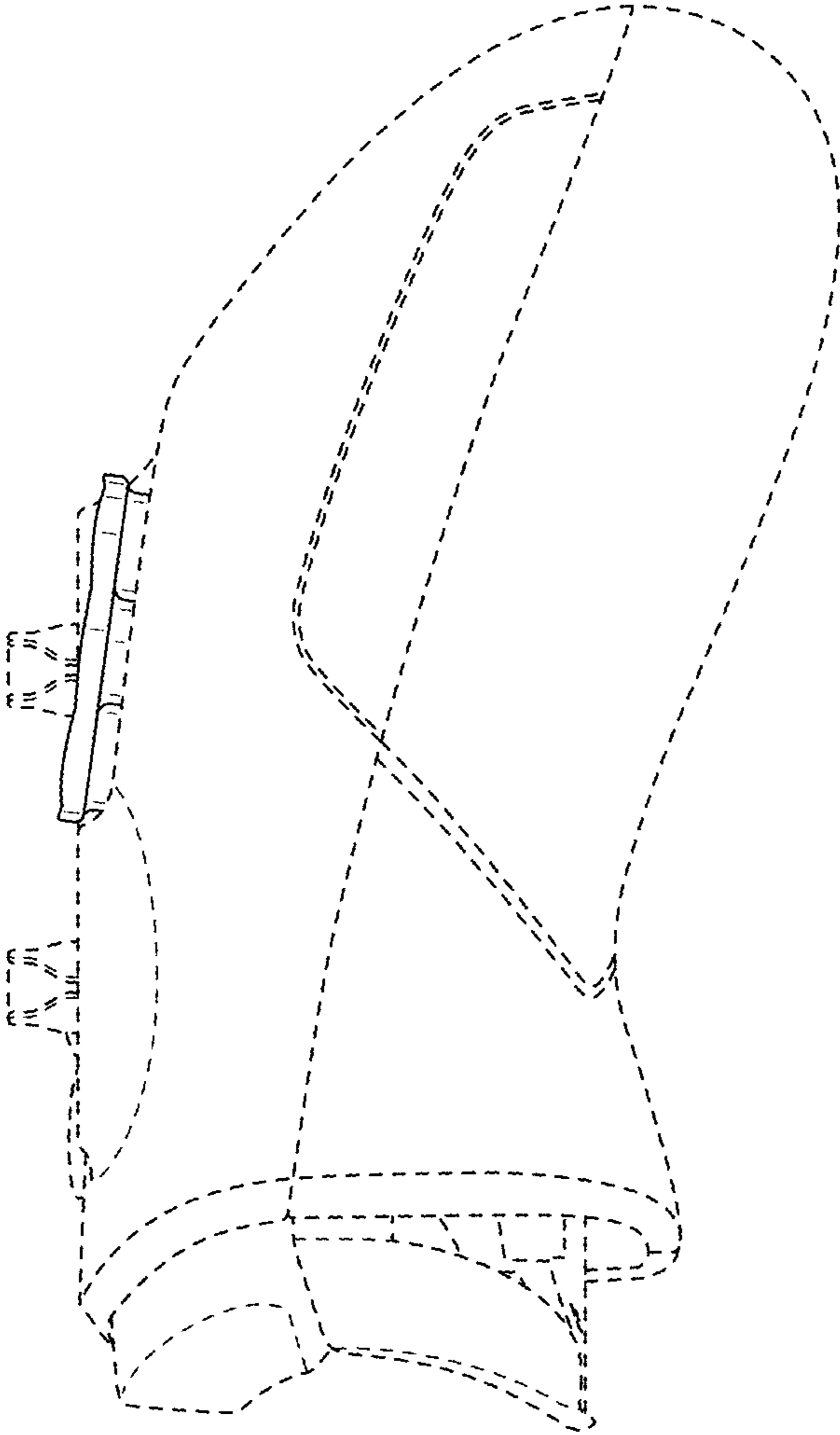

FIG. 12

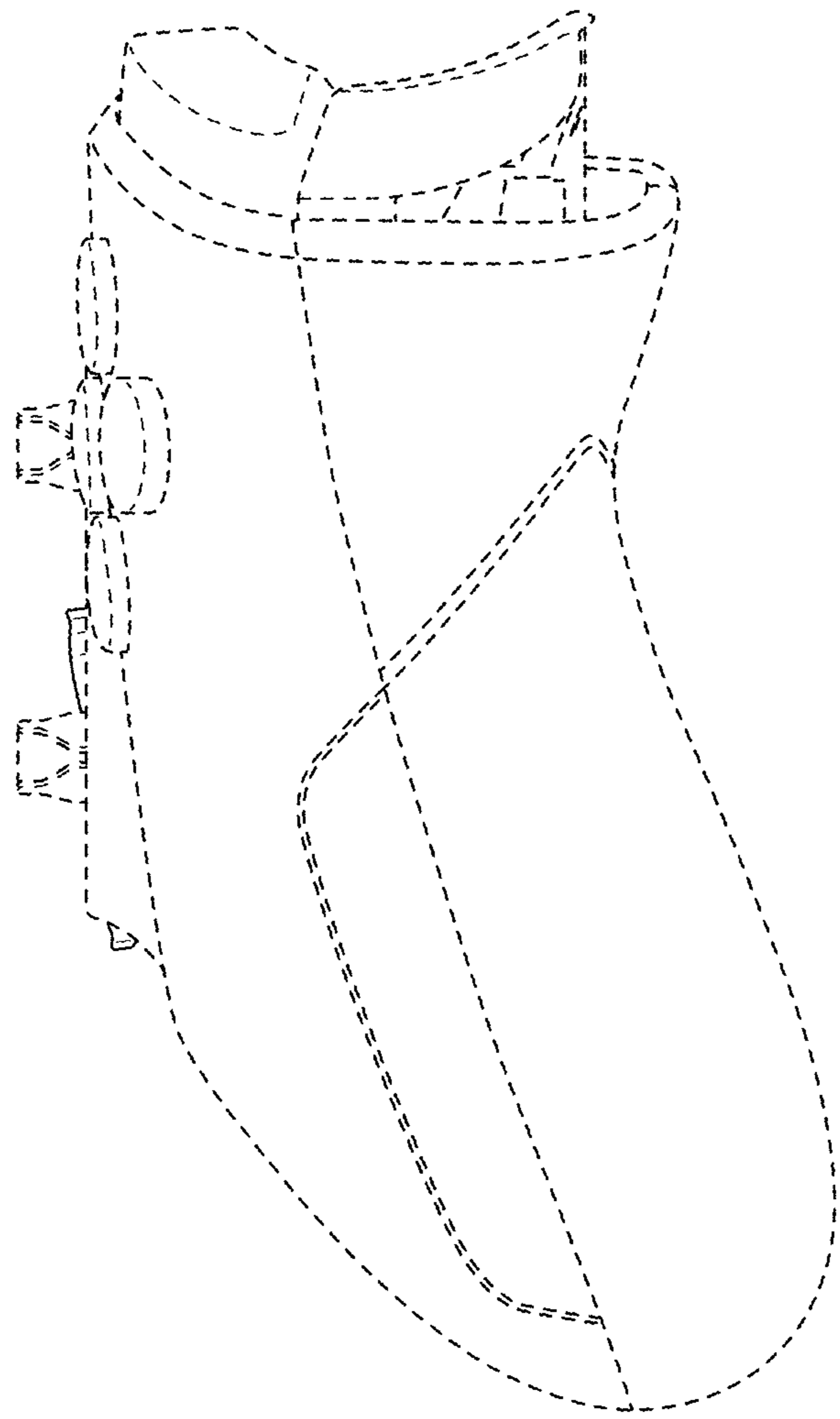

FIG. 13