

US00D793947S

(12) **United States Design Patent** (10) **Patent No.:** **US D793,947 S**
Badillo (45) **Date of Patent:** **** Aug. 8, 2017**

(54) **VEHICLE RACK**
(71) Applicant: **Intelligent Designs 2000 Corp.**,
Aurora, CO (US)
(72) Inventor: **Paul Badillo**, Littleton, CO (US)
(73) Assignee: **INTELLIGENT DESIGNS 2000**
CORP., Aurora, CO (US)
(**) Term: **15 Years**
(21) Appl. No.: **29/547,752**
(22) Filed: **Dec. 7, 2015**
(51) **LOC (10) Cl.** **12-16**
(52) **U.S. Cl.**
USPC **D12/412**
(58) **Field of Classification Search**
USPC D12/412, 406, 413, 414, 414.1; D6/552;
D3/304-306
CPC B60R 9/00; B60R 9/02; B60R 9/04; B60R
9/08; B60R 9/055; B60R 9/058; B60R
9/06; B60R 9/065; B60R 9/10; B60R
9/12
See application file for complete search history.

3,260,929 A 7/1966 Hedgepeth
3,330,454 A 7/1967 Bott
3,531,006 A 9/1970 Farchmin
3,765,713 A 10/1973 Suitt
3,902,642 A 9/1975 McNeece
4,336,897 A 6/1982 Luck
4,350,471 A 9/1982 Lehmann
4,817,834 A 4/1989 Weiler
4,948,024 A 8/1990 Warner et al.
5,171,083 A 12/1992 Rich
5,381,939 A 1/1995 Tippets
D359,134 S 6/1995 Toews
5,560,525 A 10/1996 Grohmann et al.
D406,557 S 3/1999 Bentley
D413,562 S 9/1999 Van Dusen et al.
(Continued)

OTHER PUBLICATIONS

U.S. Appl. No. 29/534,977, filed Aug. 3, 2015, Badillo.
(Continued)

Primary Examiner — Katrina A Betton
(74) *Attorney, Agent, or Firm* — Sheridan Ross PC

(57) **CLAIM**

The ornamental design for a vehicle rack, as shown and described.

DESCRIPTION

FIG. 1 is a perspective view of a vehicle rack;
FIG. 2 is a front elevation view thereof;
FIG. 3 is a rear elevation view thereof;
FIG. 4 is a right elevation view thereof;
FIG. 5 is a left elevation view thereof;
FIG. 6 is a top plan view thereof;
FIG. 7 is a bottom plan view thereof; and,
FIG. 8 is a perspective view thereof interconnected to a sport utility vehicle.
The broken lines depict unclaimed environmental subject matter and do not form any part of the claimed design.

1 Claim, 6 Drawing Sheets

(56) **References Cited**
U.S. PATENT DOCUMENTS
704,436 A 7/1902 Cluff
744,113 A 11/1903 Rye
1,564,776 A 12/1925 Green
1,606,954 A 11/1926 Moen et al.
2,387,779 A 10/1945 Strauss
2,492,841 A 12/1949 Burkey
2,521,815 A 9/1950 Will
2,663,472 A 12/1953 Belgau
2,784,888 A 3/1957 Lecanu-Deschamps
2,800,264 A 7/1957 McFadyen
2,967,635 A 1/1961 Barnett
3,158,301 A 11/1964 Hedgepeth
3,215,323 A 11/1965 Bonitt

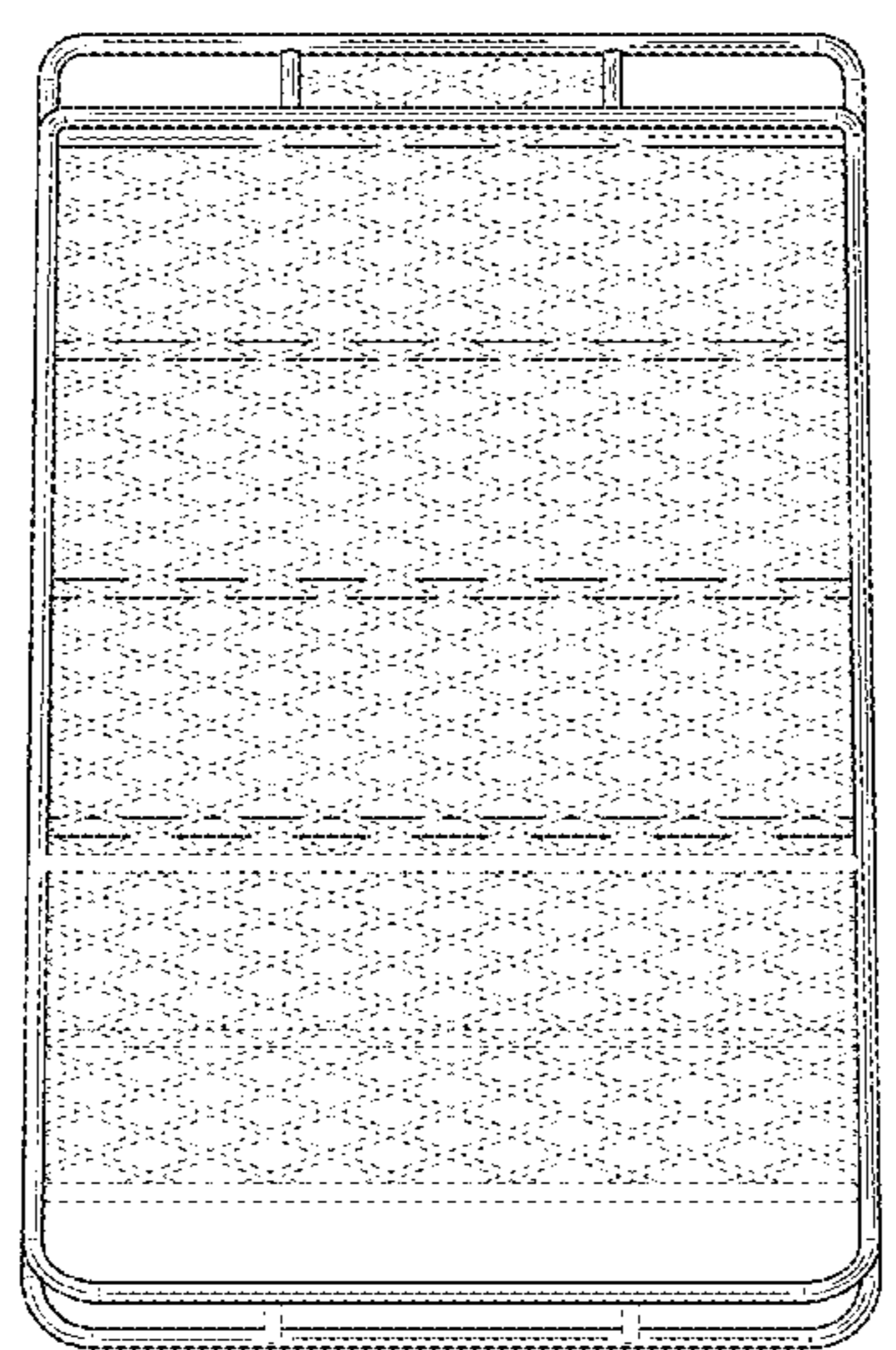

(56)

References Cited

U.S. PATENT DOCUMENTS

6,003,633	A	12/1999	Rolson	
6,015,074	A	1/2000	Snavely et al.	
D422,553	S	4/2000	VonDuyke	
6,116,378	A	9/2000	Barrow	
D434,364	S	11/2000	Bauer et al.	
6,152,339	A	11/2000	Kreisler	
D434,718	S	12/2000	Kreisler	
D435,510	S	12/2000	Quidort	
6,179,180	B1	1/2001	Walker et al.	
D442,289	S	5/2001	Ziaylek et al.	
6,425,508	B1	7/2002	Cole et al.	
D463,358	S *	9/2002	Thomas	D12/406
D470,451	S	2/2003	Bushart et al.	
6,561,397	B1	5/2003	Bove et al.	
6,581,813	B2	6/2003	Bove et al.	
D477,562	S *	7/2003	McCoy	D12/406
6,604,606	B1	8/2003	McDougal et al.	
D479,884	S	9/2003	Berryman	
D481,003	S	10/2003	Bauer et al.	
D490,163	S	5/2004	Thurston	
6,739,349	B2	5/2004	Kastenschmidt et al.	
6,755,332	B2	6/2004	Crane et al.	
D508,015	S	8/2005	Badillo	
D512,783	S	12/2005	Badillo	
D520,938	S	5/2006	Badillo	
7,055,454	B1	6/2006	Whiting et al.	
D537,404	S	2/2007	Bauer et al.	
7,226,266	B2	6/2007	Henderson et al.	
7,249,927	B2	7/2007	Wooten et al.	
D549,838	S	8/2007	Badillo	
D558,123	S	12/2007	Murillo	
D578,952	S	10/2008	Badillo	
D603,321	S *	11/2009	Kramer	D12/412
D621,328	S *	8/2010	Sistare	D12/222
D624,005	S *	9/2010	Winner	D12/412
D638,333	S *	5/2011	Freeman	D12/412
8,496,146	B2	7/2013	Badillo	
D765,577	S *	9/2016	Kmita	D12/412
D772,783	S *	11/2016	Schleef	D12/412
2005/0082326	A1	4/2005	Badillo	
2005/0092796	A1	5/2005	Essig	
2005/0095102	A1	5/2005	Watson	
2011/0101056	A1	5/2011	Barkey	
2013/0299538	A1	11/2013	Badillo	

OTHER PUBLICATIONS

U.S. Appl. No. 29/535,865, filed Aug. 11, 2015, Badillo.
 U.S. Appl. No. 29/535,957, filed Aug. 12, 2015, Badillo.
 U.S. Appl. No. 29/542,039, filed Oct. 9, 2015, Badillo.

U.S. Appl. No. 29/543,871, filed Oct. 29, 2015, Badillo.
 Advertisement: Yakima Spare Tire Carrier, Cargo Basket for Roof Racks, available at http://www.rackoutfitters.com/catalog/yakima_spare_tire_carrier_1836640.htm, dated Jul. 7, 2003, 1 page.
 Advertisement: Thule 840—Playpen Basket, Cargo Basket for Roof Racks, available at http://www.rackoutfitters.com/catalog/thule_840_-_playpen_basket_1885452.htm, dated Jul. 7, 2003, 1 page.
 Advertisement: SURCO, Products, Inc., “Basket Rack-it just flat out carries what you need to take,” available at http://www.everythingsuv.com/surco_safari_roof_racks-esuv.asp, dated Jul. 7, 2003, 10 pages.
 Advertisement: KargoMaster, Kargo Master Safari Racks, available at http://www.kargomaster.com/jeep23.asp?rack=sport_jeep, Jul. 7, 2007, 1 page.
 Advertisement: KargoMaster, The Bushman Steel Rack, available at <http://www.kargomaster.com/bushman.asp?type=Jeep>, dated Jul. 7, 2003, 1 page.
 Advertisement: KargoMaster, Seregenti Telescoping Steel Rack, available at <http://www.kargomaster.com/seregenti.asp?type=Jeep>, dated Jul. 7, 2003, 1 page.
 Advertisement: Bauer Vehicle Gear Roof Racks, Roof Storage, Bike Storage & Pet Barriers from Eve, available at http://www.everythingsuv.com/bvg_products-esuv.asp, Jul. 7, 2003, 2 pages.
 Advertisement: Manik Original Off-Road Equipment, Hummer Rough Terrain Package New Product Release “Tilt-Forward 1-Piece Front Bar,” 2002, 1 page.
 Advertisement: Manik Original Off-Road Equipment, Hummer Rough Terrain Package New Product Release “Combination Tube Step Rocker Bar,” 2002, 1 page.
 Advertisement: Congo Cage Jeep Rack, available at <http://www.kargomaster.com/item.asp?id=62>, printed Apr. 17, 2009, 13 pages.
 Product Literature entitled, “921—Dave’s Rack 921-12X,” Olympic 4X4, date unknown, 10 pages.
 Advertisement: 921—Daves Rack, Olympic 4X4 Products for over 60 years, available at <http://olympic4x4products.com/utility-racks/921-daves-rack>, printed Jan. 14, 2011, 3 pages.
 “Installation Guide: BR-JPTJ2D-1-0 BajaRack Jeep TJ 2 Doors,” BajaRack Adventure Equipment, 4 page, first sold 2013.
 “BR-JPJK-Series Installation Instructions,” BajaRack Adventure Equipment, 5 pages, first sold 2013.
 “Full Length 4th Gen Rack,” Whitson Metalworks, 2015, retrieved from <http://web.archive.org/web/20150704141048/http://whitsonmetalworks.com/product/full-length-4th-gen-rack/>, retrieved on Dec. 10, 2015, 5 pages.
 “ID2 Racks,” Intelligent Designs 2000 Corp., www.GOBlracks.com; it is believed that all have been sold for over one year, 27 pages.
 “Installation Guide: BR-JP-JK4D-1-0 BajaRack Jeep JK 4 Doors,” BajaRack Adventure Equipment, 6 pages, first sold 2013.

* cited by examiner

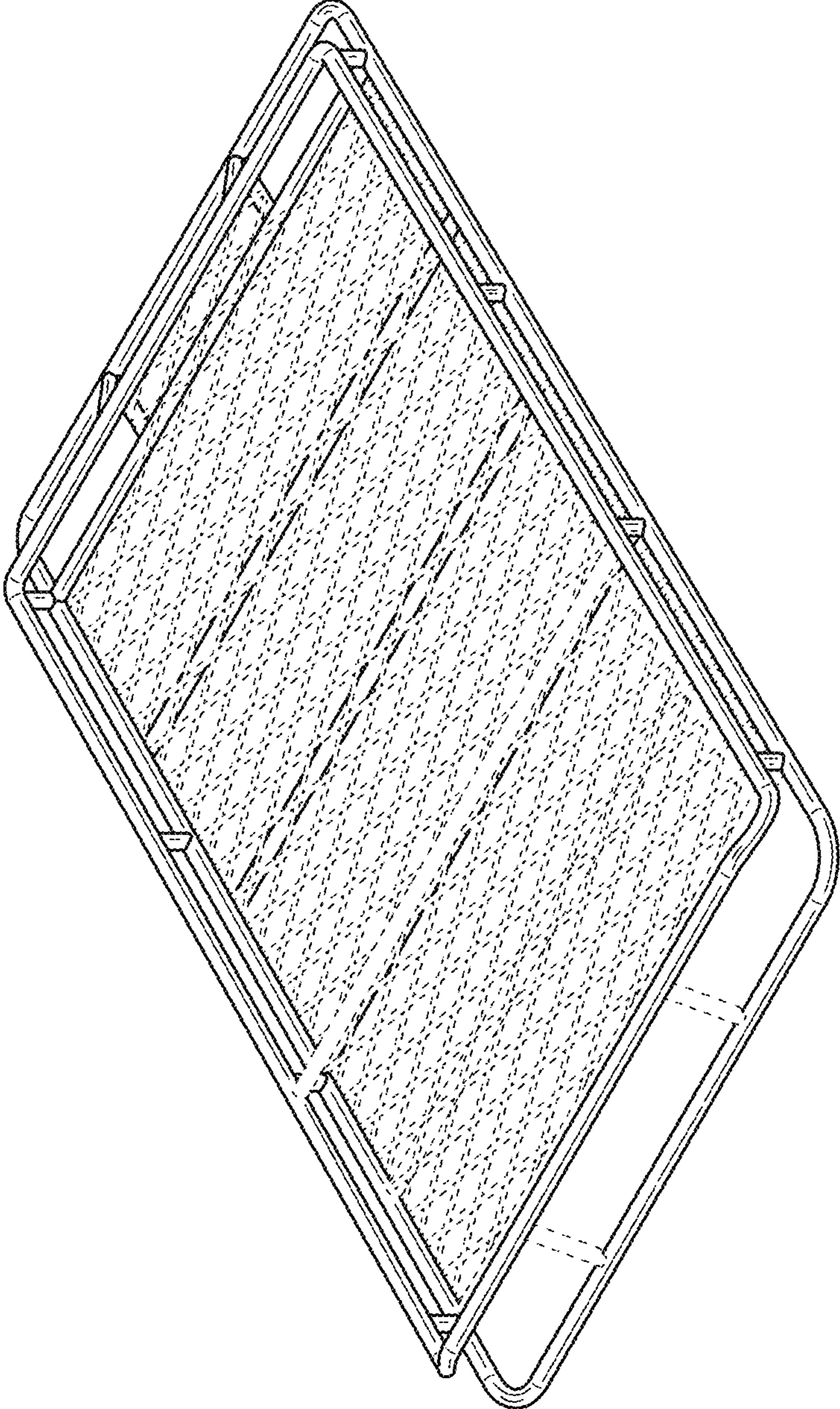

FIG.1

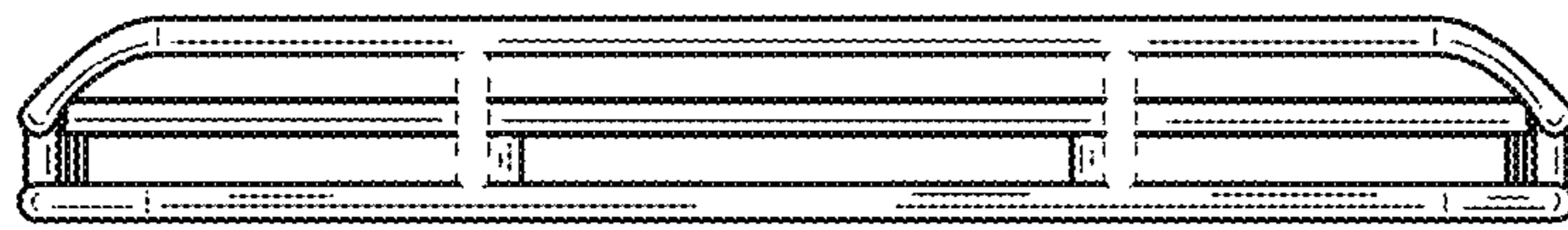

FIG. 2



FIG. 3

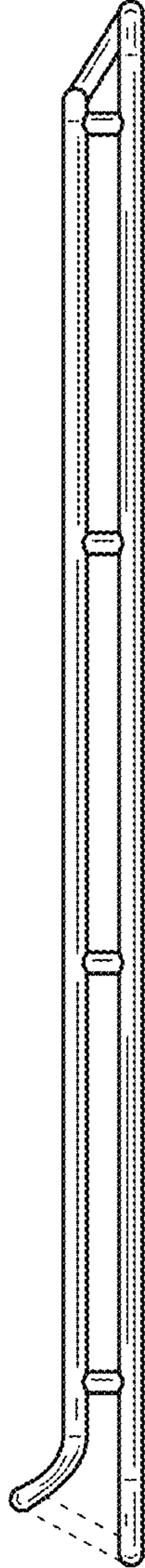

FIG. 4



FIG. 5

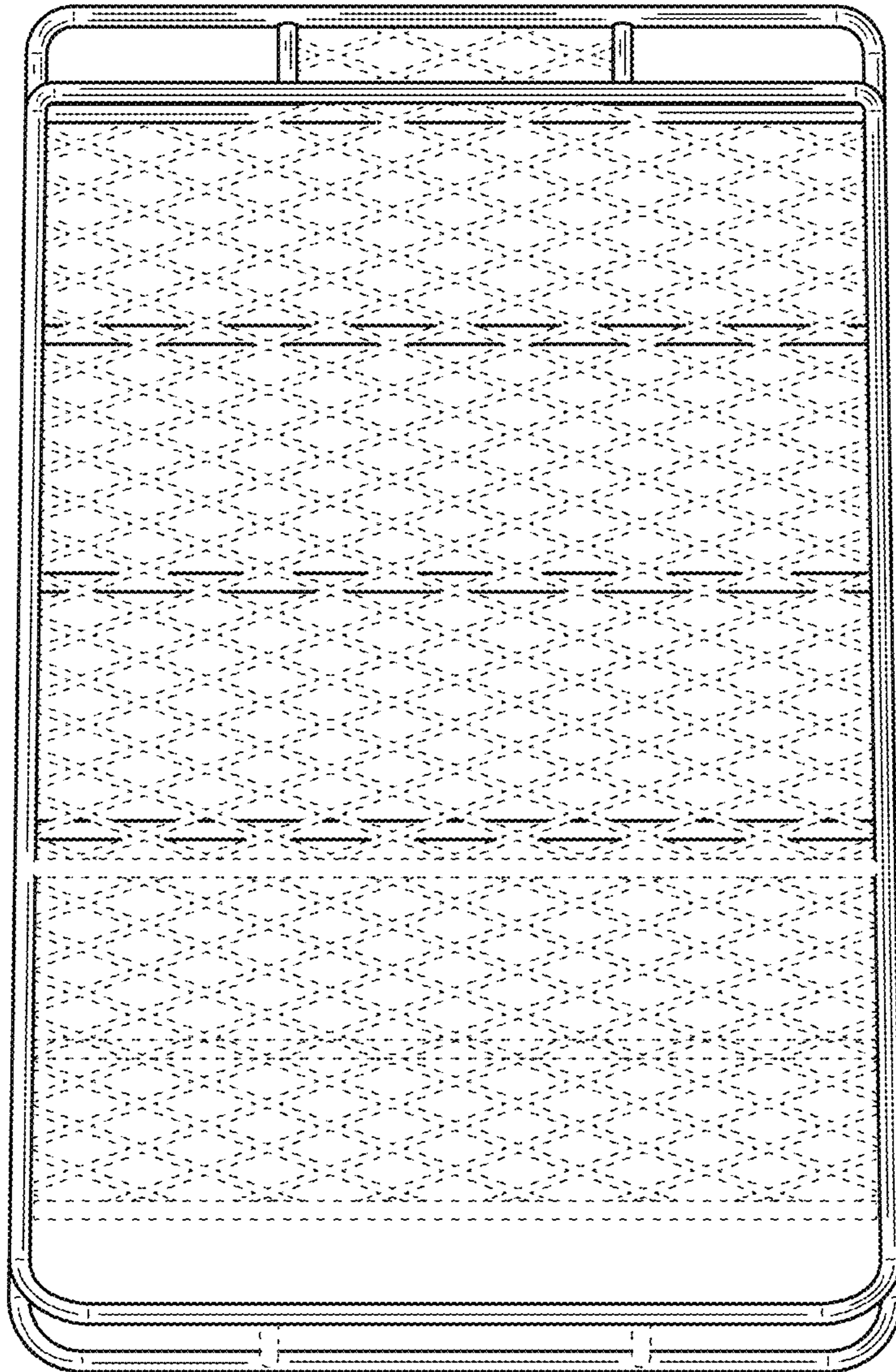

FIG.6

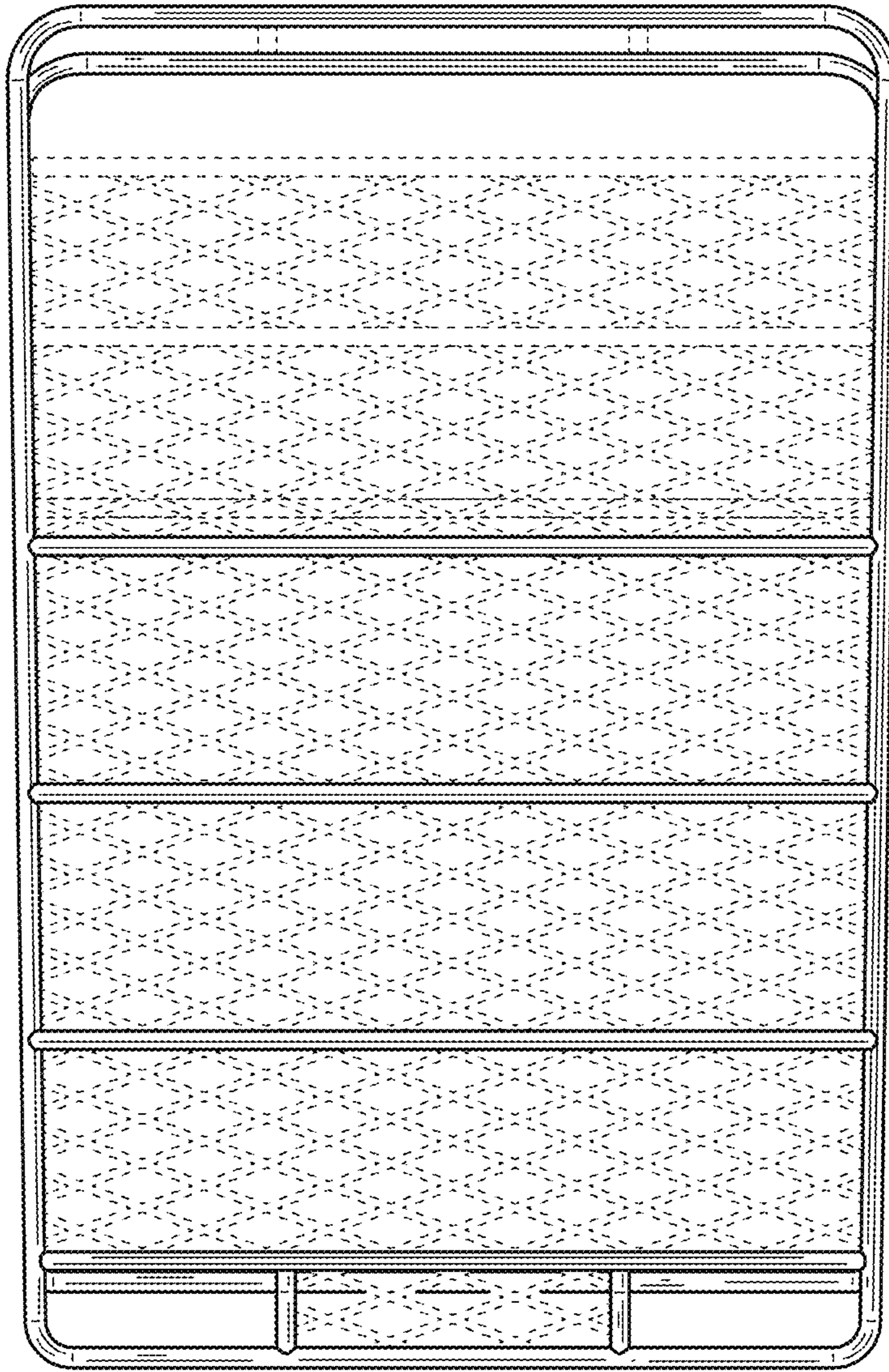

FIG.7

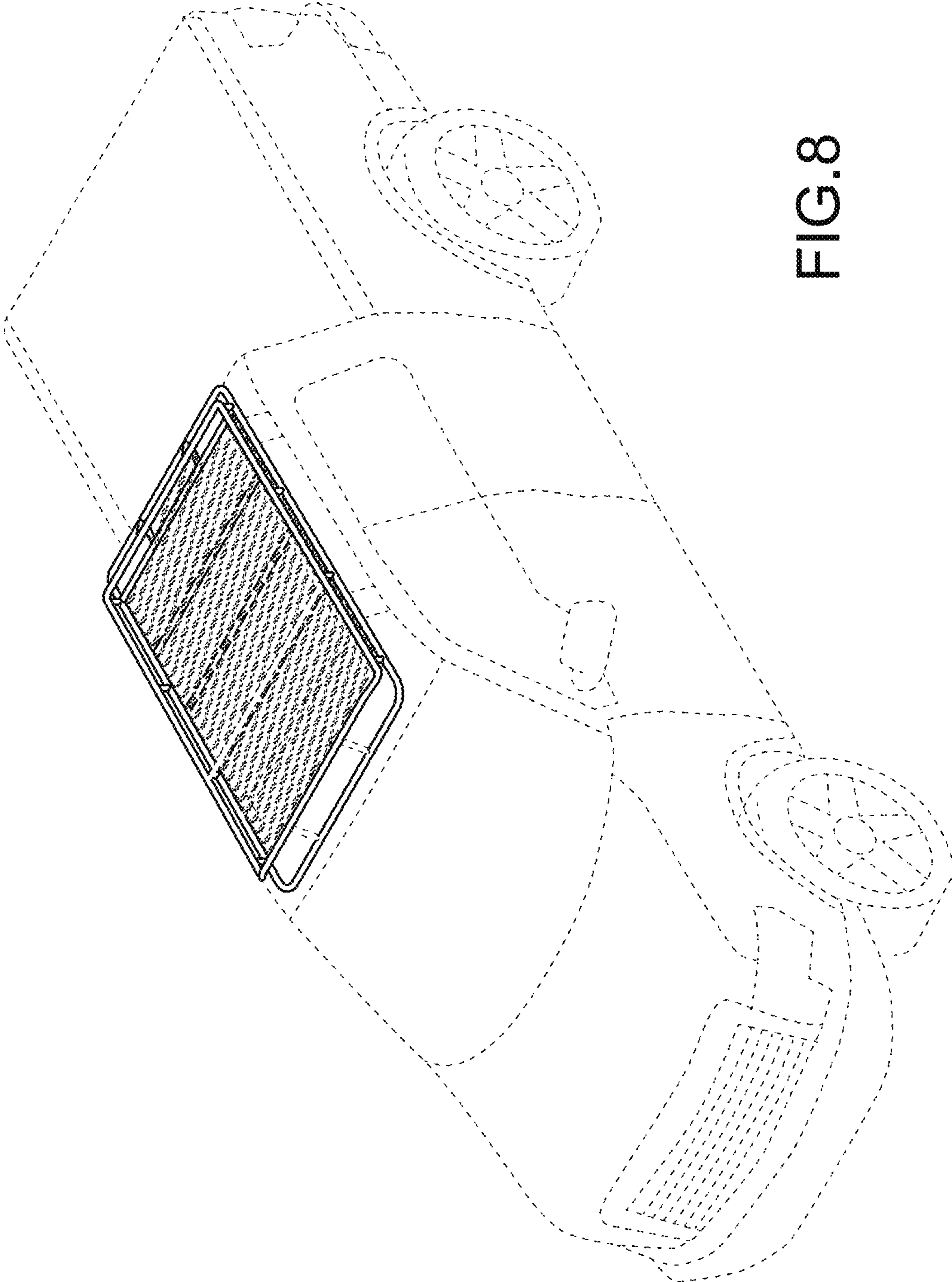

FIG. 8