



US00D793847S

(12) **United States Design Patent**  
**Brannon**

(10) **Patent No.:** **US D793,847 S**

(45) **Date of Patent:** **\*\* Aug. 8, 2017**

(54) **CABINET SPACER**

(71) Applicant: **Sympateco, Inc.**, Omaha, NE (US)

(72) Inventor: **Curt Brannon**, Omaha, NE (US)

(73) Assignee: **SYMPATECO, INC.**, Omaha, NE (US)

(\*\*) Term: **15 Years**

(21) Appl. No.: **29/551,663**

(22) Filed: **Jan. 15, 2016**

(51) **LOC (10) Cl.** ..... **08-05**

(52) **U.S. Cl.**  
USPC ..... **D8/354**

(58) **Field of Classification Search**  
USPC ..... D8/354, 323, 325, 366, 381, 380, 403,  
D8/404, 499, 349; D25/199, 119, 124,  
D25/133; D6/329  
CPC ..... A47B 95/00; A47B 87/00  
See application file for complete search history.

(56) **References Cited**

**U.S. PATENT DOCUMENTS**

2,653,851 A	9/1953	Davidson	
D326,403 S *	5/1992	Kleiss	D25/121
5,350,227 A	9/1994	Katz	
D489,465 S *	5/2004	Allsopp	D25/119
D496,248 S *	9/2004	Liebendorfer	D8/354
D496,249 S *	9/2004	Liebendorfer	D8/354
D557,112 S *	12/2007	Franssen	D8/349
D595,984 S *	7/2009	Kollman	D6/580
D600,533 S *	9/2009	Cole	D8/349
D601,000 S *	9/2009	Cole	D8/349

(Continued)

**OTHER PUBLICATIONS**

[http://www.feycohardware.com/product\\_p/8012.htm](http://www.feycohardware.com/product_p/8012.htm).  
<http://www.sleekworld.com/imported-kitchen-products/scilm/1-gola-profile-channel-type-detail.html>.

*Primary Examiner* — Rosemary K Tarcza

*Assistant Examiner* — Alison Ofstun

(74) *Attorney, Agent, or Firm* — Ryan T. Grace; Advent, LLP

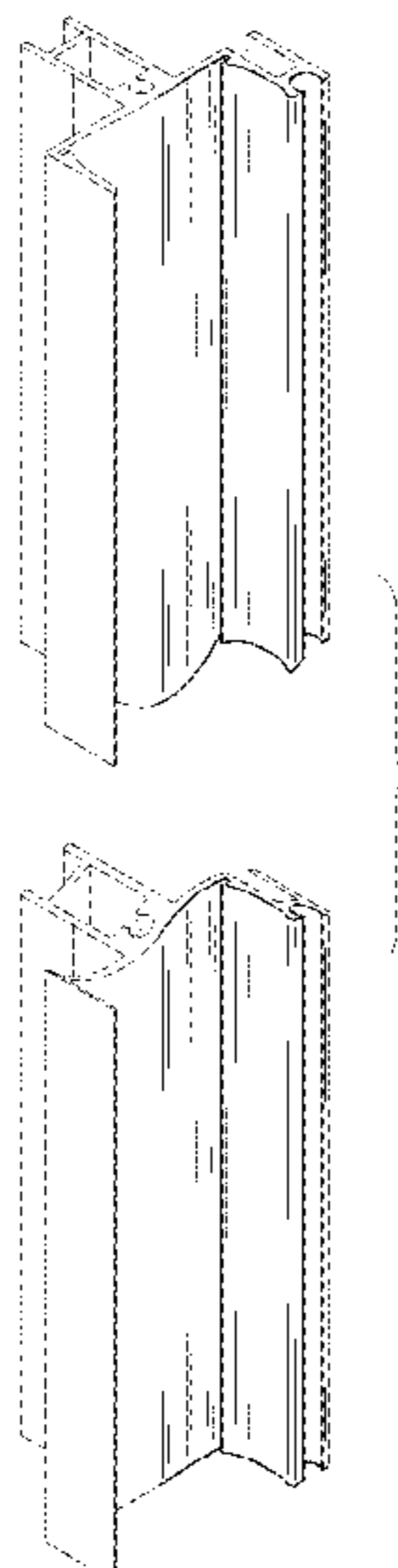
(57) **CLAIM**

The ornamental design for a cabinet spacer, as shown and described.

**DESCRIPTION**

FIG. 1 is a top plan view of a cabinet spacer.  
FIG. 2 is a bottom view of the cabinet spacer of FIG. 1.  
FIG. 3 is a front elevation view of the cabinet spacer of FIG. 1.  
FIG. 4 is a rear elevation view of the cabinet spacer of FIG. 1.  
FIG. 5 is a left side elevation view of the cabinet spacer of FIG. 1.  
FIG. 6 is a right side elevation view of the cabinet spacer of FIG. 1.  
FIG. 7 is an isometric view of the cabinet spacer of FIG. 1.  
FIG. 8 is a top plan view of a cabinet spacer.  
FIG. 9 is a bottom view of the cabinet spacer of FIG. 8.  
FIG. 10 is a front elevation view of the cabinet spacer of FIG. 8.  
FIG. 11 is a rear elevation view of the cabinet spacer of FIG. 8.  
FIG. 12 is a left side elevation view of the cabinet spacer of FIG. 8.  
FIG. 13 is a right side elevation view of the cabinet spacer of FIG. 8; and,  
FIG. 14 is an isometric view of the cabinet spacer of FIG. 8. Portions of FIGS. 1 through 14 are shown in broken lines illustrating portions of the article that form no part of the claimed design. The cabinet spacer is shown with a symbolic break in its length. The appearance of any portion of the article between the break lines forms no part of the claimed design.

**1 Claim, 14 Drawing Sheets**



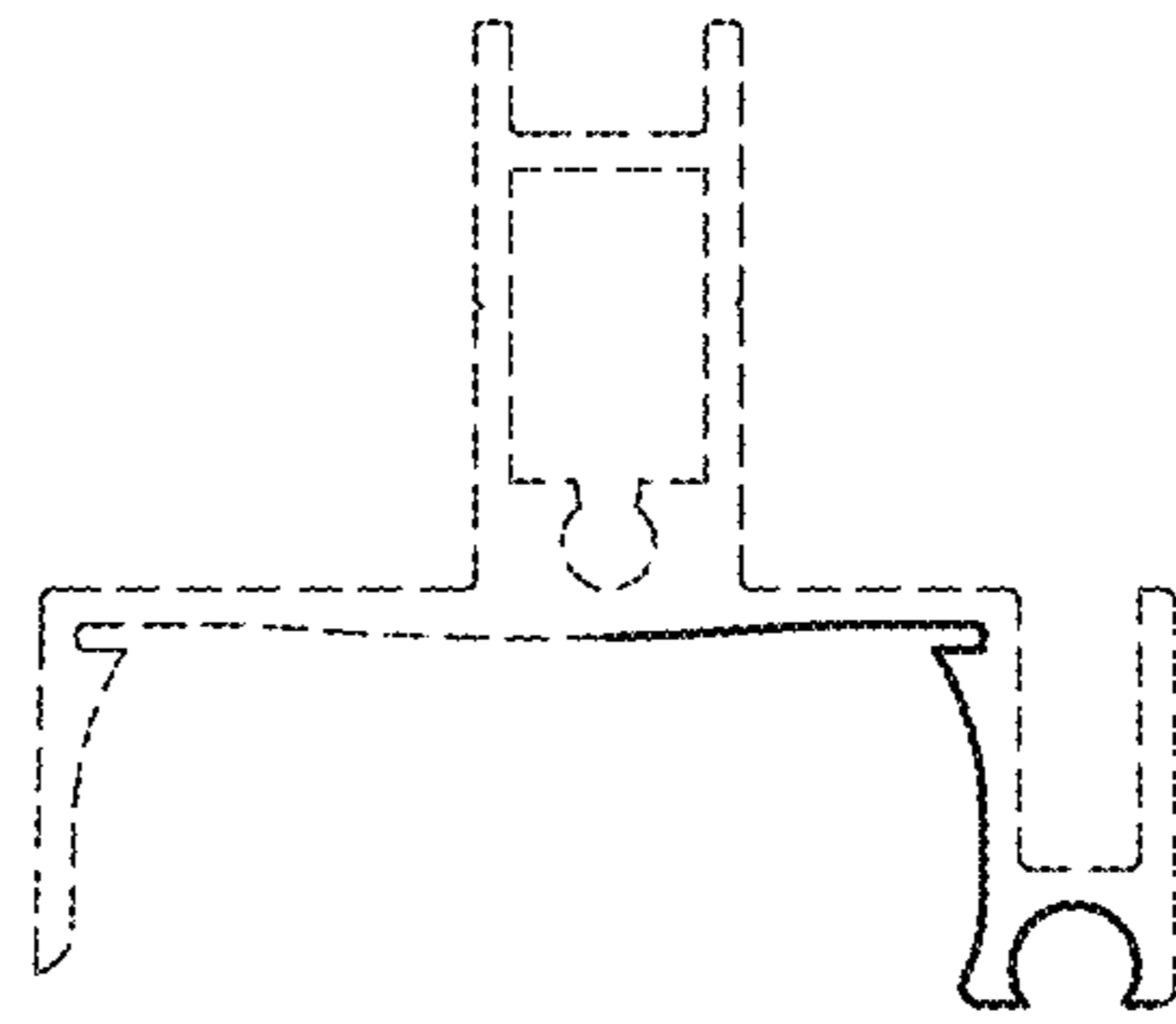
(56)

**References Cited**

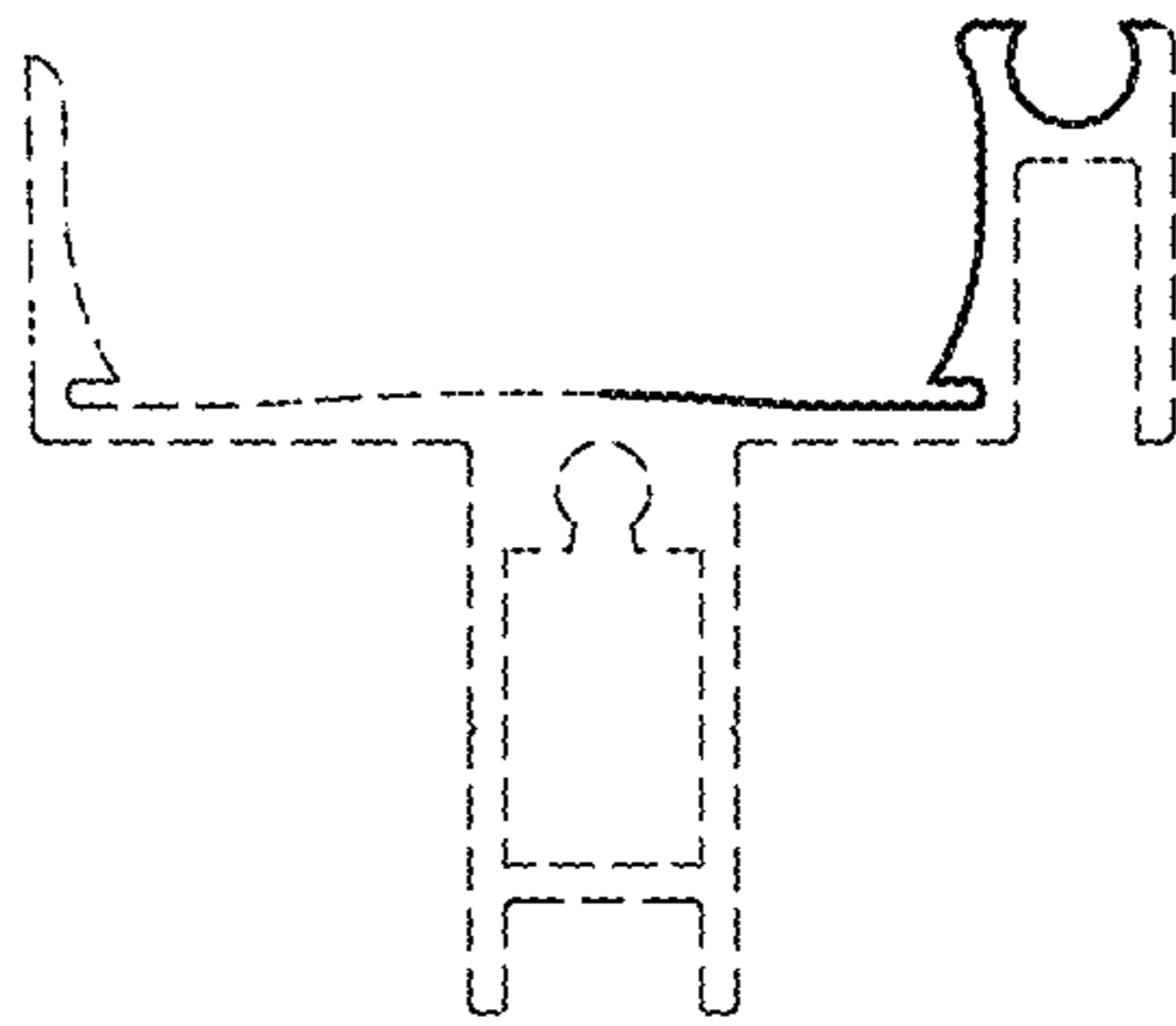
U.S. PATENT DOCUMENTS

D631,325	S	*	1/2011	Azuma	.....	D8/354
D652,986	S	*	1/2012	Trzesniowski	.....	D26/138
D744,667	S	*	12/2015	Macdonald	.....	D25/124
D751,024	S	*	3/2016	Burhanidust	.....	D12/223
D753,425	S	*	4/2016	Johansson	.....	D25/119
D755,041	S	*	5/2016	Weldon	.....	D8/377
2016/0213561	A1	*	7/2016	McLane	.....	A61H 33/6005

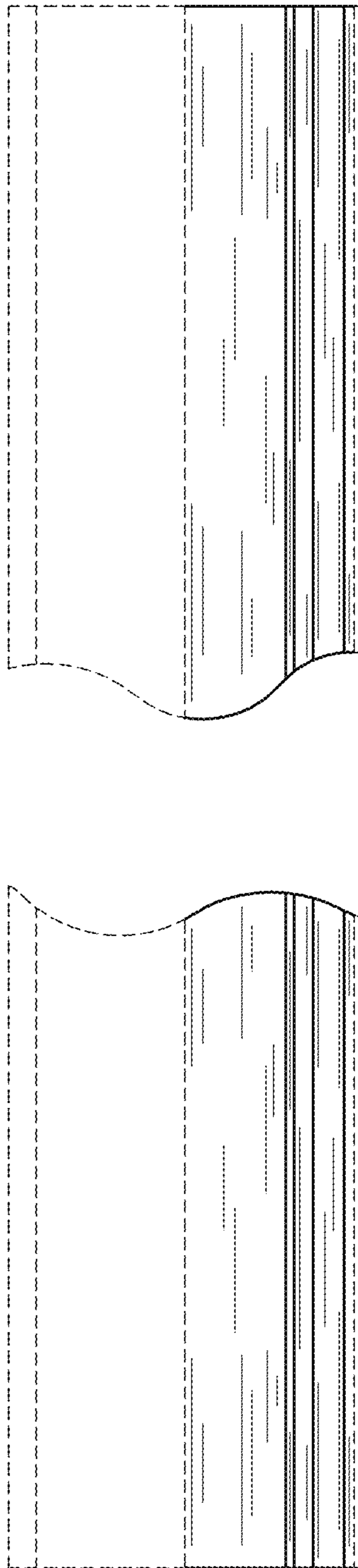
\* cited by examiner



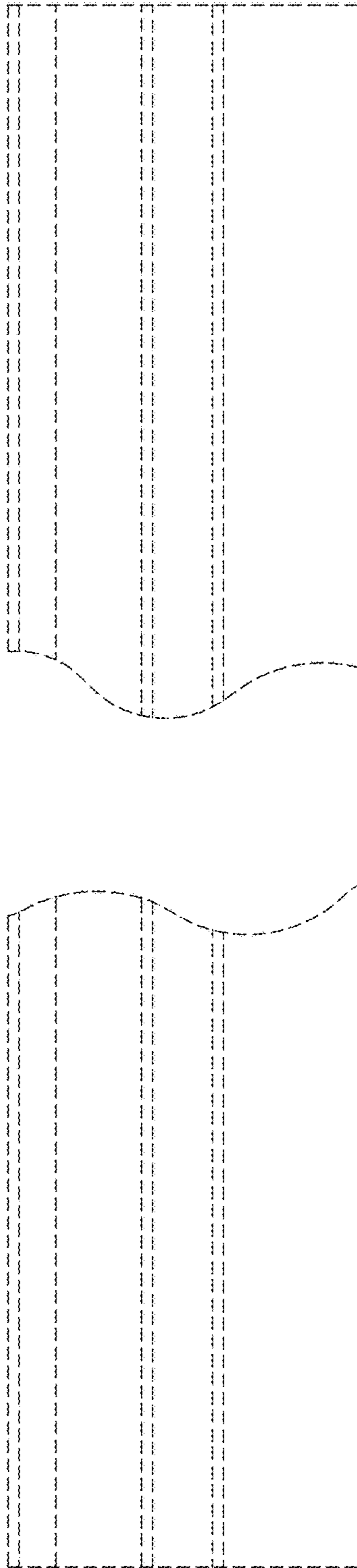
**FIG. 1**



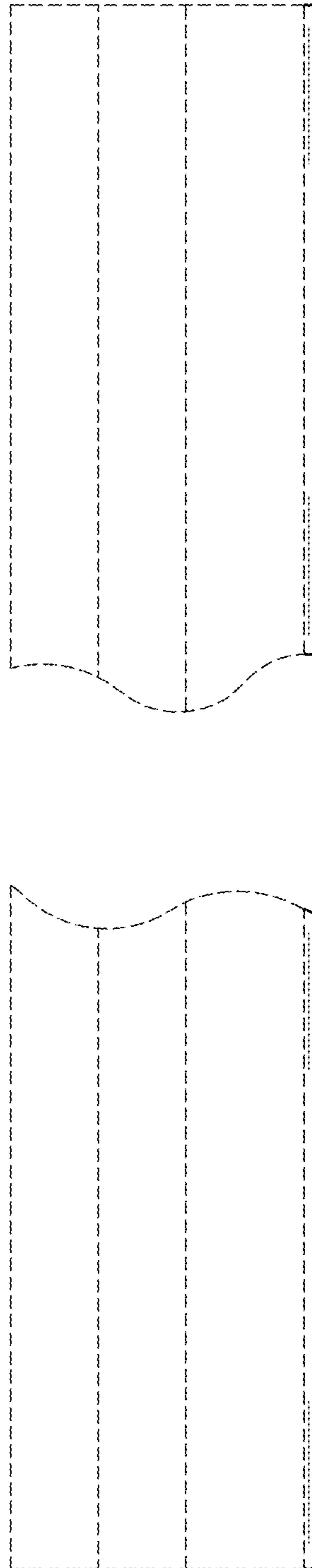
**FIG. 2**



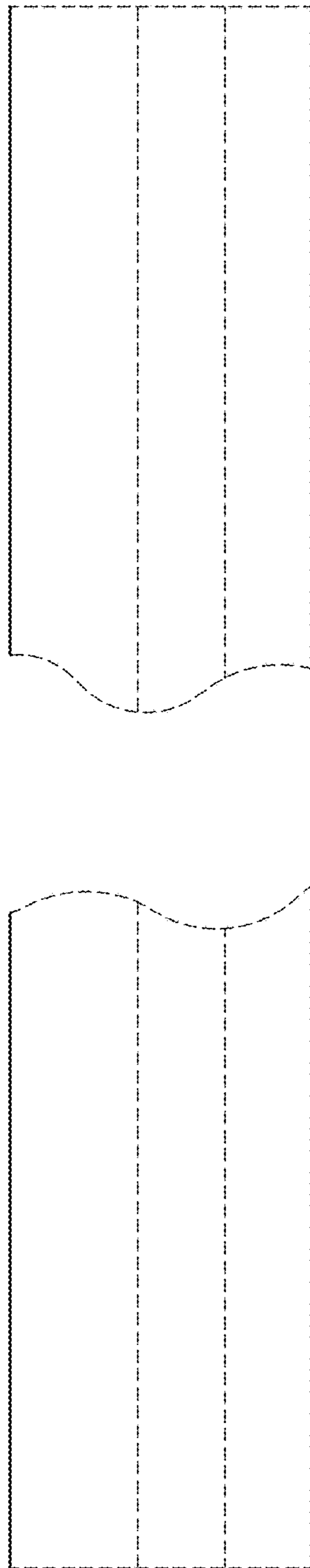
**FIG. 3**



**FIG. 4**

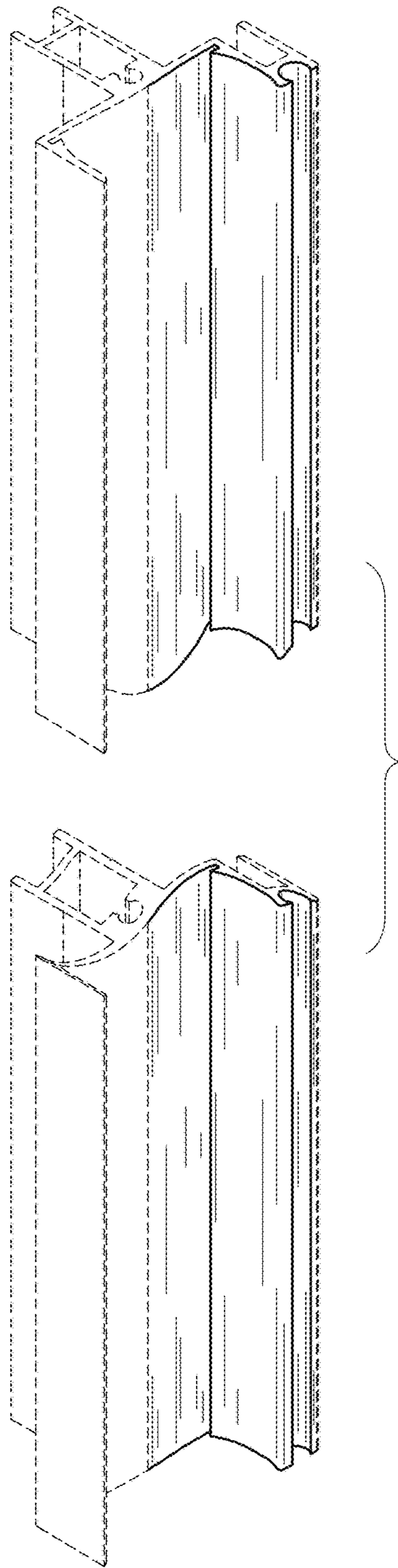


**FIG. 5**

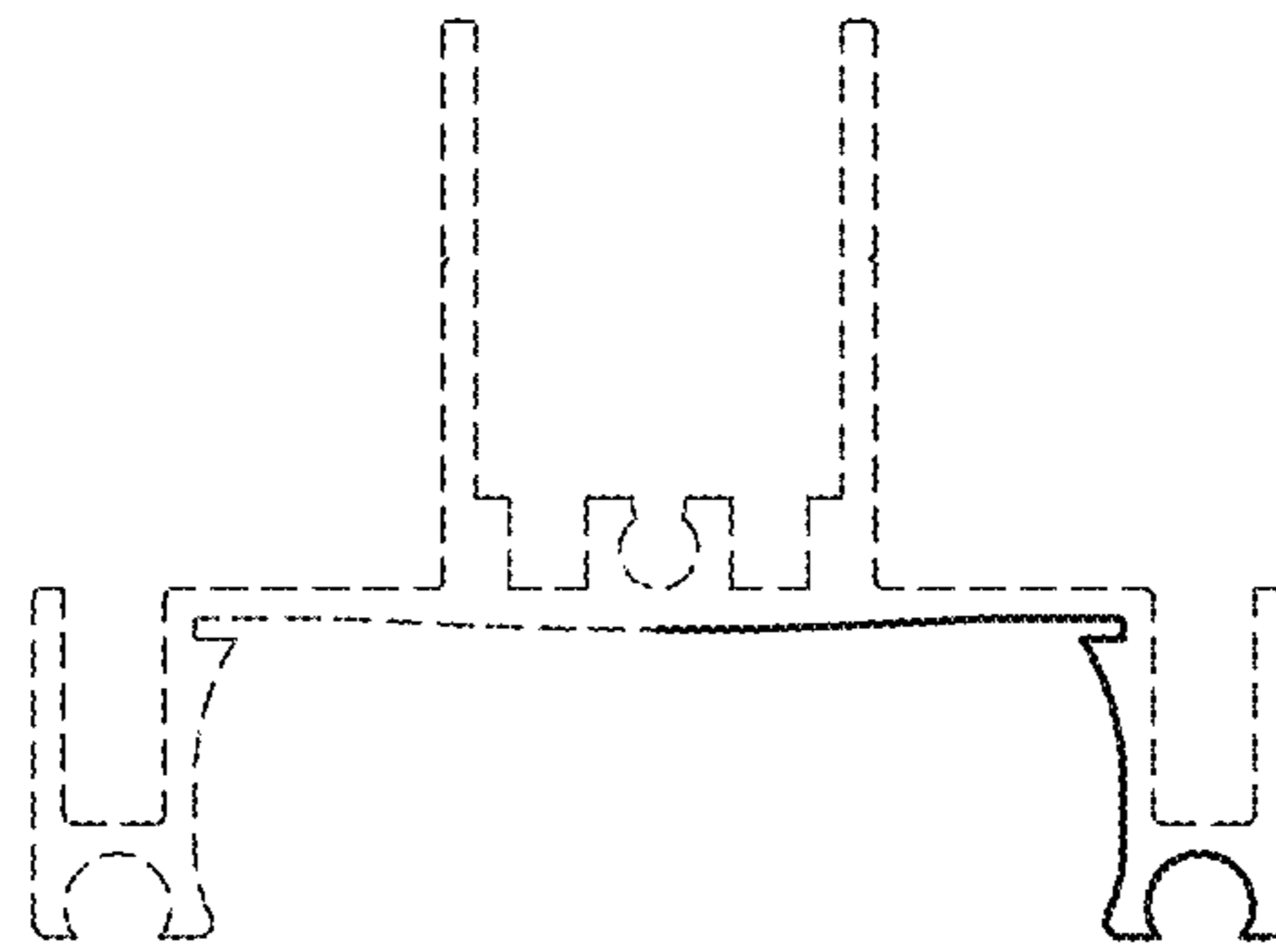


**FIG. 6**

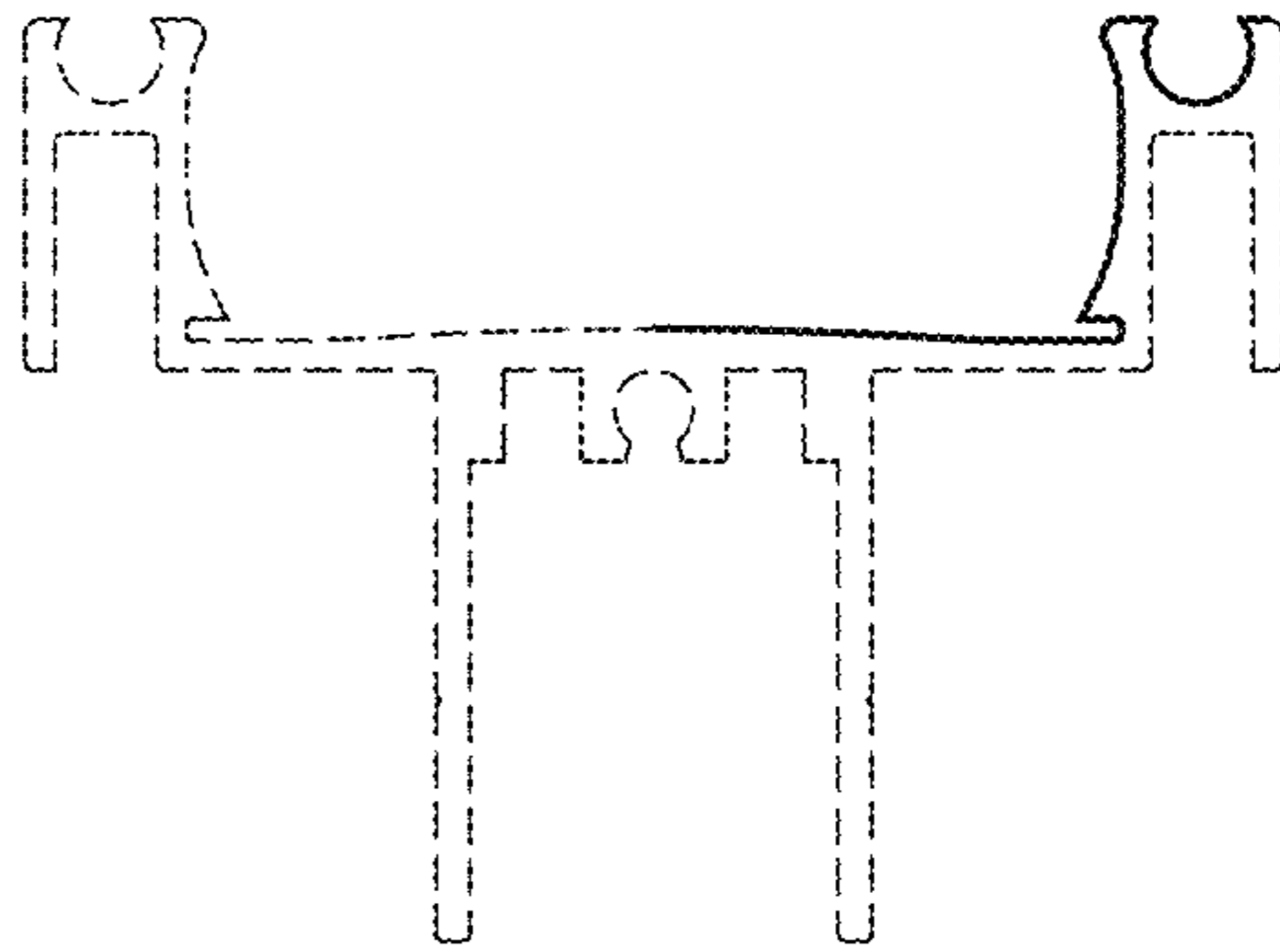




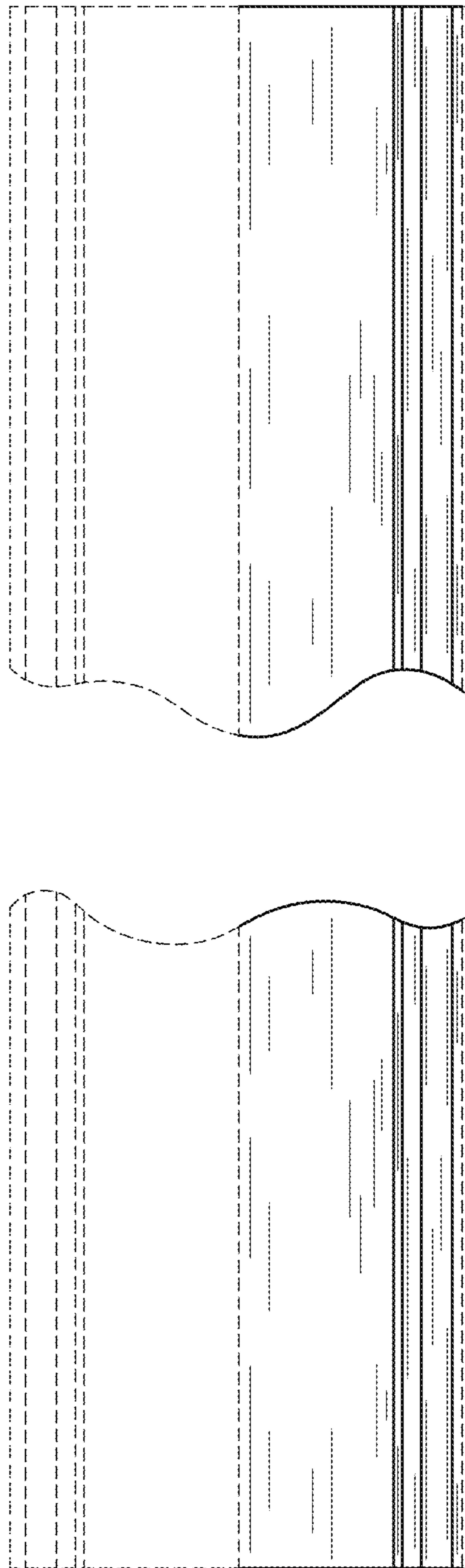
**FIG. 7**



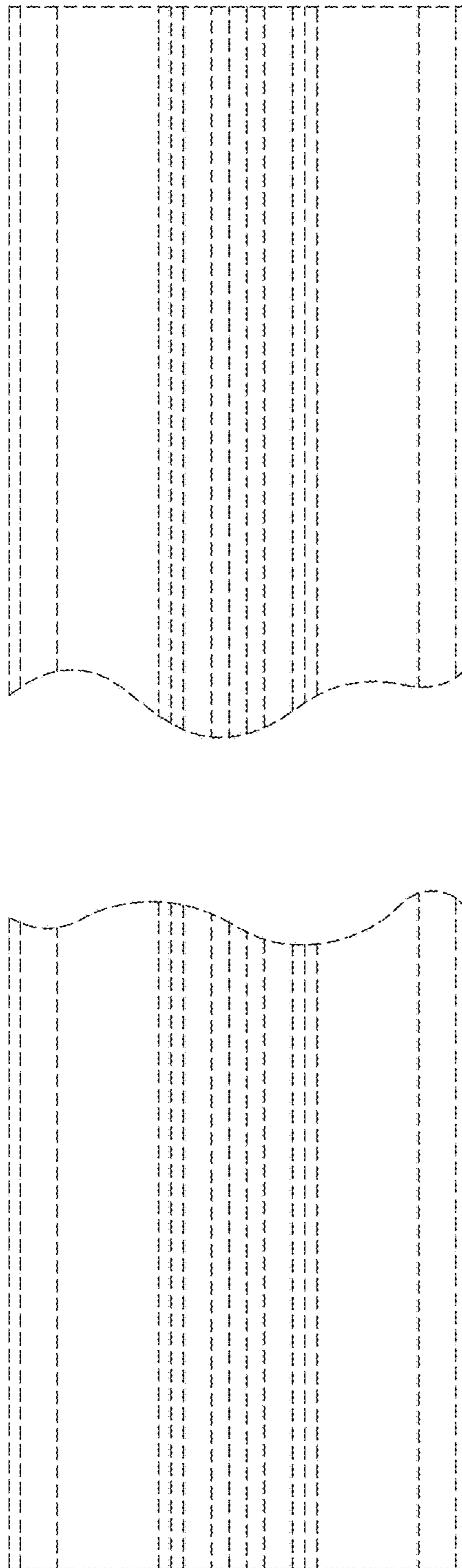
**FIG. 8**



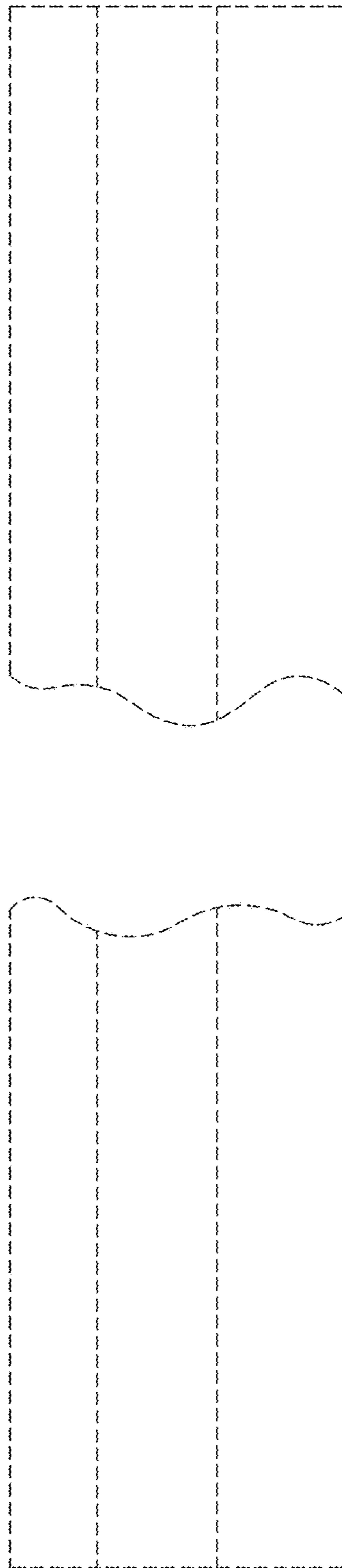
**FIG. 9**



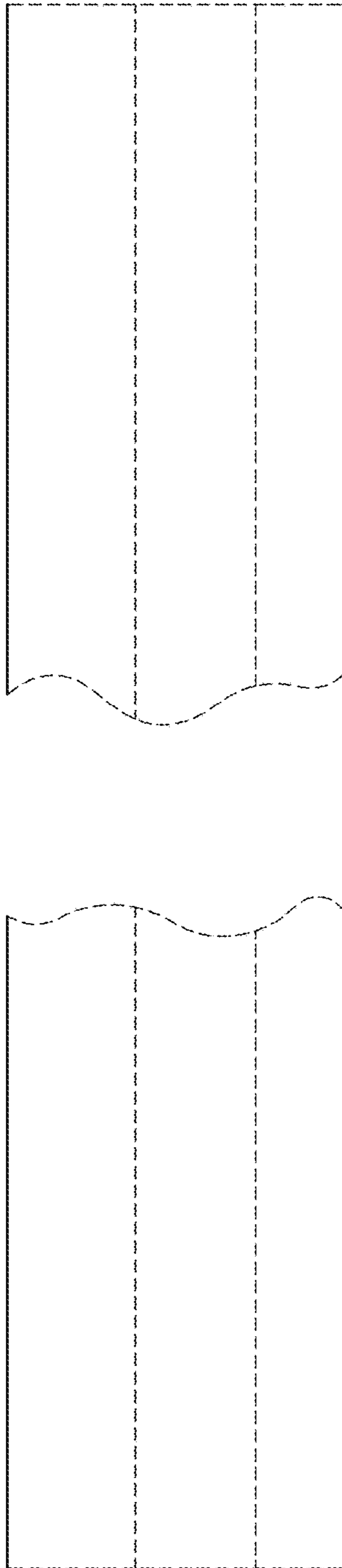
**FIG. 10**



**FIG. 11**



**FIG. 12**



**FIG. 13**

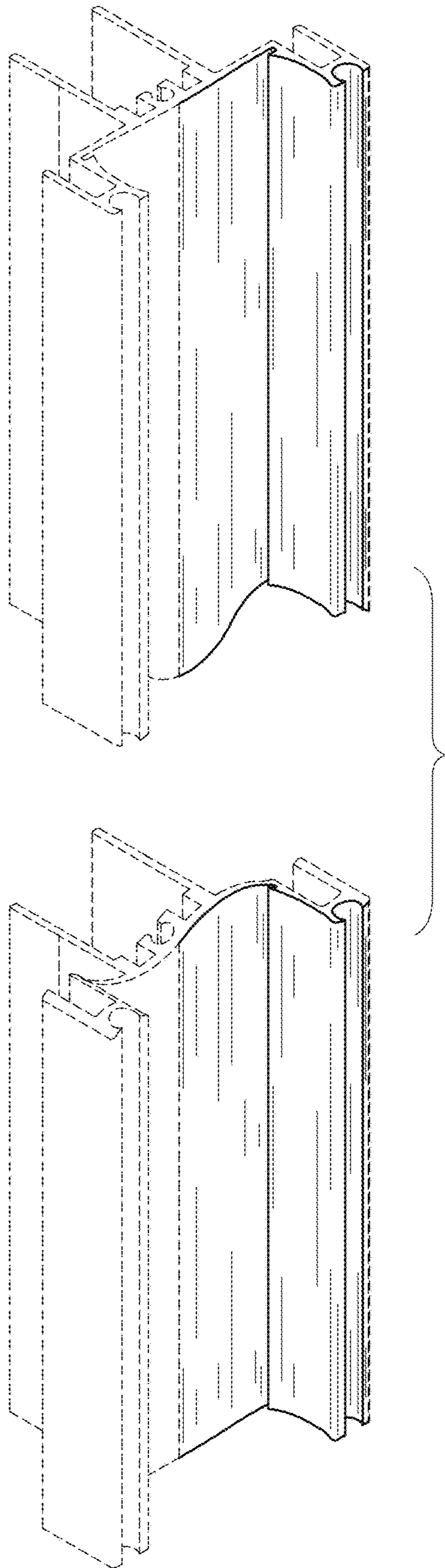


FIG. 14