



US00D793827S

(12) **United States Design Patent**  
**Huang**

(10) **Patent No.:** **US D793,827 S**

(45) **Date of Patent:** **\*\* Aug. 8, 2017**

(54) **HOT AIR GUN BODY**

(71) Applicant: **Yeu Chyuan Industrial Co., Ltd.**,  
Shuishang Township, Chiayi County  
(TW)

(72) Inventor: **Yung-Kuan Huang**, Shuishang  
Township (TW)

(73) Assignee: **Yeu-Chyuan Industrial Co., Ltd.**,  
Chiayi County (TW)

(\*\*) Term: **15 Years**

(21) Appl. No.: **29/566,135**

(22) Filed: **May 27, 2016**

(51) **LOC (10) Cl.** ..... **08-05**

(52) **U.S. Cl.**  
USPC ..... **D8/29.1**

(58) **Field of Classification Search**  
USPC ..... D8/29.1, 30, 61; D28/12, 13  
CPC ..... F24H 3/0423; F24H 3/02; F24H 3/0488;  
F24H 3/002; F24H 9/2071  
See application file for complete search history.

(56) **References Cited**

**U.S. PATENT DOCUMENTS**

D436,507 S \* 1/2001 Cheng ..... D8/29.1  
D456,681 S \* 5/2002 Cheng ..... D8/29.1

D457,043 S \* 5/2002 Cheng ..... D8/29.1  
D458,524 S \* 6/2002 Cheng ..... D8/29.1  
D458,818 S \* 6/2002 Cheng ..... D8/29.1  
D475,590 S \* 6/2003 Huang ..... D8/29.1  
D648,606 S \* 11/2011 Sallander ..... D8/29.1  
8,948,577 B2 \* 2/2015 Eberli ..... F24H 3/0423  
392/379  
D743,764 S \* 11/2015 Teraoka ..... D8/29.1

\* cited by examiner

*Primary Examiner* — Phillip S Hyder

(74) *Attorney, Agent, or Firm* — Alan D. Kamrath;  
Kamrath IP Lawfirm, P.A.

(57) **CLAIM**

The ornamental design for a hot air gun body, as shown and described.

**DESCRIPTION**

FIG. 1 is a perspective view of a hot air gun body, showing my new design;  
FIG. 2 is a front elevational view thereof;  
FIG. 3 is a rear elevational view thereof;  
FIG. 4 is a left side view thereof;  
FIG. 5 is a right side view thereof;  
FIG. 6 is a top plan view thereof; and,  
FIG. 7 is a bottom plan view thereof.

The broken lines depict portions of the hot air gun body in which the design is embodied that are not considered part of the claimed design.

**1 Claim, 4 Drawing Sheets**

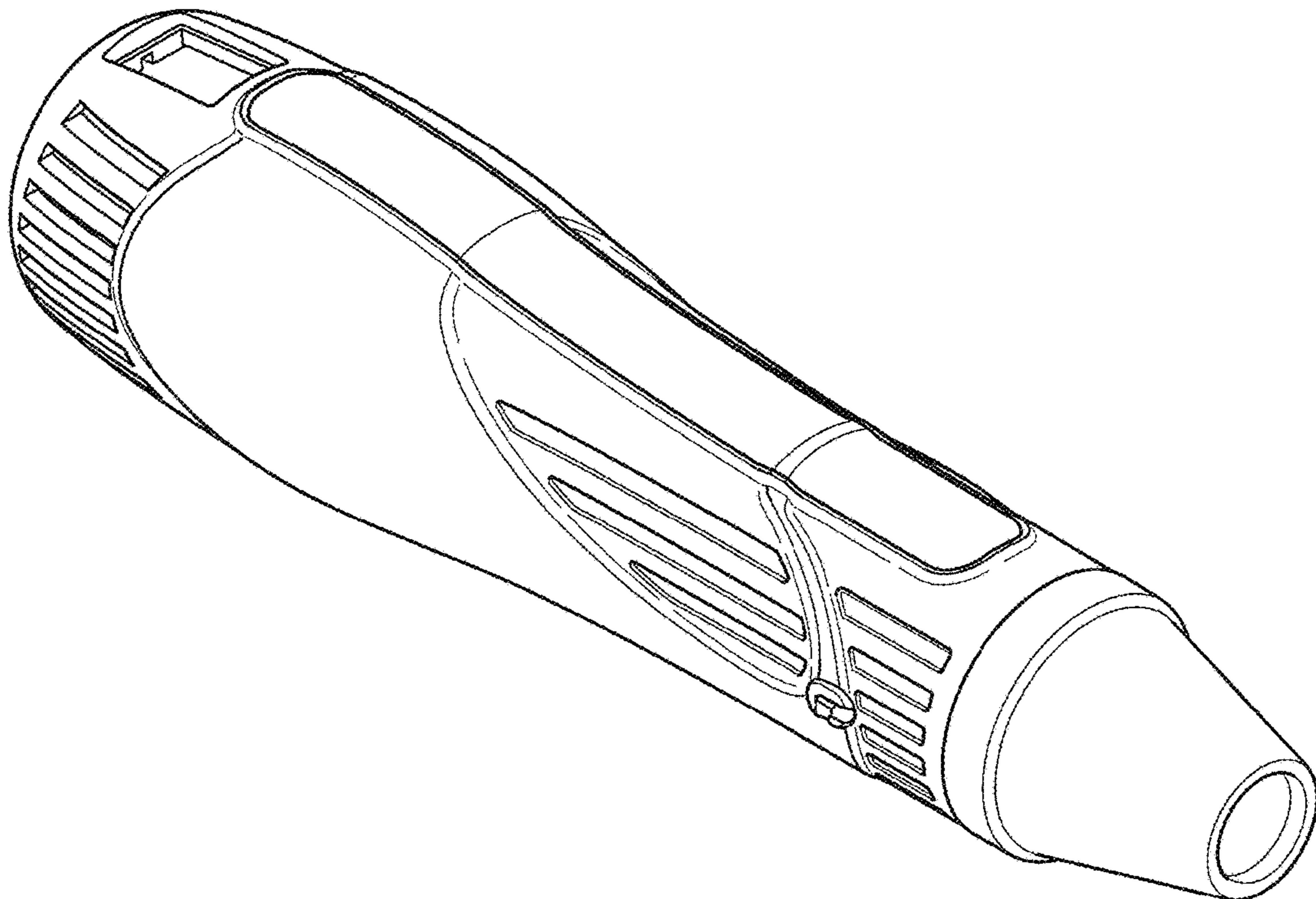

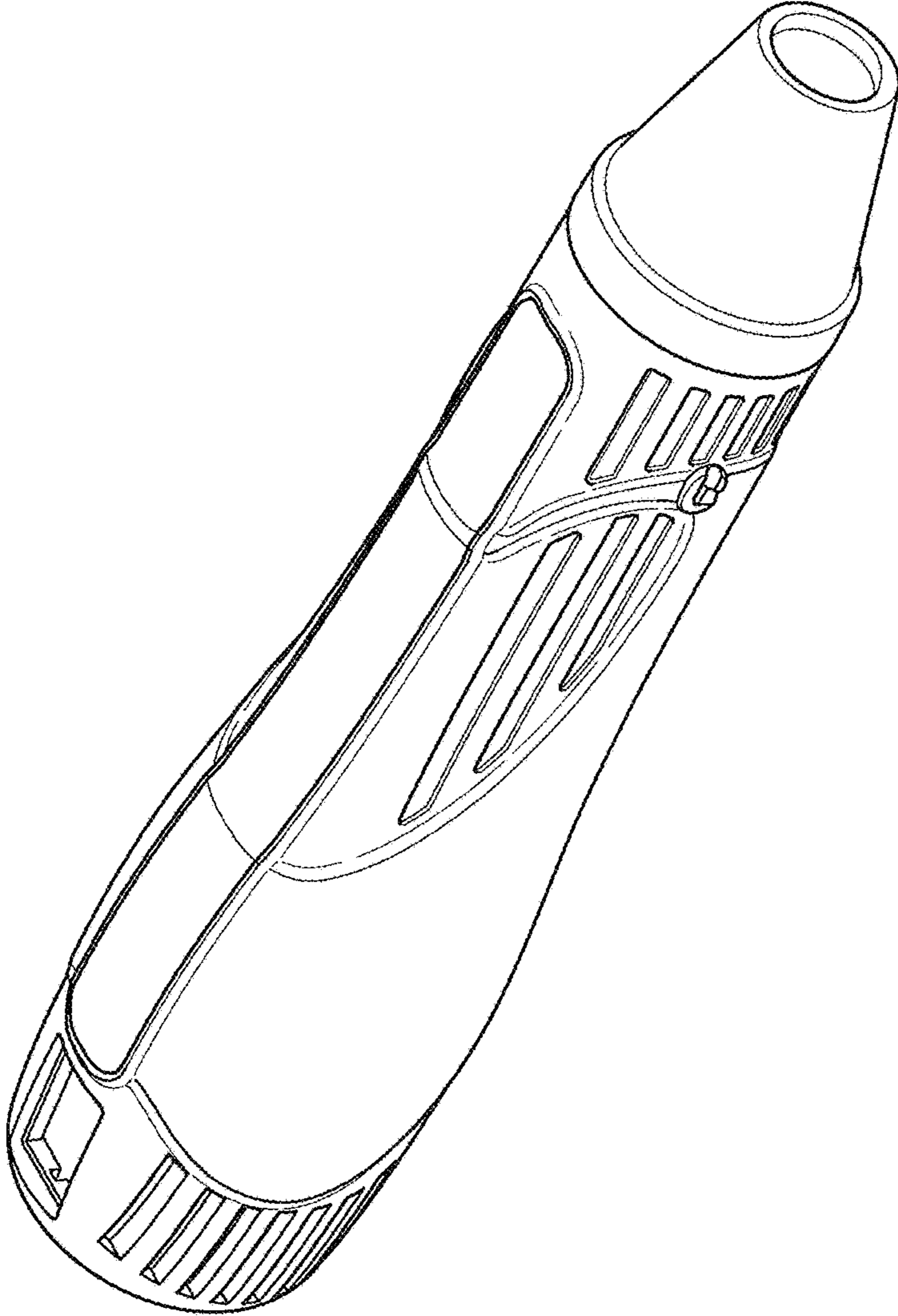

FIG. 1

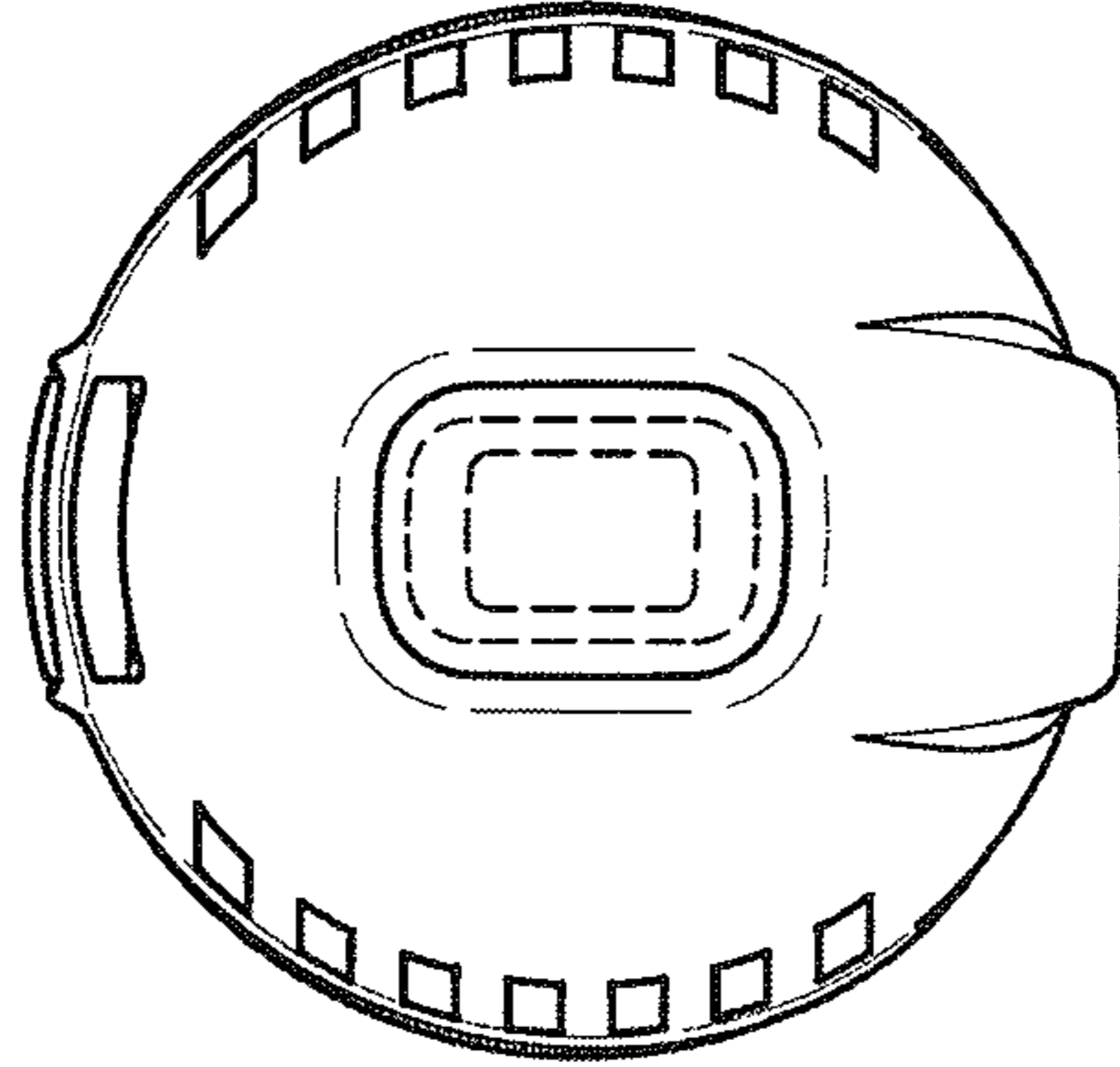

FIG. 3

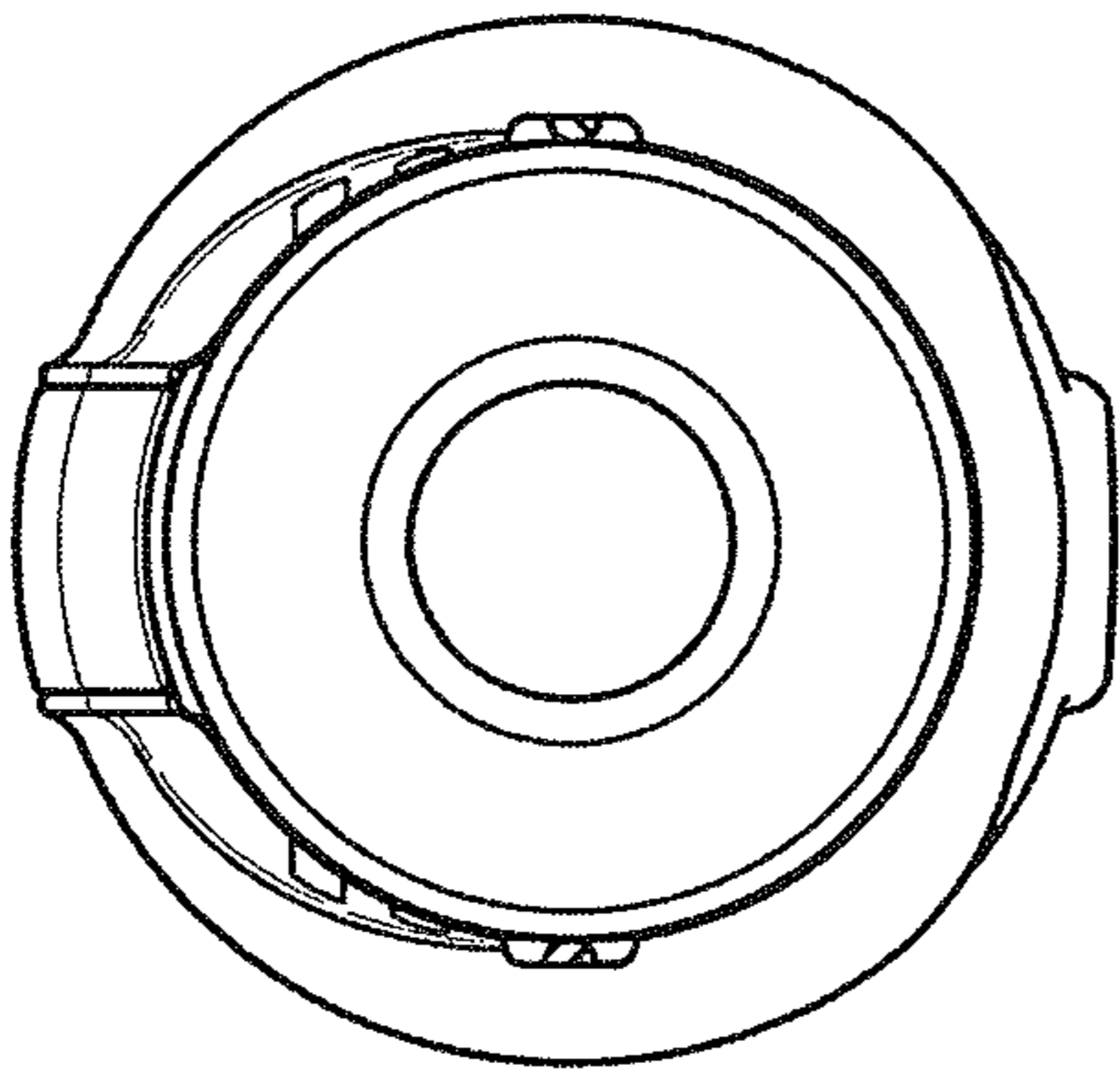

FIG. 2

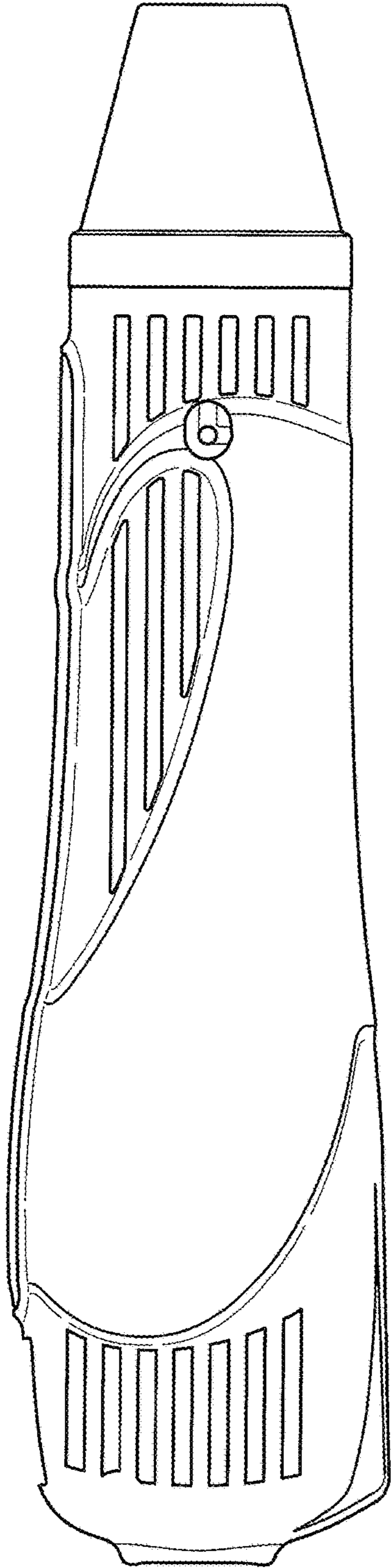

FIG. 4

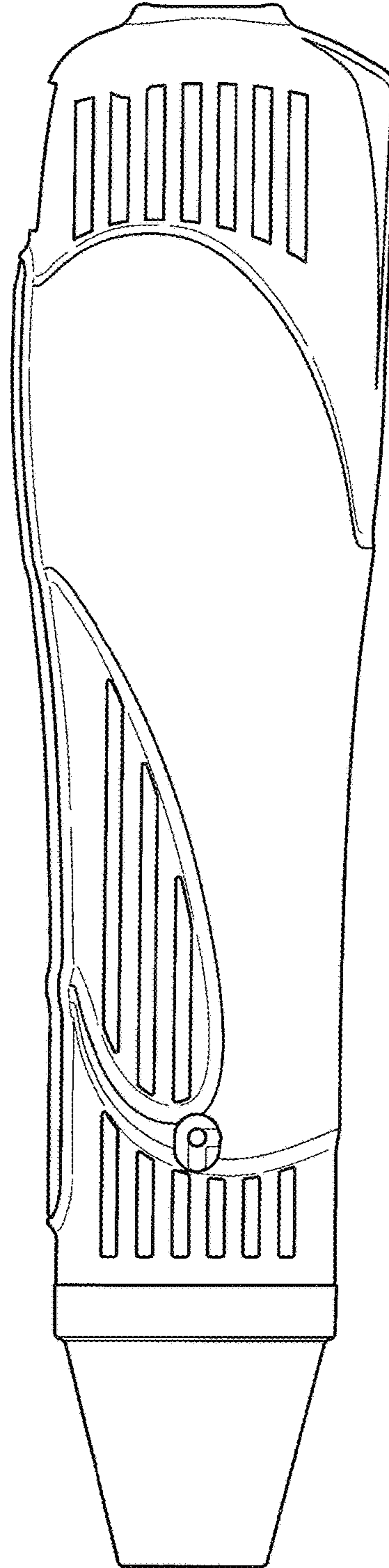

FIG. 5

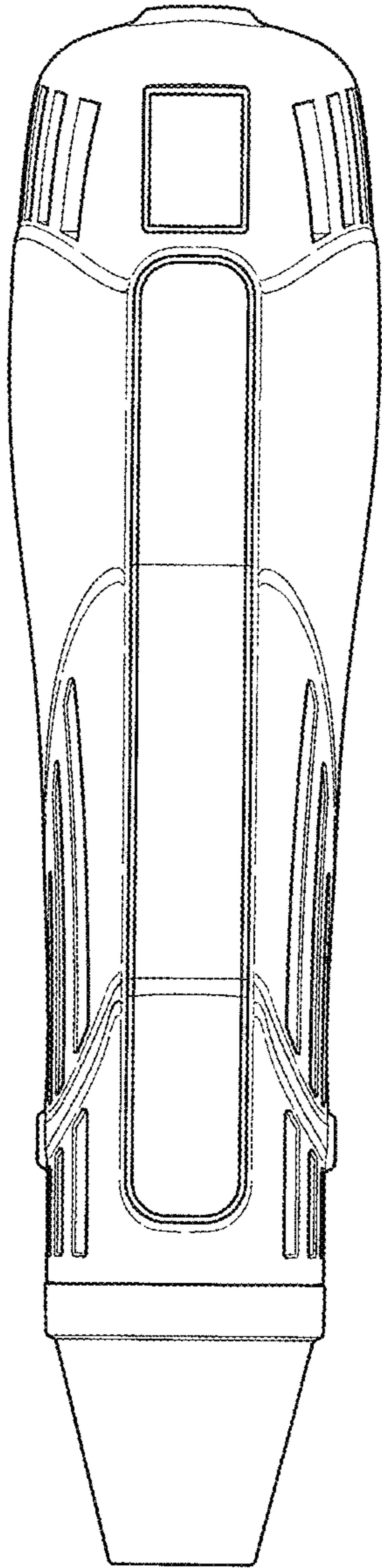

FIG. 6

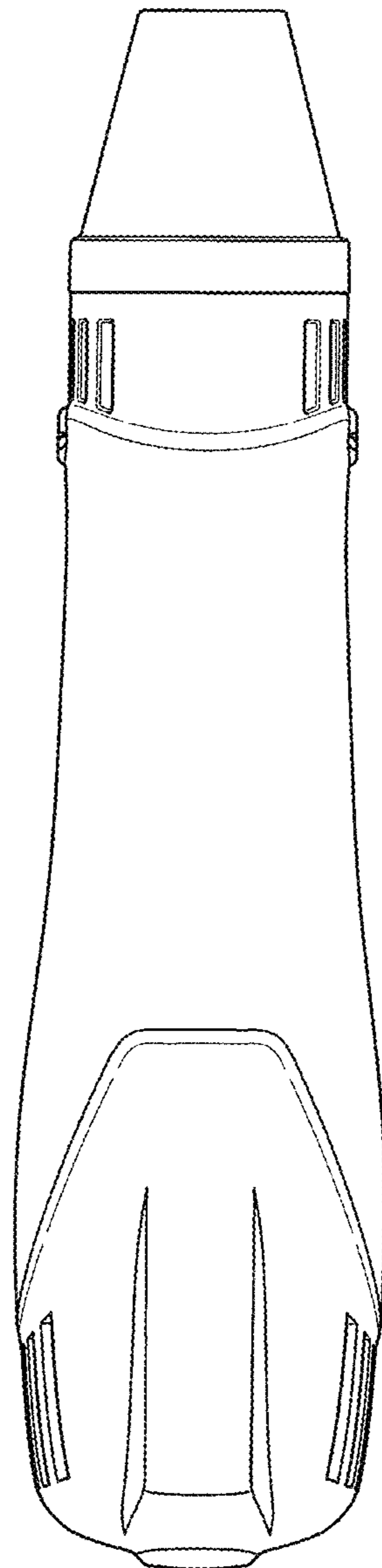

FIG. 7