



US00D793791S

(12) **United States Design Patent** (10) **Patent No.:** **US D793,791 S**
McDonald et al. (45) **Date of Patent:** **** Aug. 8, 2017**

(54) **BEER DISPENSER**
(71) Applicant: **Fizzics Group LLC**, Manchester, NH (US)
(72) Inventors: **David Arlen McDonald**, Merimack, NH (US); **Phillip Petracca**, Howell, NJ (US)
(73) Assignee: **Fizzics Group LLC**, Manchester, NH (US)

(**) Term: **15 Years**

(21) Appl. No.: **29/567,515**

(22) Filed: **Jun. 9, 2016**

(51) **LOC (10) Cl.** **07-01**

(52) **U.S. Cl.**
USPC **D7/313; D7/306**

(58) **Field of Classification Search**
USPC D7/300, 304-311, 312, 313; 222/325, 222/185.1

CPC A47J 31/00; B67D 1/00; B67D 1/0003; B67D 1/0004; B67D 1/0005; F25D 23/126; Y10T 137/00; Y10T 137/0318; Y10T 137/0379; C12C 13/02

See application file for complete search history.

(56) **References Cited**

U.S. PATENT DOCUMENTS

4,003,499 A 1/1977 Shapiro
4,470,526 A 9/1984 Cha

6,824,013 B2 11/2004 Harrison
D518,677 S * 4/2006 Van Berlo D7/306
8,597,593 B2 12/2013 Boehm
D738,152 S * 9/2015 Grasselli D7/309
D763,613 S * 8/2016 Han D7/306
9,533,865 B2* 1/2017 Sonnichsen B67D 1/0004
2011/0127298 A1 6/2011 Shah
2015/0336785 A1* 11/2015 Rege B67D 1/0418
222/1

* cited by examiner

Primary Examiner — Daniel Bui

Assistant Examiner — Andrew Kerr

(74) *Attorney, Agent, or Firm* — Keeley DeAngelo LLP

(57) **CLAIM**

The ornamental design for a beer dispenser, as shown and described.

DESCRIPTION

FIG. 1 is a front right perspective view of a beer dispenser showing our new design;
FIG. 2 is a rear right perspective view thereof;
FIG. 3 is a front side view thereof;
FIG. 4 is a right side view thereof;
FIG. 5 is a rear side view thereof;
FIG. 6 is a left side view thereof;
FIG. 7 is a top plan view thereof; and,
FIG. 8 is a bottom plan view thereof.

The portions shown in broken lines are for illustrative purposes only, and form no part of the claimed design. In general, bold lines define outer edges of forms while fine lines define contours on surfaces.

1 Claim, 8 Drawing Sheets

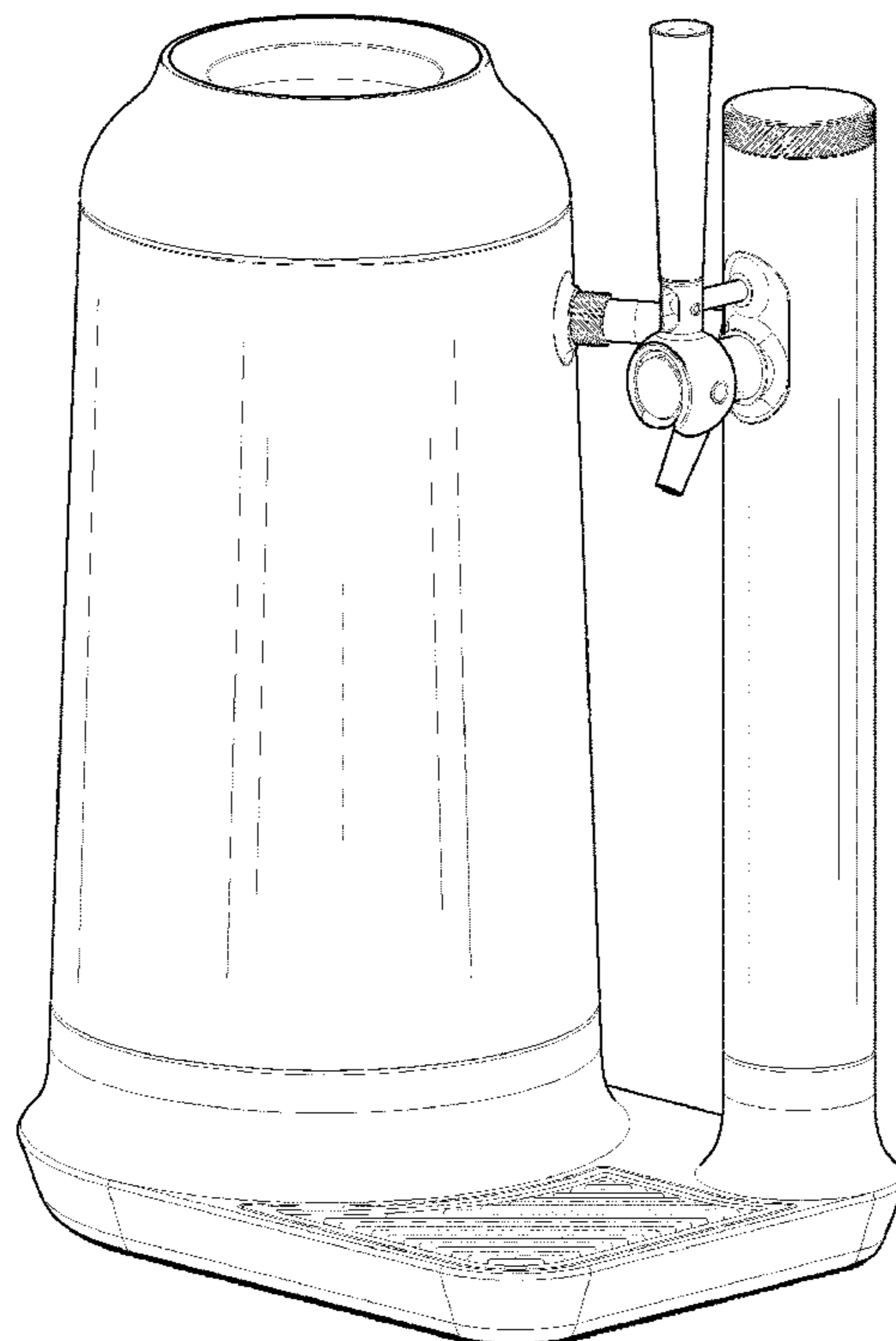

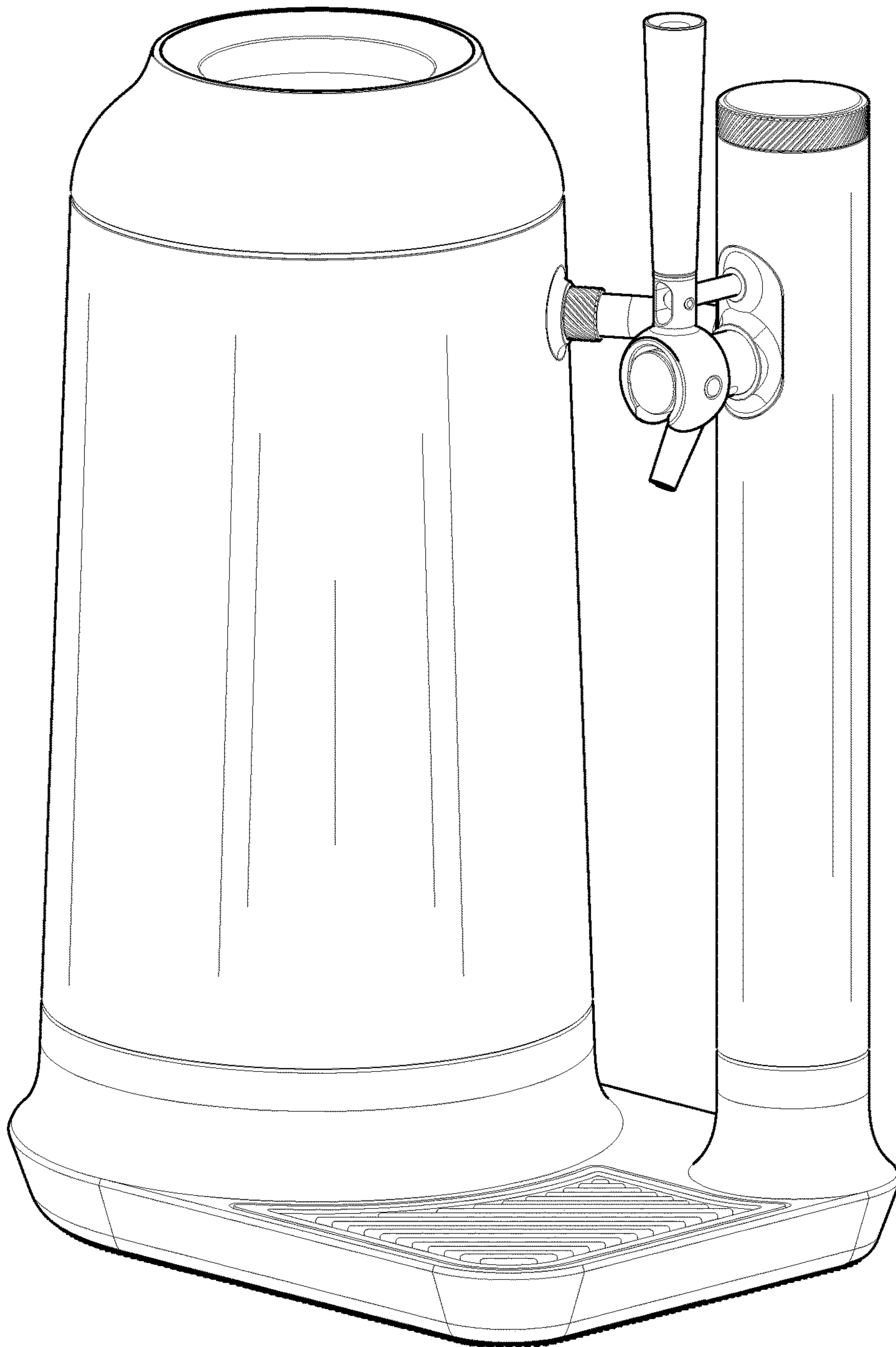

Figure 1

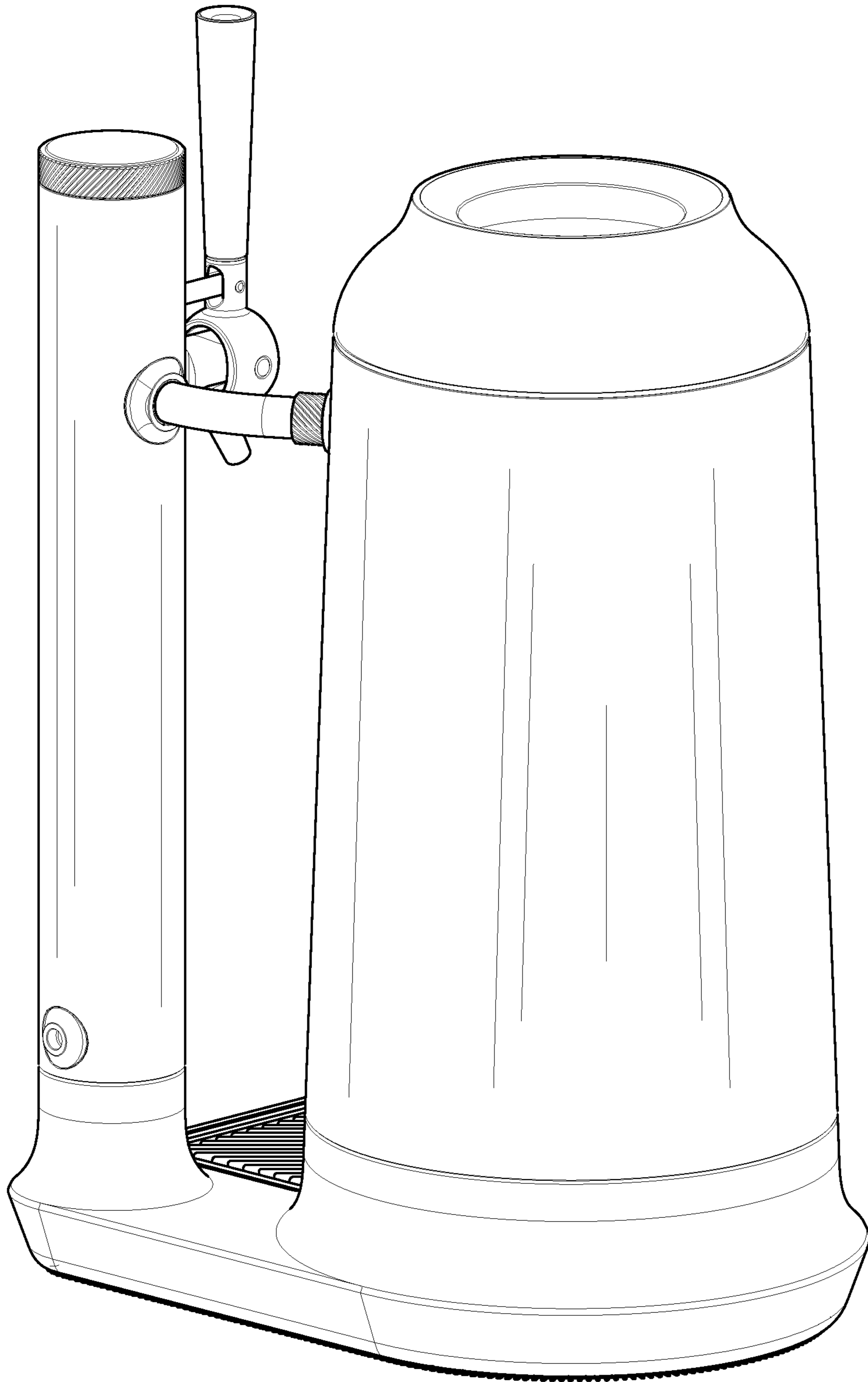

Figure 2

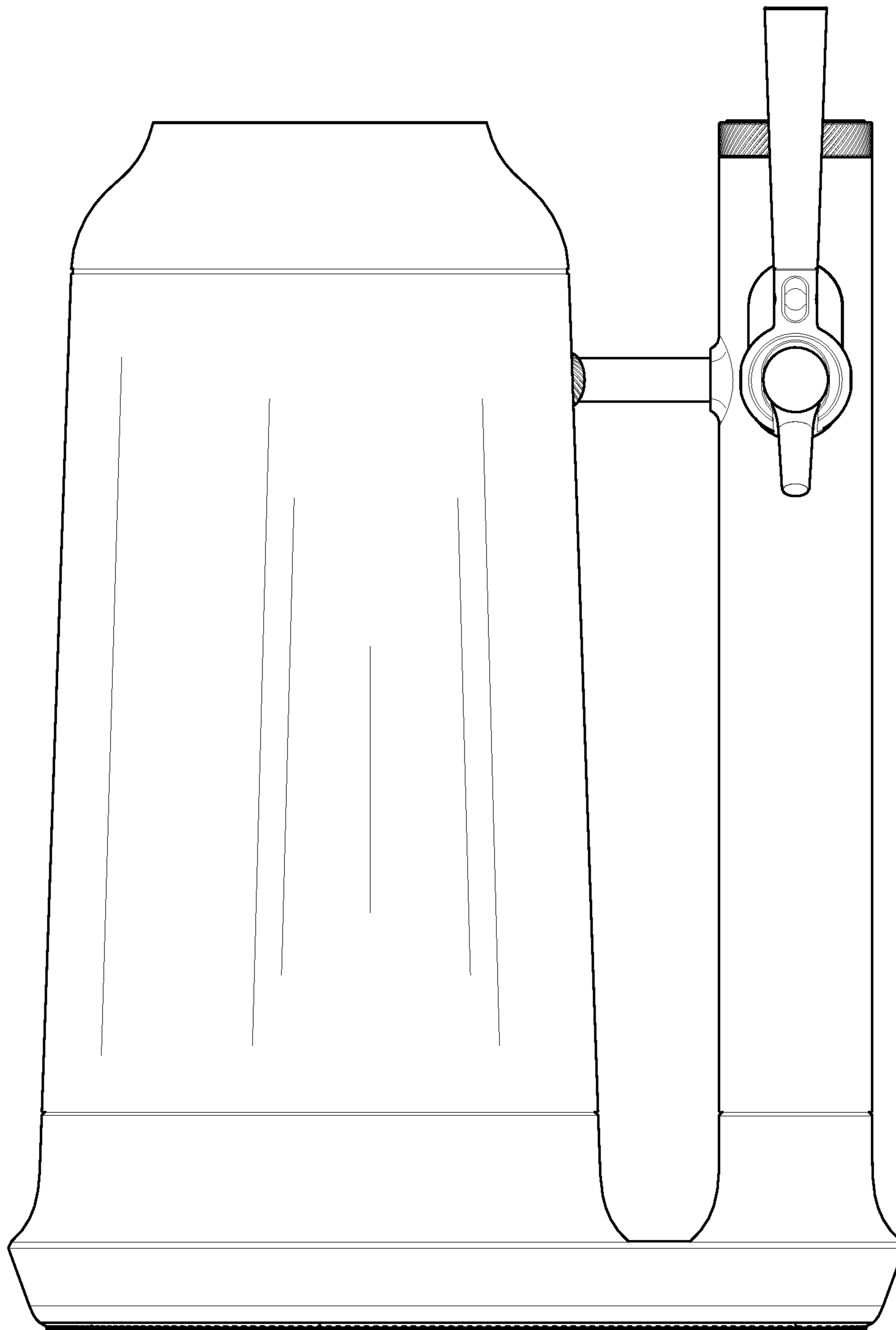

Figure 3

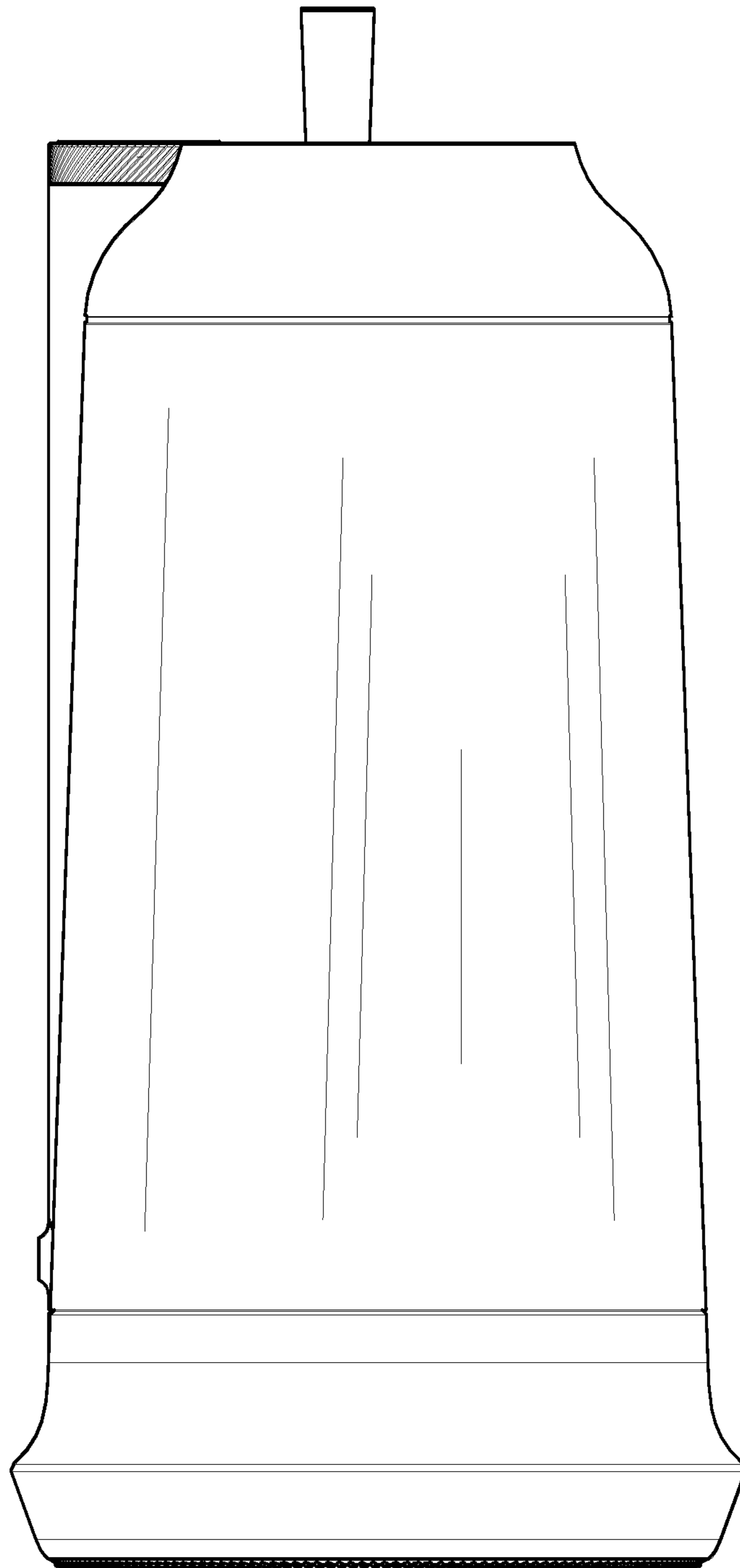

Figure 4

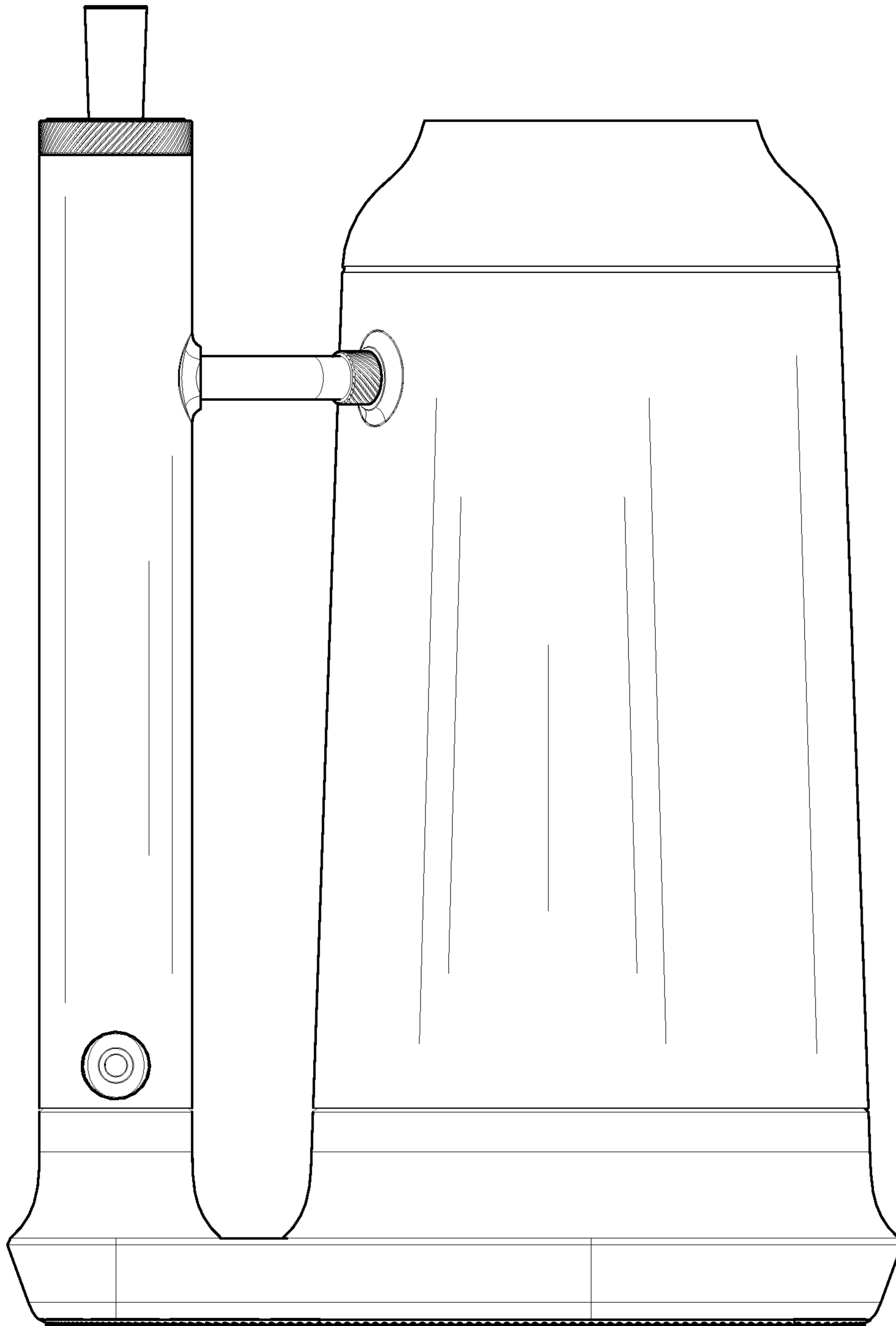

Figure 5

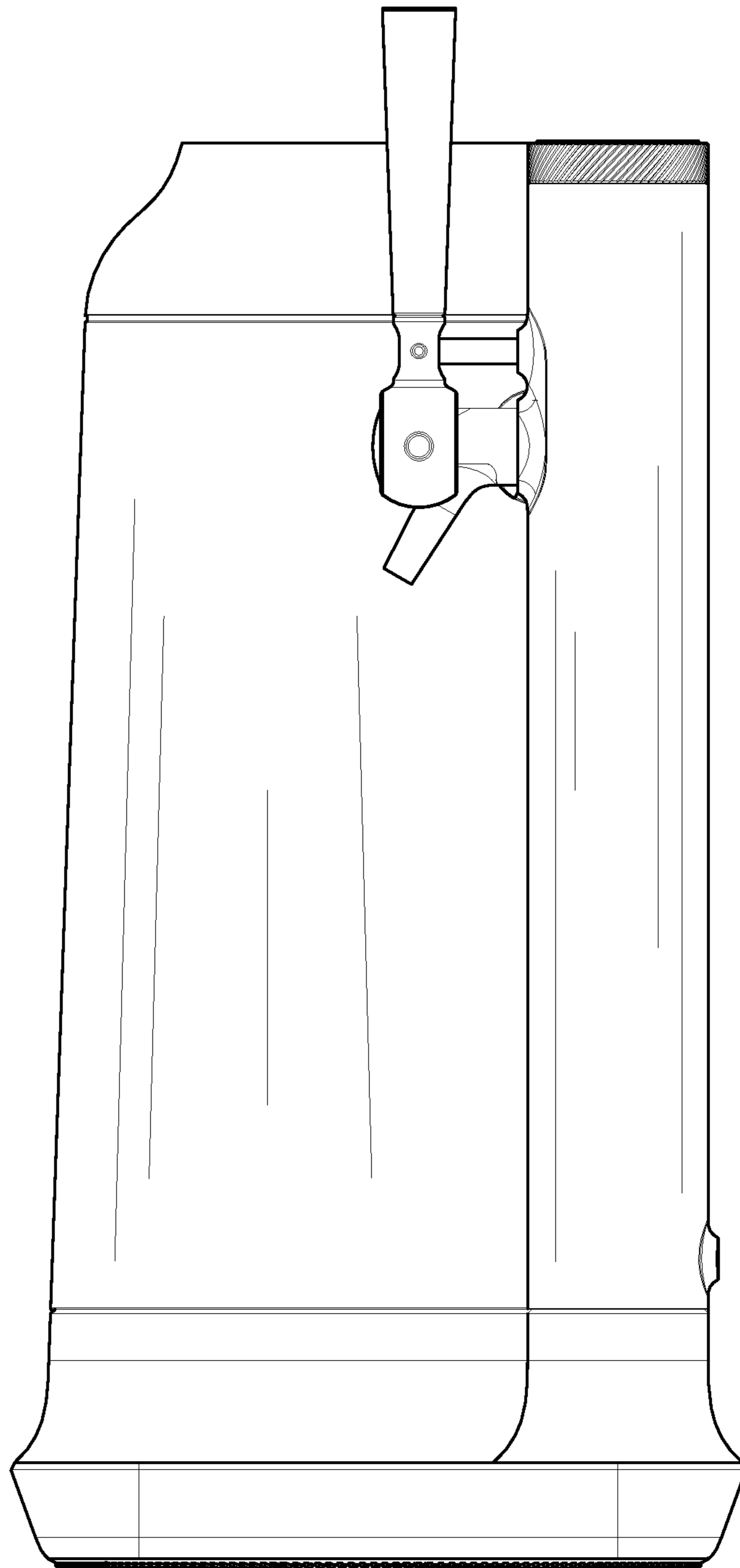

Figure 6

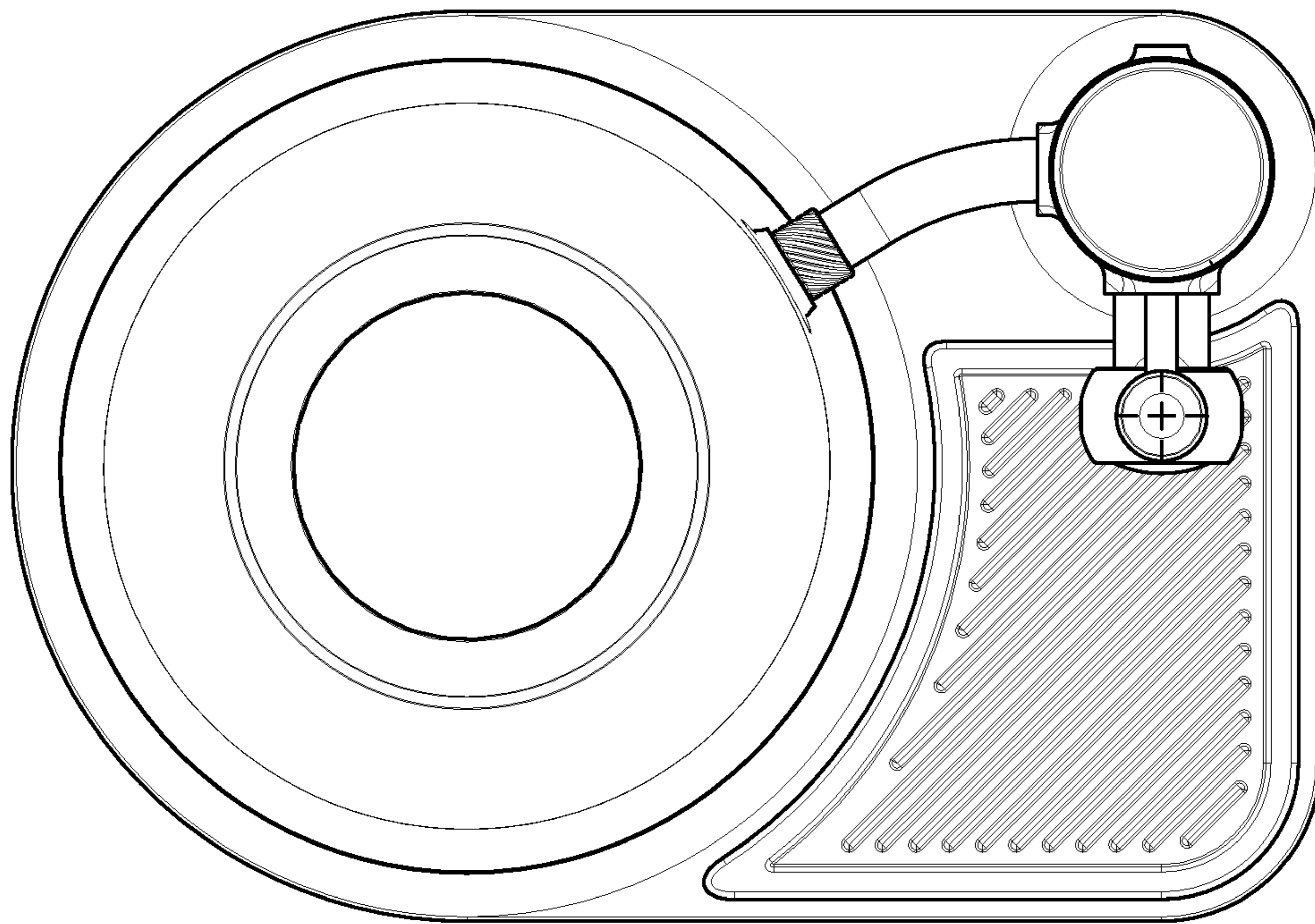

Figure 7

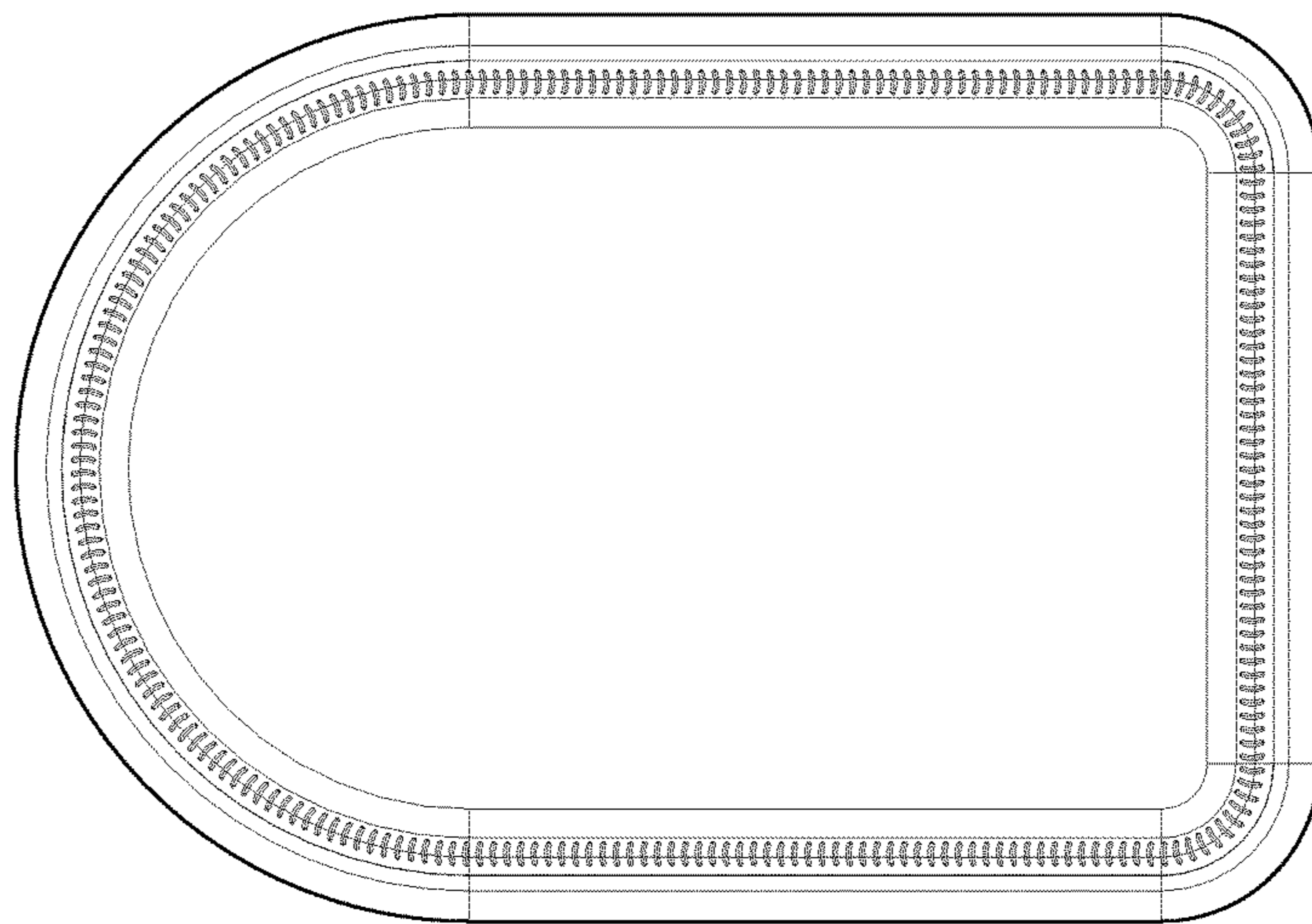

Figure 8