



US00D793678S

(12) **United States Design Patent** (10) **Patent No.:** **US D793,678 S**
Burns et al. (45) **Date of Patent:** **** Aug. 8, 2017**

(54) **TOE GUARD**
(71) Applicants: **Joseph Burns**, Mauston, WI (US);
Thomas Burns, Mauston, WI (US)
(72) Inventors: **Joseph Burns**, Mauston, WI (US);
Thomas Burns, Mauston, WI (US)
(**) Term: **15 Years**
(21) Appl. No.: **29/546,260**
(22) Filed: **Nov. 20, 2015**
(51) **LOC (10) Cl.** **02-99**
(52) **U.S. Cl.**
USPC **D2/913; D2/946**
(58) **Field of Classification Search**
USPC D2/902, 906-908, 944, 946, 969,
D2/972-974
CPC ... A43B 13/181; A43B 13/141; A43B 13/186;
A43B 13/188; A43B 23/00; A43B 23/02;
A43B 5/00; A43B 23/26; A43B 1/04;
A43B 11/14; A43B 7/00; A43C 1/00;
A43C 11/00
See application file for complete search history.

(56) **References Cited**
U.S. PATENT DOCUMENTS
280,264 A * 6/1883 Walker A43B 7/32
36/72 R
3,487,830 A 1/1970 Pruett
3,773,041 A 11/1973 Bogar, Jr. et al.
4,554,872 A 11/1985 Schleicher
4,735,003 A * 4/1988 Dykeman A43B 23/087
36/72 R
D398,142 S * 9/1998 Benoit D2/946

5,832,633 A * 11/1998 Wang A43B 23/086
36/77 M
D423,198 S * 4/2000 Peterson D2/909
D440,754 S * 4/2001 Bathum D2/972
6,272,771 B1 8/2001 Rodi
6,286,234 B1 * 9/2001 Smith, Jr. A43C 13/14
36/131
D493,275 S * 7/2004 Koyess D2/913
6,836,980 B2 1/2005 Woods
D518,946 S * 4/2006 Williams D2/972
D522,223 S * 6/2006 Murphy D2/972
7,373,741 B1 5/2008 Brown
D594,219 S * 6/2009 Dillenbeck D2/946
D646,472 S * 10/2011 Chen D2/909
D657,545 S * 4/2012 Frappier D2/972
D669,667 S * 10/2012 Sakurai D2/946
D723,250 S 3/2015 Taylor

* cited by examiner
Primary Examiner — Dominic Simone

(57) **CLAIM**
The ornamental design for a toe guard, as shown and described.

DESCRIPTION
FIG. 1 is a front view of a toe guard showing my new design;
FIG. 2 is a rear view of the toe guard;
FIG. 3 is a left side view of the toe guard, a right side view being a mirror image thereof;
FIG. 4 is a top view of the toe guard;
FIG. 5 is a bottom view of the toe guard; and,
FIG. 6 is a top front side perspective view of the toe guard in use.
The broken line showing of footwear is for environmental purposes only and form no part of the claimed design.

1 Claim, 5 Drawing Sheets

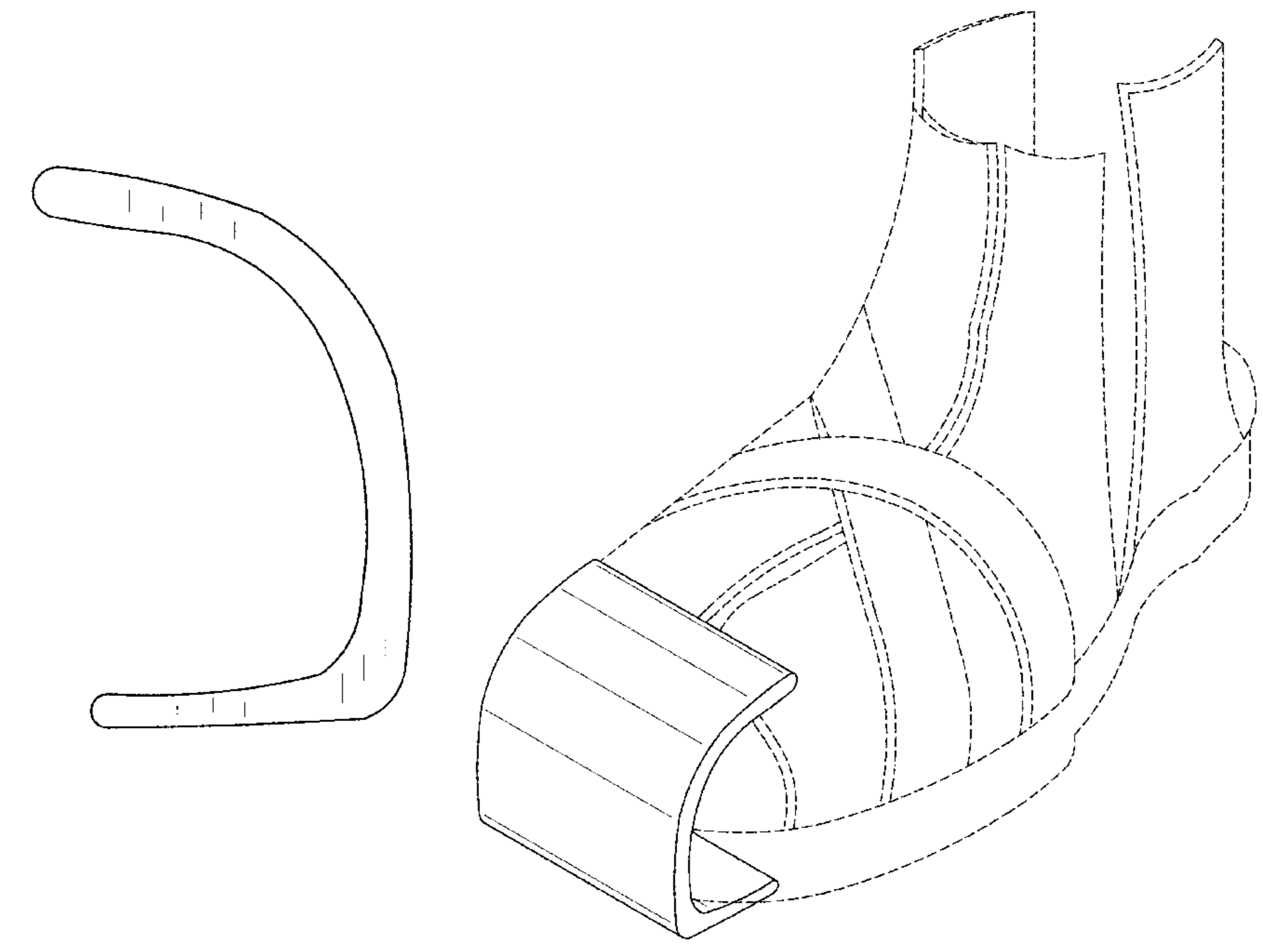

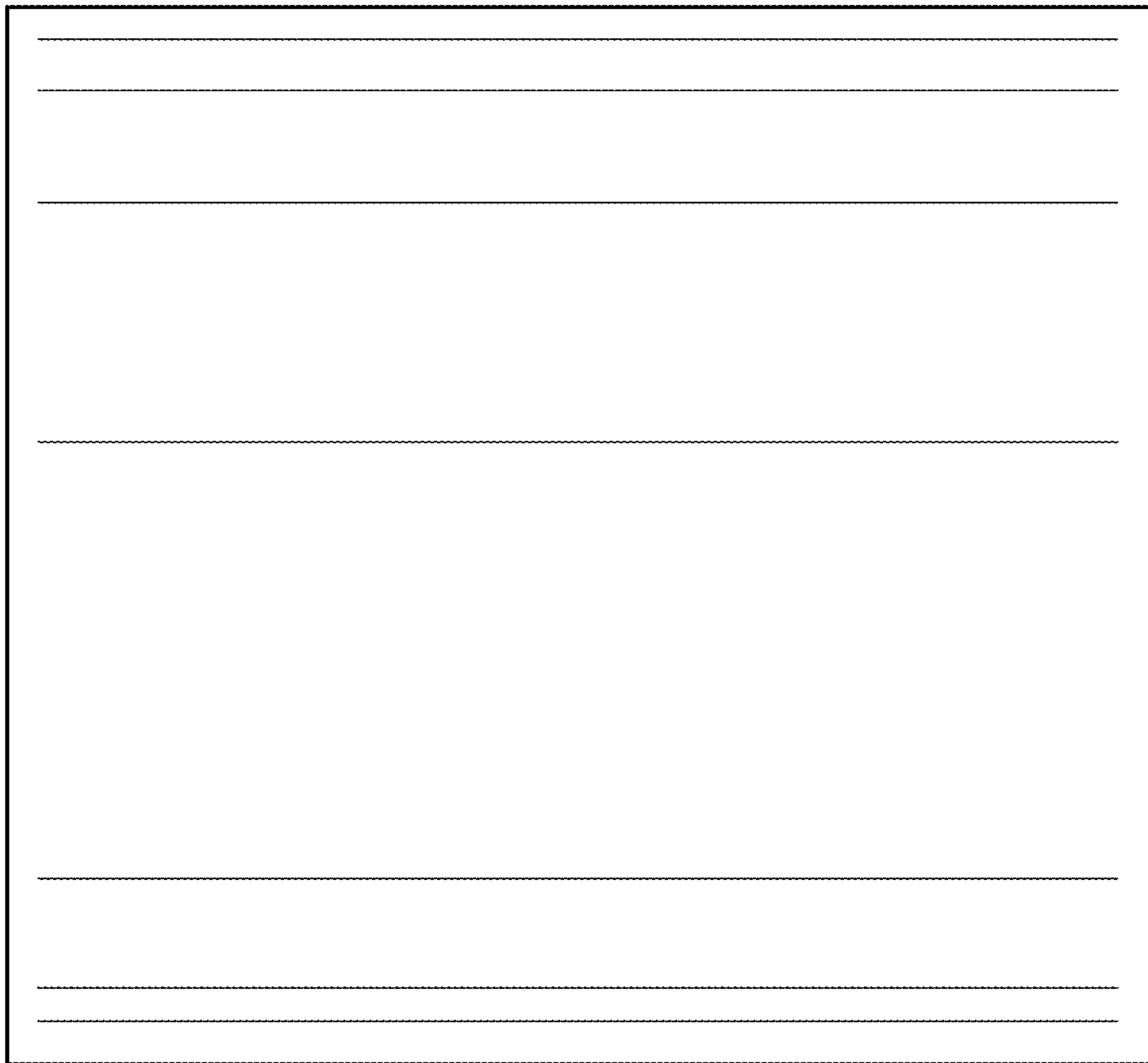

FIG. 1

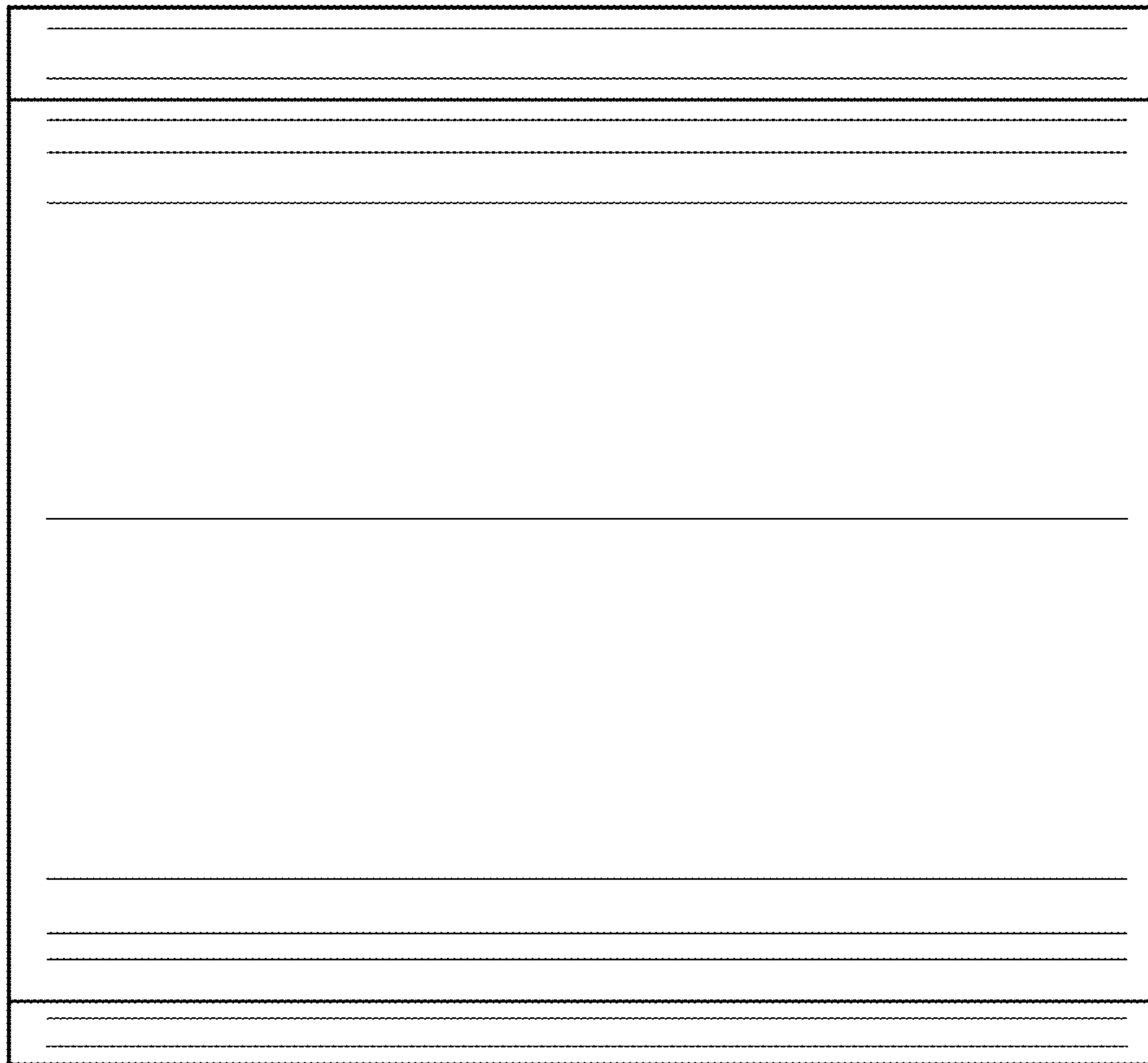

FIG. 2

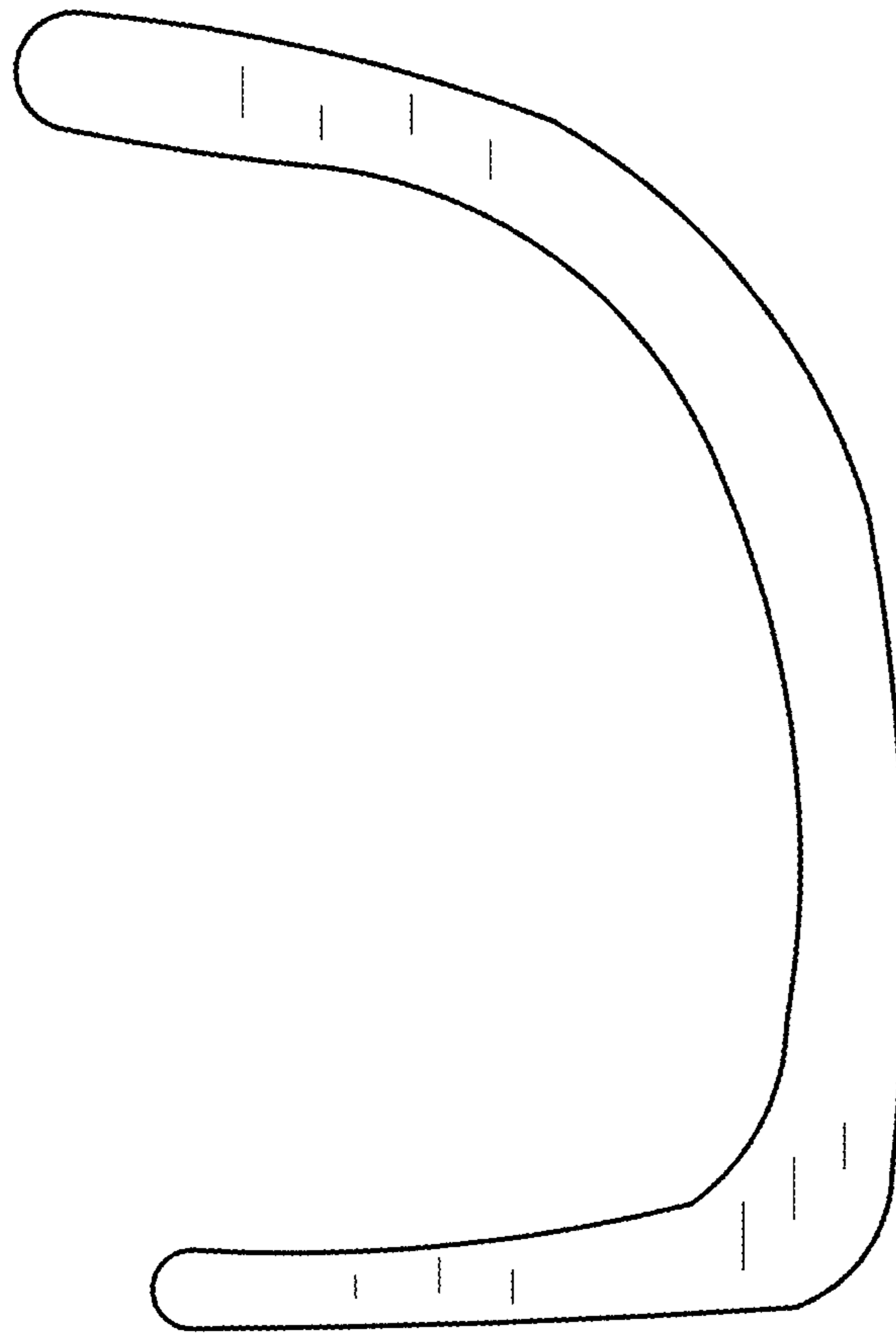

FIG. 3

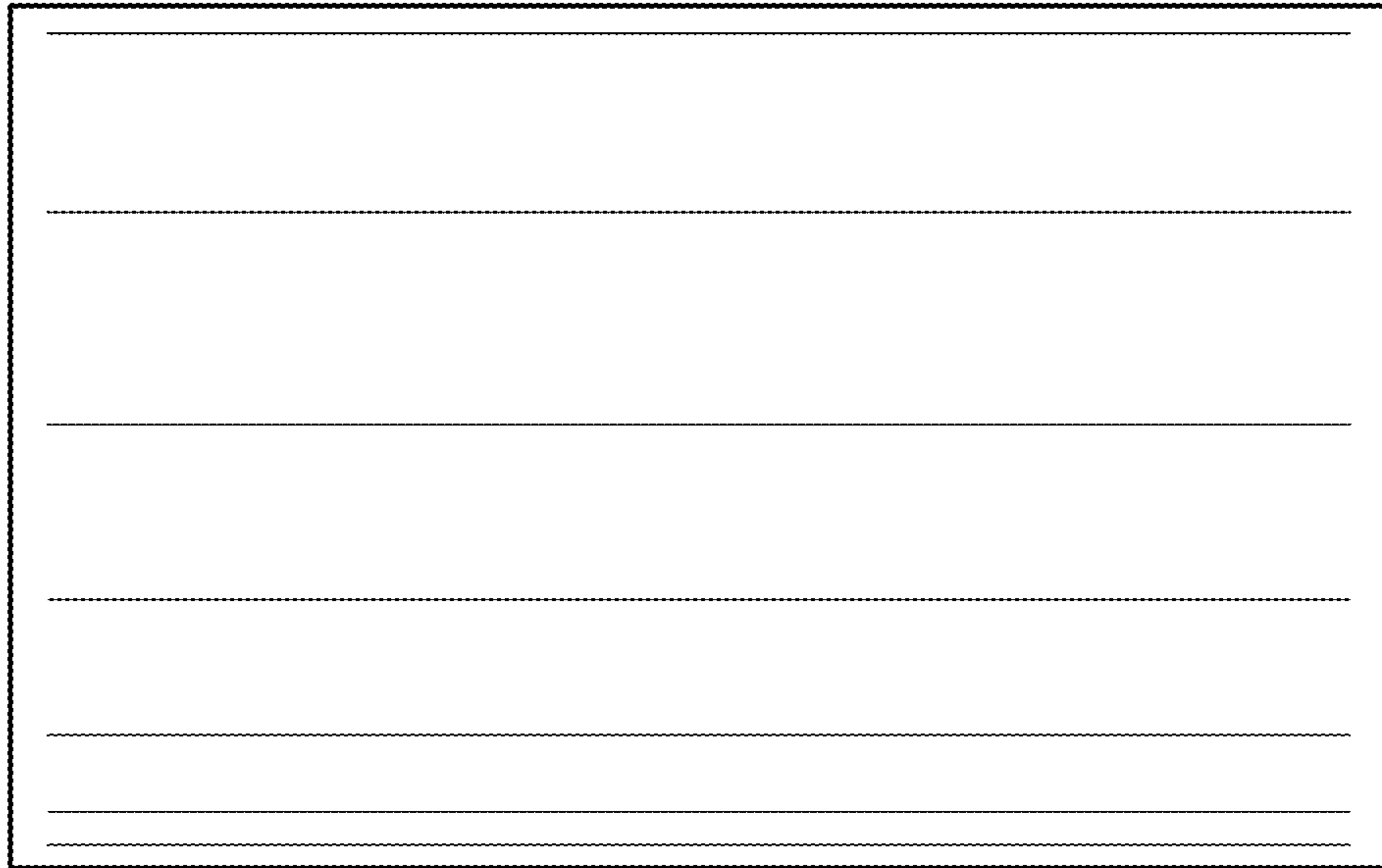

FIG. 4

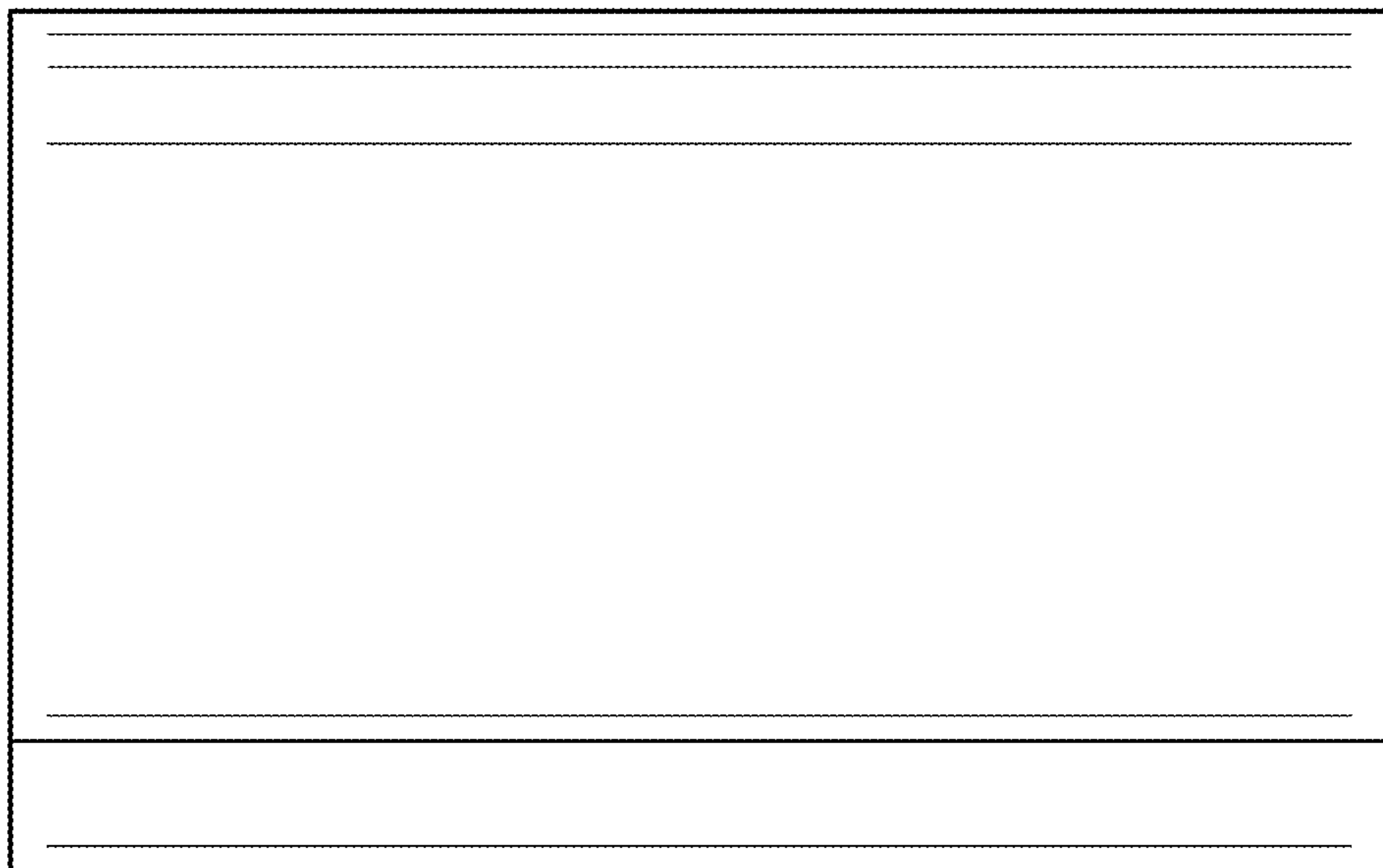

FIG. 5

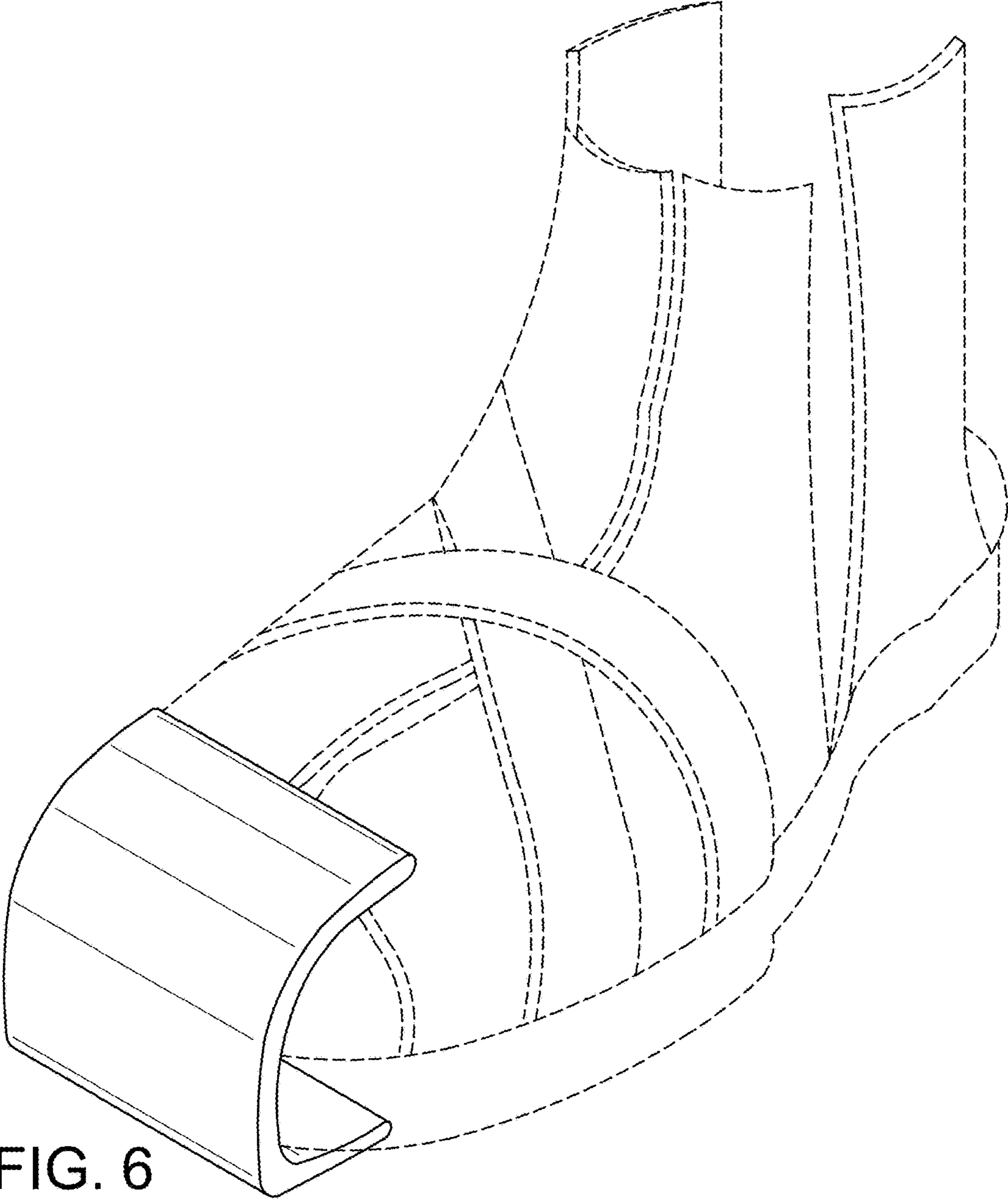

FIG. 6