

US00D793660S

(12) **United States Design Patent** (10) **Patent No.:** **US D793,660 S**
Bushby et al. (45) **Date of Patent:** **** Aug. 8, 2017**

(54) **SLEEVED PARTIAL UNDERSHIRT GARMENT**

(71) Applicant: **SLEEVEIT LLC**, Houston, TX (US)

(72) Inventors: **Donald P. Bushby**, Houston, TX (US);
Josefina Perez Pacaon, Houston, TX (US)

(73) Assignee: **SLEEVEIT LLC**, Houston, TX (US)

(**) Term: **14 Years**

(21) Appl. No.: **29/507,934**

(22) Filed: **Oct. 31, 2014**

(51) **LOC (10) Cl.** **02-02**

(52) **U.S. Cl.**
USPC **D2/717**

(58) **Field of Classification Search**
USPC D2/700, 701, 717, 731, 749-751, 755,
D2/501, 840, 841, 847
CPC A41D 1/22; A41D 3/00; A41D 15/007;
A41D 1/00; A41D 1/04
See application file for complete search history.

(56) **References Cited**

U.S. PATENT DOCUMENTS

719,650 A	2/1903	Davis	
807,628 A	12/1905	Marks	
1,117,077 A	11/1914	Mooney	
1,285,917 A	11/1918	Bradley et al.	
2,045,157 A	6/1936	Robert	
2,121,204 A	6/1938	Langworthy	
2,150,069 A	3/1939	Koleno	
2,237,368 A	4/1941	Seitzman et al.	
2,675,556 A *	4/1954	Collier	A41D 1/04 2/108
3,099,013 A	7/1963	Thorpe	
D214,356 S *	6/1969	Jarrett	2/115
3,911,497 A	10/1975	Lewis, Jr. et al.	
4,016,027 A	4/1977	Kintanar	

4,068,316 A	1/1978	Haywood
4,229,833 A	10/1980	Cox et al.
4,554,682 A	11/1985	Hillquist
4,570,267 A	2/1986	Appel
4,601,066 A	7/1986	Campbell
4,700,407 A	10/1987	Mattila
4,706,304 A	11/1987	Jones
4,771,518 A	9/1988	Lapointe et al.

(Continued)

OTHER PUBLICATIONS

Bushby et al.; U.S. Appl. No. 14/530,158 entitled "Sleeved Partial Undergarment and Methods of Use," filed Oct. 31, 2014.

(Continued)

Primary Examiner — Holly Baynham

Assistant Examiner — Rashida C Walshon

(74) *Attorney, Agent, or Firm* — Russell Ng PLLC; Brian F. Russell

(57) **CLAIM**

The ornamental design of a sleeved partial undershirt garment, substantially as shown and described.

DESCRIPTION

FIG. 1 is a front perspective (elevational) view of a sleeved partial undershirt garment in accordance with the present invention.

FIG. 2 is a front view of the garment of FIG. 1.

FIG. 3 is a back view thereof.

FIG. 4 is a right side view thereof.

FIG. 5 is a left side view thereof.

FIG. 6 is a top view thereof; and,

FIG. 7 is a bottom view thereof.

The double row of dashed lines represent unclaimed stitching. The dash-dot-dash lines immediately adjacent the solid line portions of the design form the boundary and are not part of the claimed design.

1 Claim, 5 Drawing Sheets

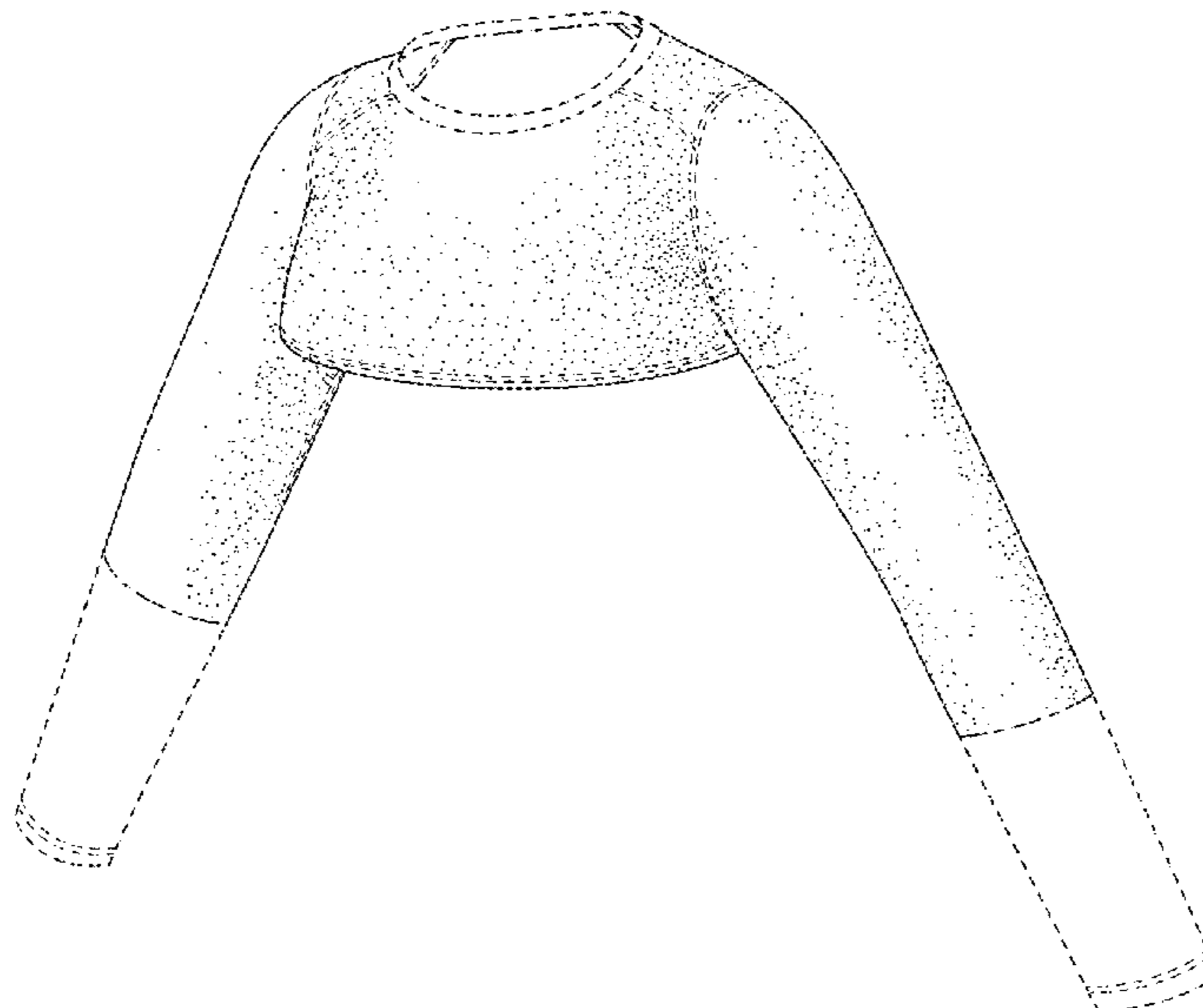

(56)

References Cited

U.S. PATENT DOCUMENTS

D299,562 S 1/1989 Lee
 4,977,622 A 12/1990 Schley
 4,985,934 A 1/1991 Perry
 5,187,813 A 2/1993 Klein
 5,375,261 A 12/1994 Lipke
 5,542,121 A 8/1996 Lahausssois et al.
 5,628,064 A * 5/1997 Chung A41D 15/00
 2/119
 5,682,616 A 11/1997 Pisano
 5,720,044 A 2/1998 Robinson
 5,734,992 A 4/1998 Ross
 5,761,746 A 6/1998 Brown
 5,918,315 A 7/1999 Trachtenberg
 5,974,586 A 11/1999 Reinoso
 6,052,824 A 4/2000 May
 D431,343 S 10/2000 Sampson
 D442,765 S 5/2001 Newman
 D463,092 S 9/2002 Perez
 6,813,779 B1 11/2004 Williams
 7,028,342 B1 4/2006 Nordstrom et al.
 7,429,206 B2 9/2008 Perry
 7,818,817 B1 10/2010 Owens et al.
 D639,024 S * 6/2011 Benderradji D2/501
 D646,869 S 10/2011 Greenblat
 8,075,366 B1 12/2011 Jaksic et al.
 8,082,597 B2 12/2011 Young
 D663,925 S * 7/2012 Greenblat D2/750
 D675,811 S * 2/2013 Stevens D2/847
 8,365,313 B2 2/2013 Greenblat
 8,371,901 B2 2/2013 Frey
 D677,448 S 3/2013 Bazile

D680,302 S * 4/2013 Greenblat D2/840
 D680,303 S 4/2013 Greenblat
 D683,929 S 6/2013 Bryan
 D695,999 S * 12/2013 Colburn D2/755
 8,650,662 B2 2/2014 Decker
 D703,923 S * 5/2014 Marshall D2/840
 2004/0064869 A1 4/2004 Deadwyler
 2004/0199976 A1 * 10/2004 Hunt A41D 1/22
 2/93
 2004/0221360 A1 11/2004 Wood et al.
 2008/0047044 A1 2/2008 Jones
 2009/0013445 A1 * 1/2009 Martin A41D 27/10
 2/93
 2010/0017937 A1 1/2010 Birmingham
 2012/0324615 A1 12/2012 Heimann
 2014/0075638 A1 3/2014 Larkin
 2014/0115754 A1 5/2014 Bloomfield

OTHER PUBLICATIONS

Bushby et al.; Design U.S. Appl. No. 29/507,924 entitled "Sleeved Partial Undershirt Garment," filed Oct. 31, 2014.
 Pacaon et al.; Design U.S. Appl. No. 29/507,941 entitled "Open Front Sleeved Partial Undershirt Garment," filed Oct. 31, 2014.
 Bushby et al.; Design U.S. Appl. No. 29/507,946 entitled "Hooded and Sleeved Partial Undershirt Garment," filed Oct. 31, 2014.
 Bushby et al.; Design U.S. Appl. No. 29/507,951 entitled "Collared and Sleeved Partial Undershirt Garment," filed Oct. 31, 2014.
 zappos.com; Pearl Izumi W Fly Shrug (item information); 2 pgs.; retrieved Dec. 9, 2014 from the internet (http://www.zappos.com/pearl-izumi-w-fly-shrug-black?ef_id=VCDn6QAAALpN6F9s:20140923033204:s).

* cited by examiner

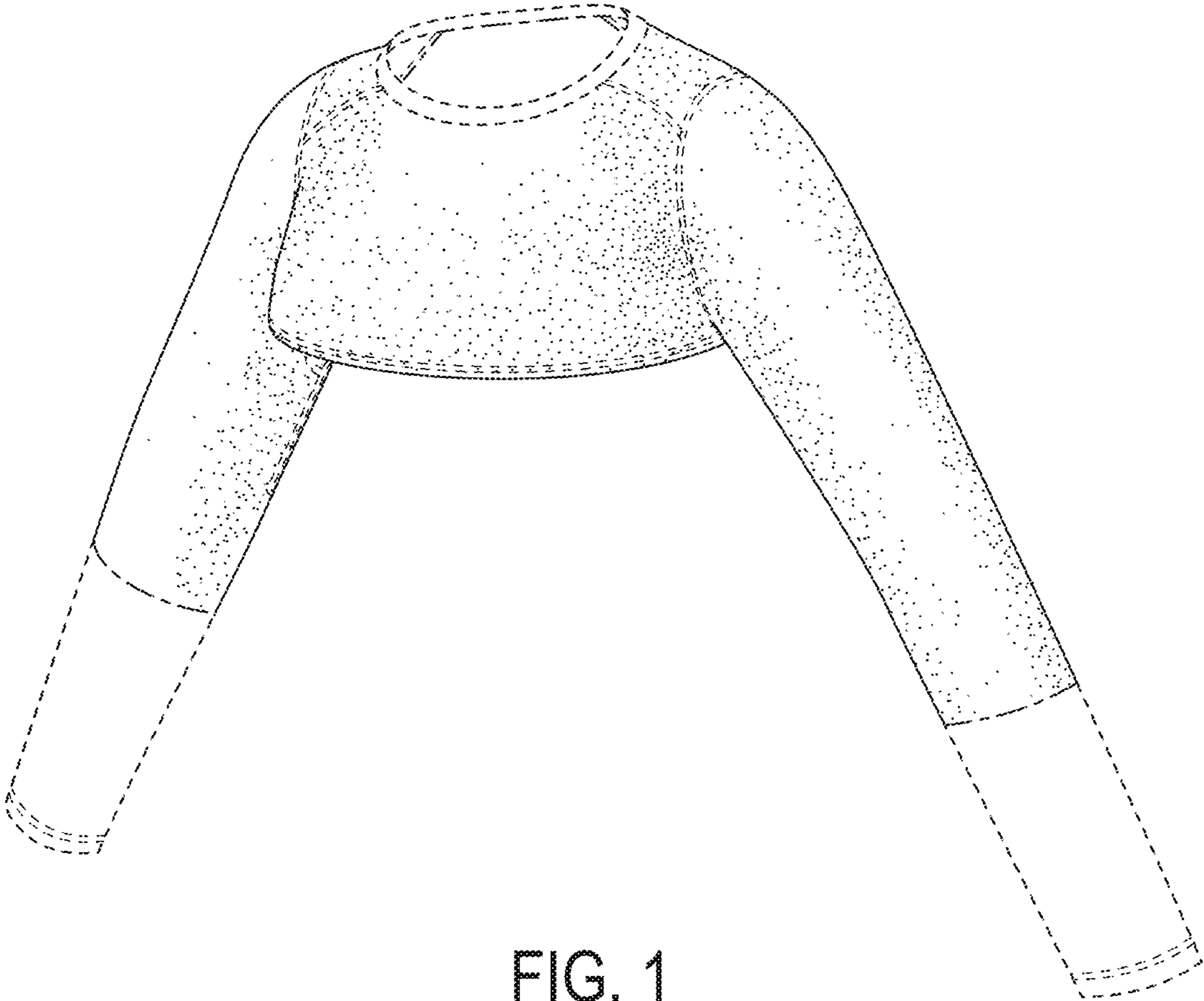

FIG. 1

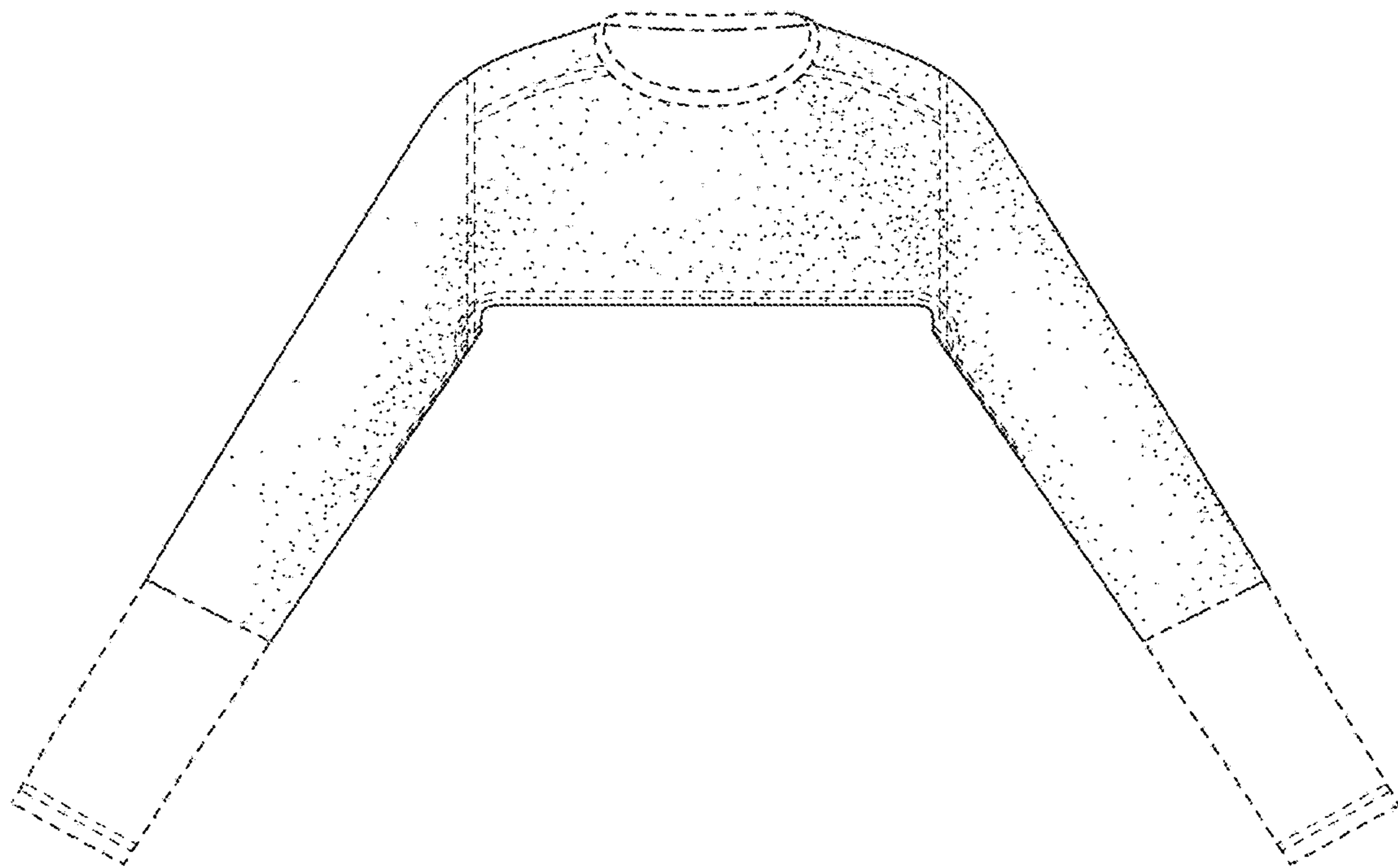

FIG. 2

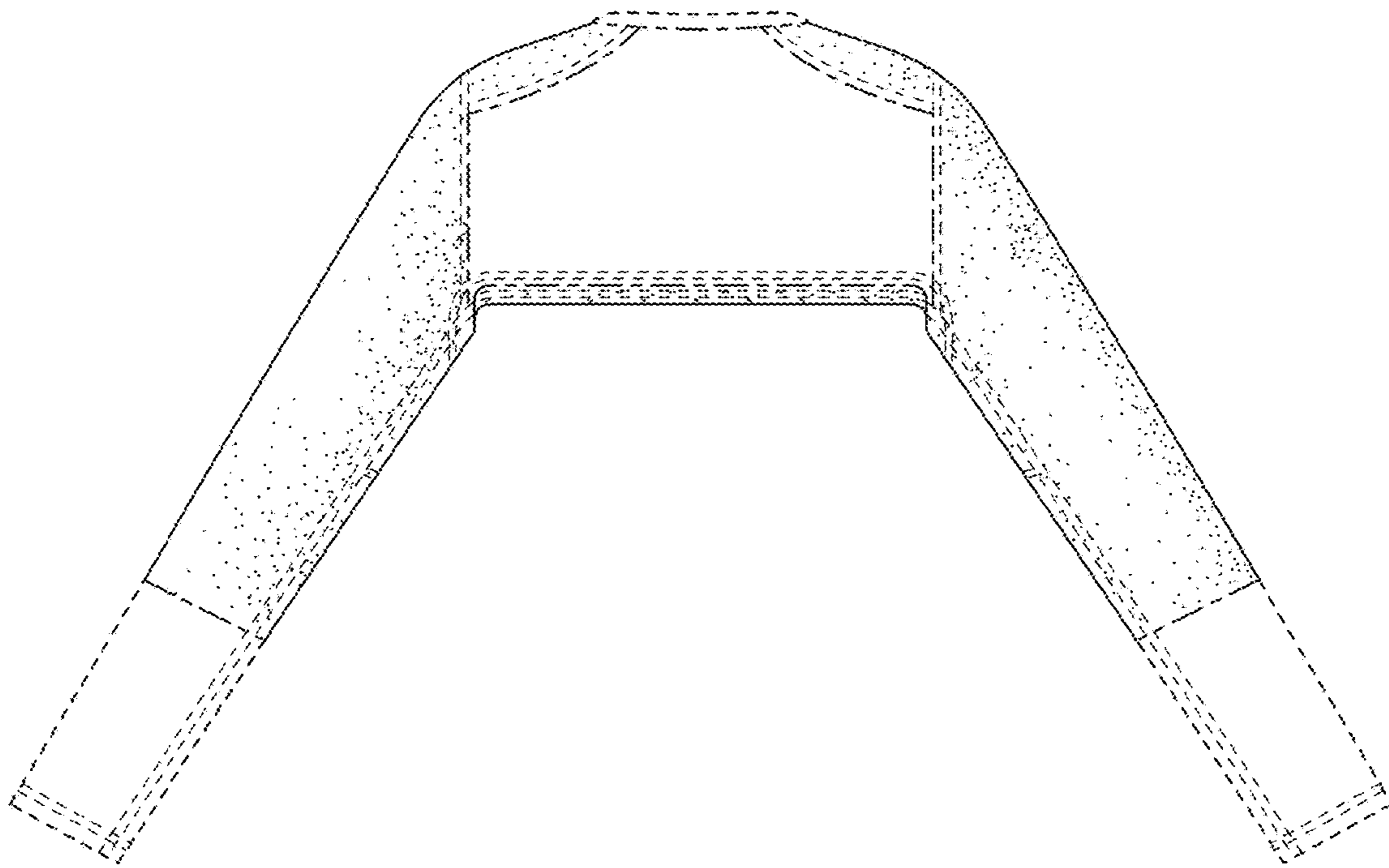

FIG. 3

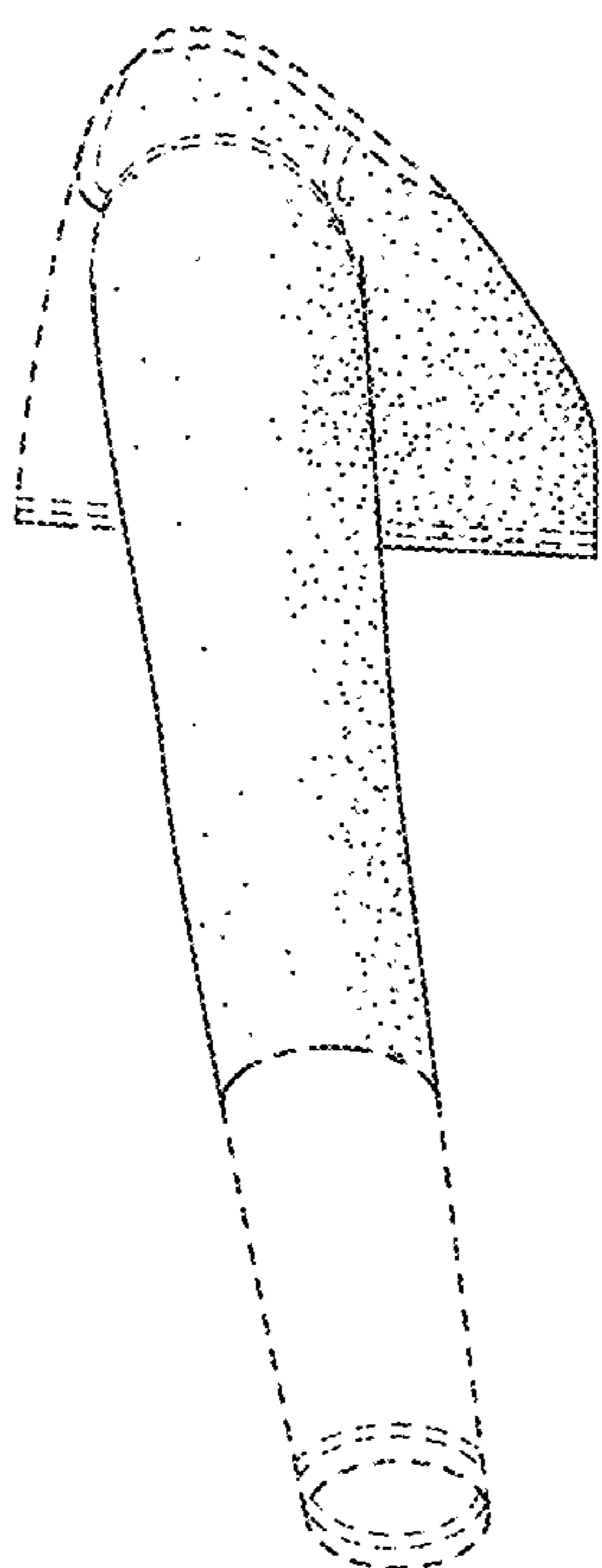

FIG. 4

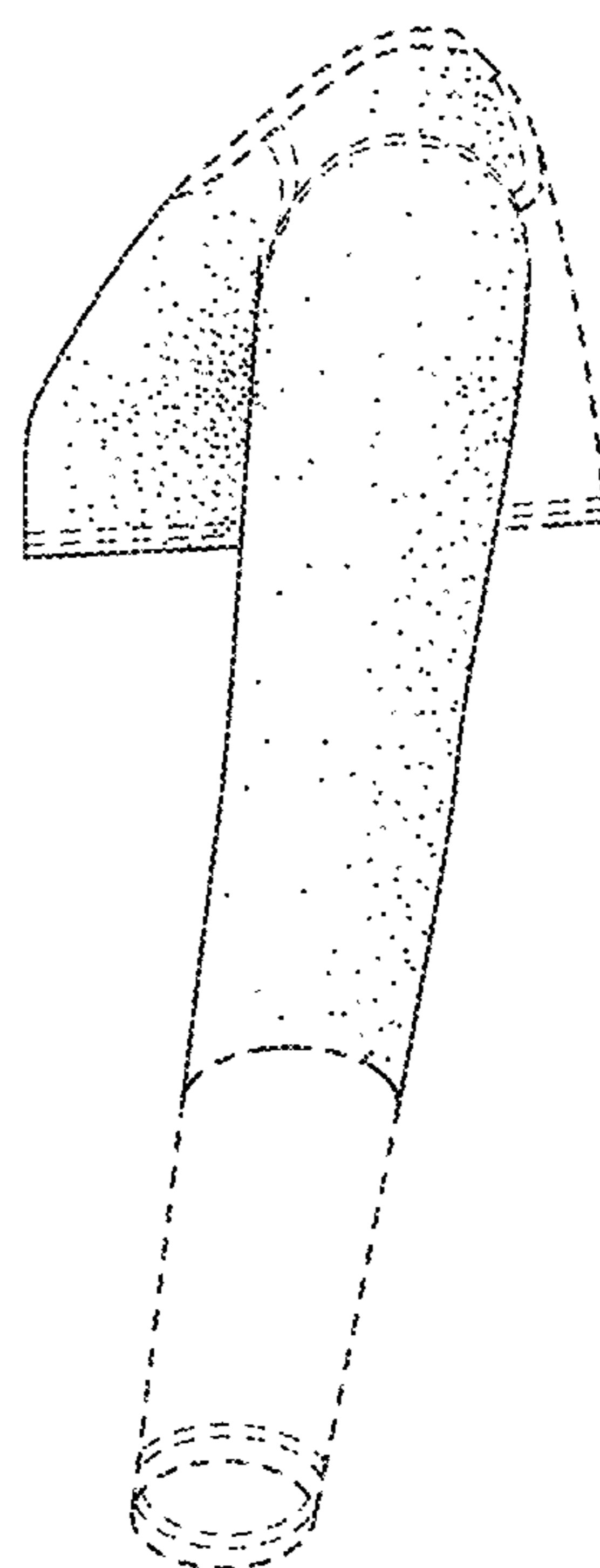

FIG. 5

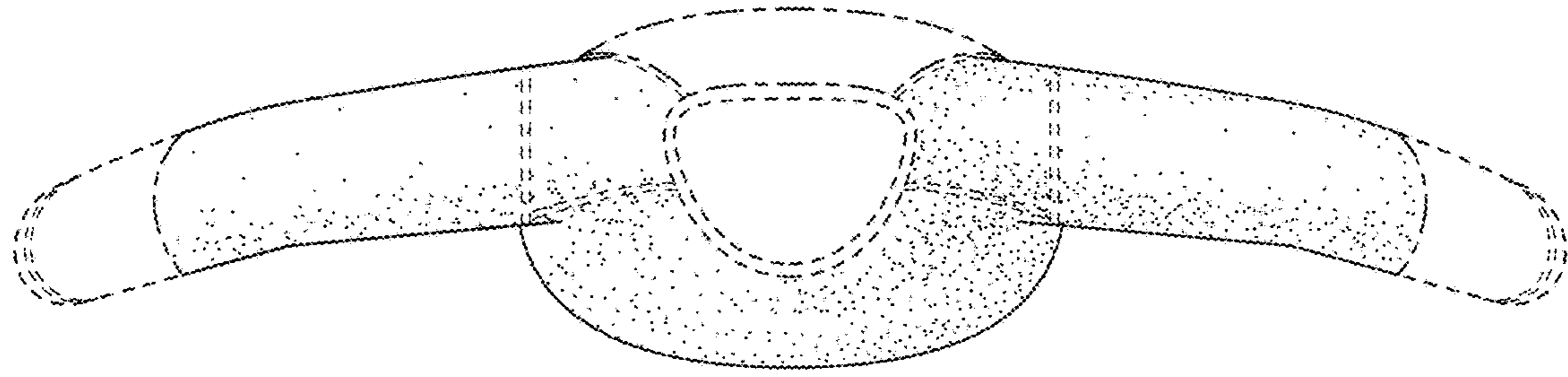

FIG. 6

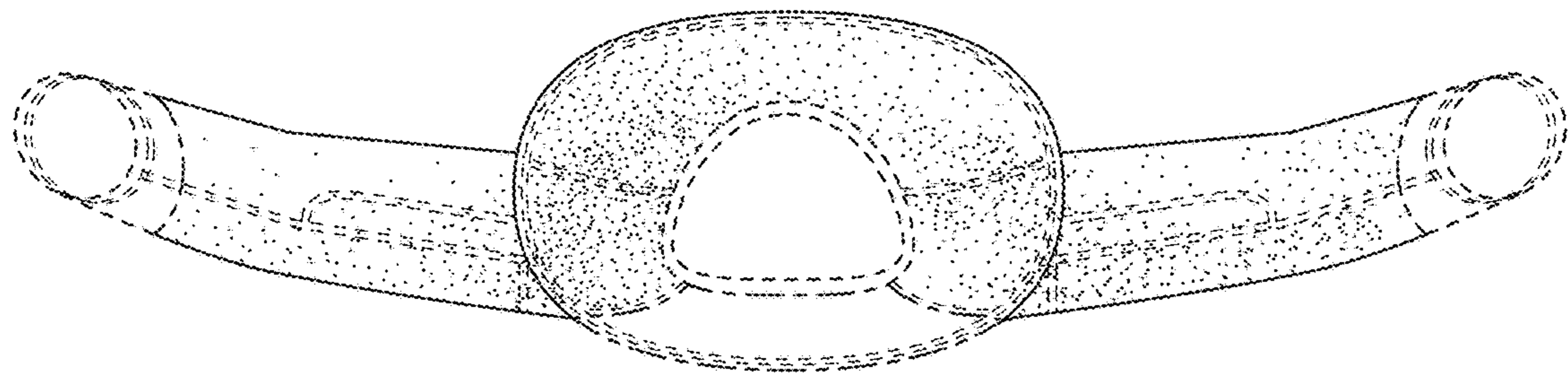

FIG. 7