

US00D793639S

(12) **United States Design Patent** (10) **Patent No.:** **US D793,639 S**
Schuller et al. (45) **Date of Patent:** **** Aug. 1, 2017**

(54) **CLEANING DEVICE**
(71) Applicant: **The Procter & Gamble Company**,
Cincinnati, OH (US)
(72) Inventors: **David William Schuller**, Lebanon, OH
(US); **Rainer Bernhard Teufel**,
Worthington, OH (US); **Igor Ivanovich**
Zemskov, Dublin, OH (US); **Stephen**
Adam Hughett, Westerville, OH (US)
(73) Assignee: **The Procter & Gamble Company**,
Cincinnati, OH (US)
(**) Term: **14 Years**
(21) Appl. No.: **29/526,621**
(22) Filed: **May 12, 2015**
(51) **LOC (10) Cl.** **04-01**
(52) **U.S. Cl.**
USPC **D32/45**
(58) **Field of Classification Search**
USPC D32/40, 49-53, 71-72
CPC A47L 13/12; A47L 13/16; A47L 13/20;
A47L 13/24; A47L 13/144; A47L 13/146;
A47L 13/10; B24D 13/045
See application file for complete search history.

8,166,597 B2 * 5/2012 Levitt A47L 13/12
15/118
D704,910 S * 5/2014 Hughes D32/40
D720,906 S * 1/2015 Baldwin D32/50
8,927,480 B2 * 1/2015 Williams A47L 13/17
15/228

(Continued)

FOREIGN PATENT DOCUMENTS

CN 303324217 * 8/2015
JP D1334735 * 6/2008

OTHER PUBLICATIONS

Amazon.com: Dirt Devil PD11000 Quick Clean Spray Mop with Swipes Microfiber Scrubbing Pad, review date Sep. 23, 2015, https://www.amazon.com/Dirt-Devil-PD11000-Microfiber-Scrubbing/dp/B00IA8LVYI/ref=cm_cr_ar_p_d_product_top?ie=UTF8, [site visited Sep. 21, 2016 6:21:09 PM].*

(Continued)

Primary Examiner — John Windmuller
Assistant Examiner — John R Yeh
(74) *Attorney, Agent, or Firm* — Larry L. Huston

(57) **CLAIM**

The ornamental design for a cleaning device, as shown and described.

DESCRIPTION

FIG. 1 is a perspective view of a first embodiment of a cleaning device;
FIG. 2 is a back view of the first embodiment;
FIG. 3 is a right side view of the first embodiment;
FIG. 4 is a front view of the first embodiment;
FIG. 5 is a left side view of the first embodiment;
FIG. 6 is a top view of the first embodiment; and,
FIG. 7 is a bottom view of the first embodiment.
The broken lines in the figures represent portions of the cleaning device that form no part of the claimed design.

1 Claim, 6 Drawing Sheets

(56) **References Cited**

U.S. PATENT DOCUMENTS

D391,715 S * 3/1998 Irwin D32/50
D481,184 S * 10/2003 Clare D32/50
D487,174 S * 2/2004 Colman D32/45
D506,050 S * 6/2005 Lalanne D32/45
D554,815 S * 11/2007 Harper D32/40
D574,565 S * 8/2008 Harper D32/50
D581,618 S * 11/2008 Soller D32/50
D585,612 S * 1/2009 Soller D32/40
D591,921 S * 5/2009 Rosenzweig D32/45
D607,168 S * 12/2009 Libman D32/45
D644,386 S * 8/2011 Tawara D32/51
D661,034 S * 5/2012 Ediger D32/45

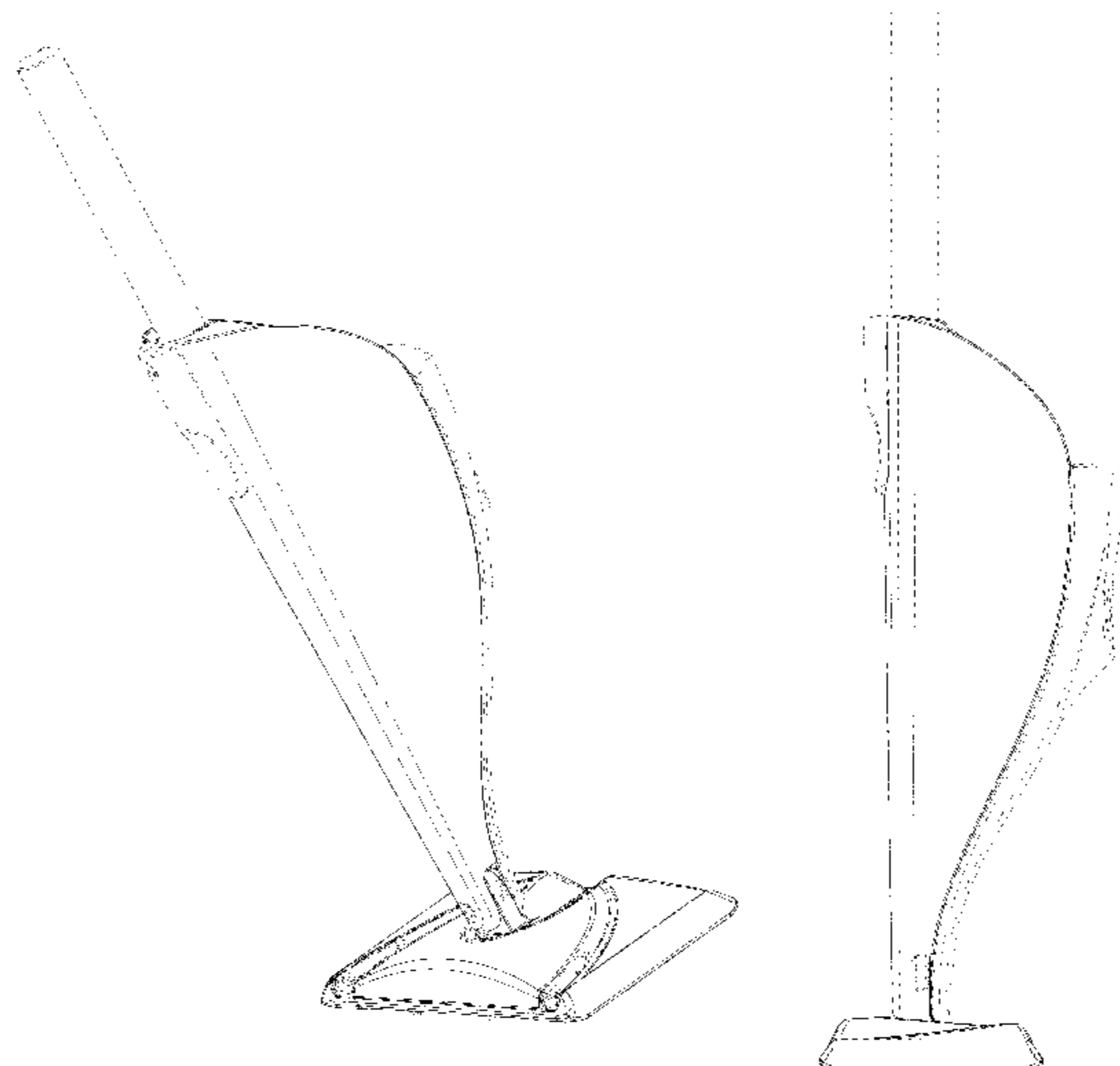

(56)

References Cited

U.S. PATENT DOCUMENTS

D723,233 S * 2/2015 Gidwell D32/50
D742,608 S * 11/2015 Chang D32/40
9,179,816 B2 * 11/2015 Kaminer A47L 13/20
D759,329 S * 6/2016 Colangelo D32/50
9,420,932 B2 * 8/2016 Hansen A47L 11/34
D766,528 S * 9/2016 Choi D32/50
2005/0022843 A1 * 2/2005 Policicchio A47L 13/20
134/6
2007/0256266 A1 * 11/2007 Michelson A47L 13/20
15/228

OTHER PUBLICATIONS

Amazon.com: Swiffer WetJet Floor Spray Mop Starter Kit, oldest review Jun. 28, 2015, https://www.amazon.com/Swiffer-WetJet-Floor-Spray-Starter/dp/B00MNX7J6K/ref=cm_cr_arp_d_product_top?ie=UTF8, [site visited Sep. 21, 2016 8:03:06 PM].*

Amazon.com—Swiffer® WetJet® Mop Starter Kit, review date Sep. 20, 2016, https://www.amazon.com/Swiffer®-WetJet®-Starter-WetJet-pads/dp/B01IDT0S5G/ref=sr_1_100?ie=UTF8&qid=1474496703&sr=8-100&keywords=flexible+mop, [site visited Sep. 21, 2016 6:26:46 PM].*

* cited by examiner

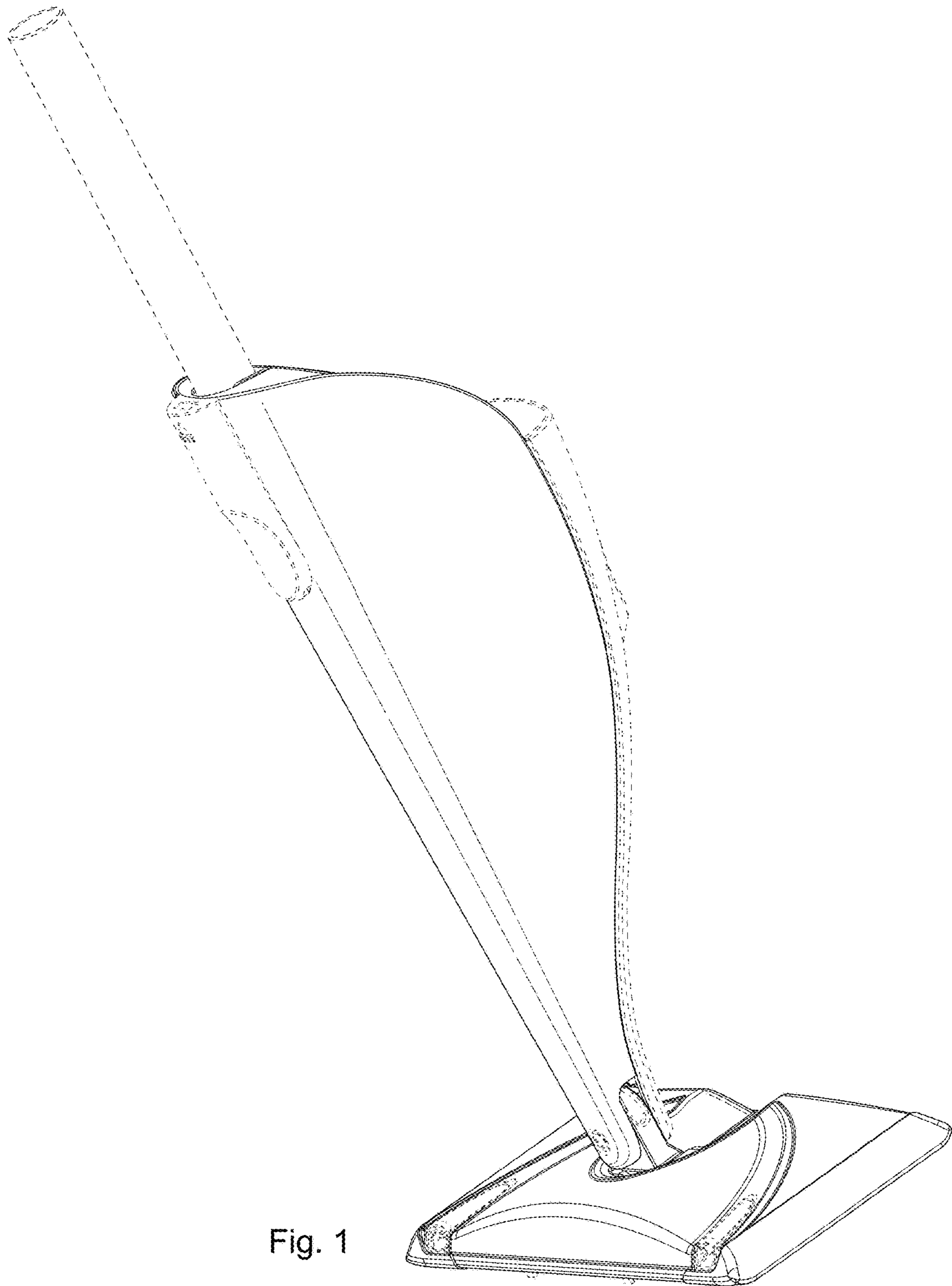

Fig. 1

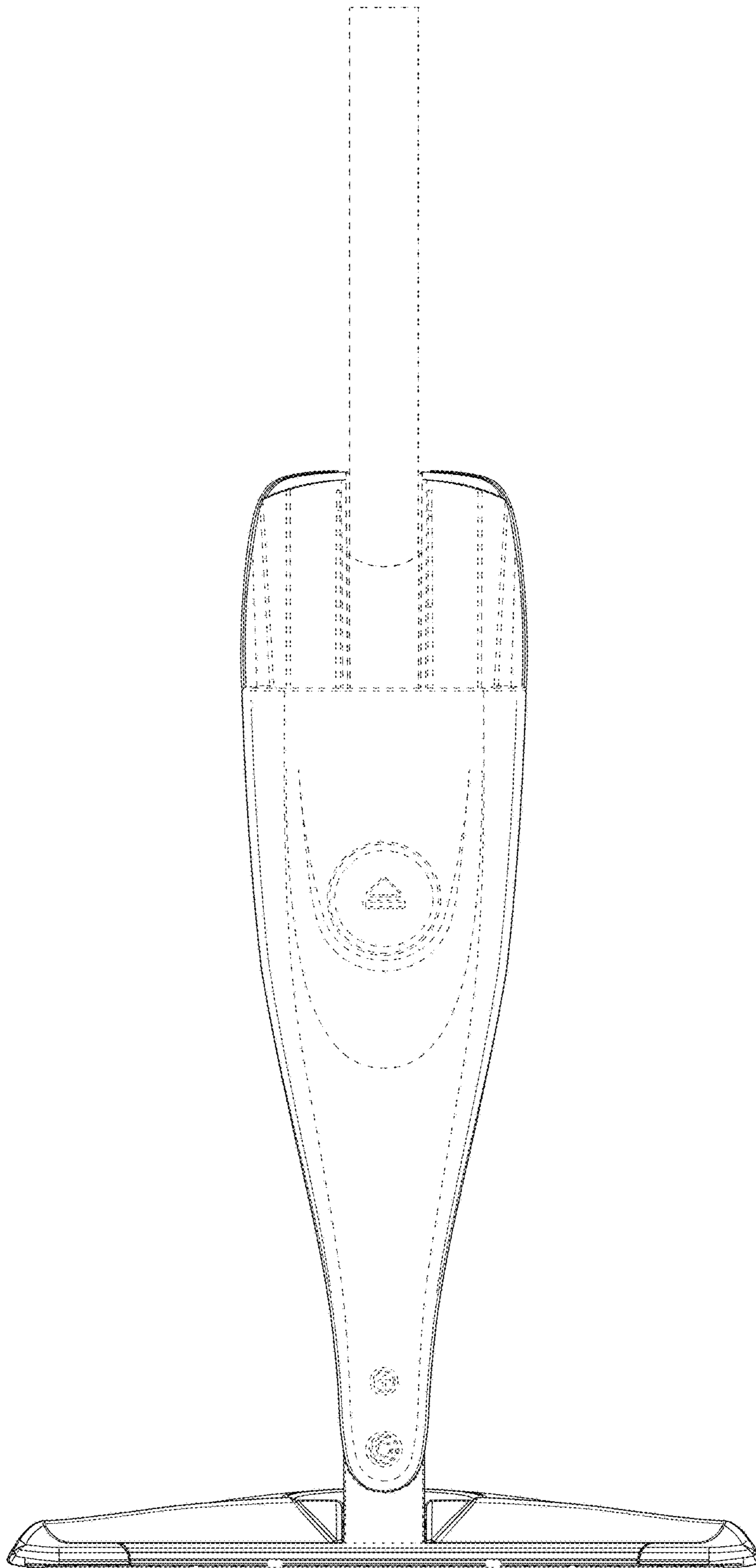

Fig. 2

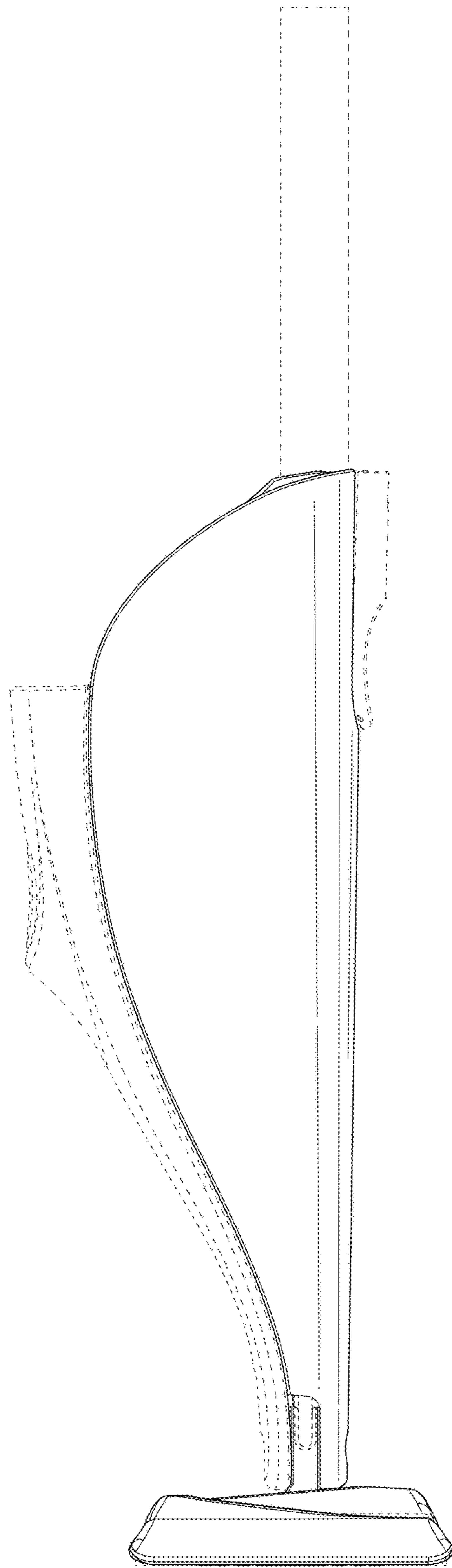

Fig. 3

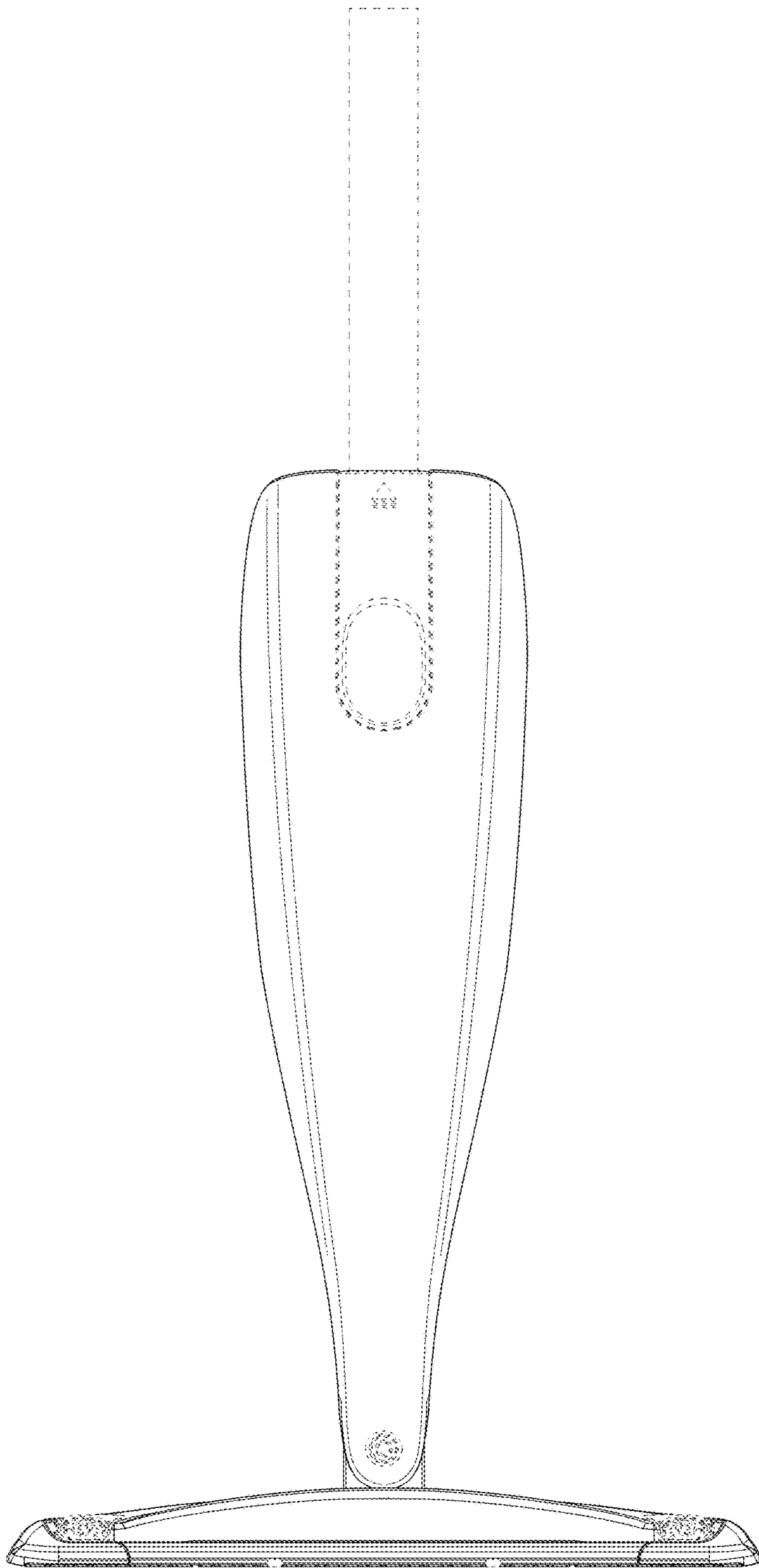

Fig. 4

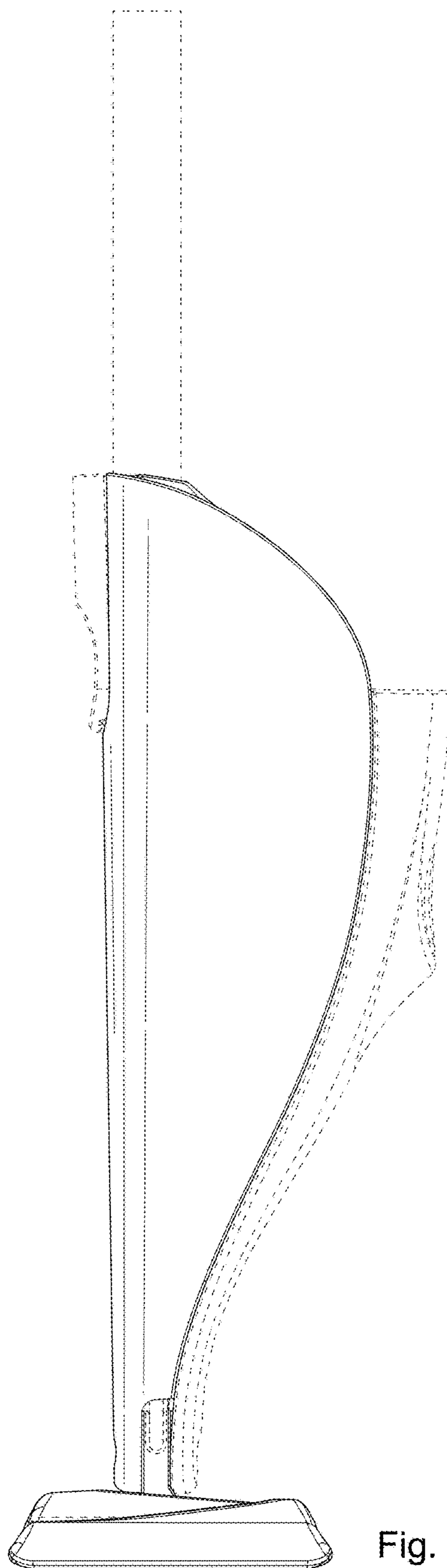

Fig. 5

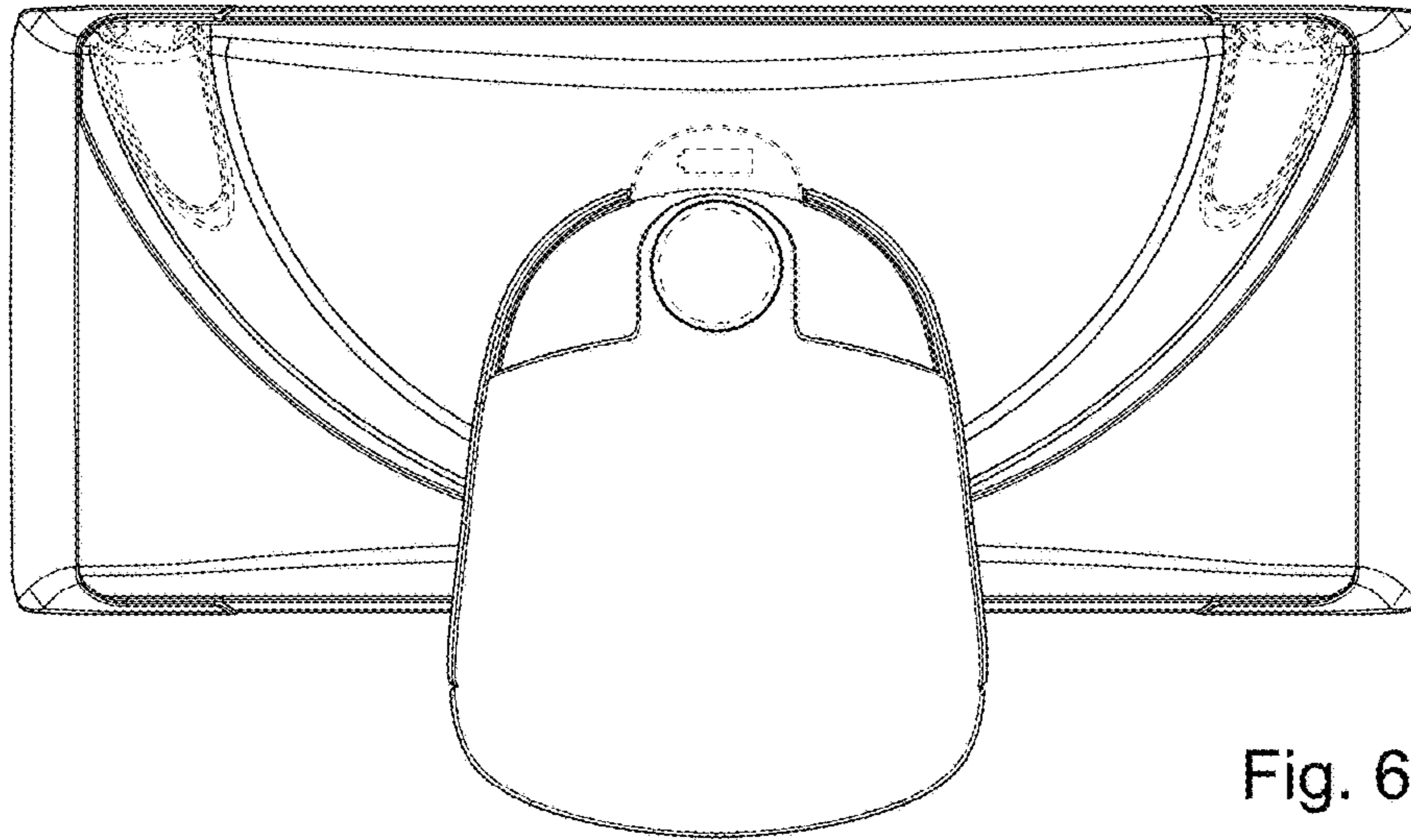

Fig. 6

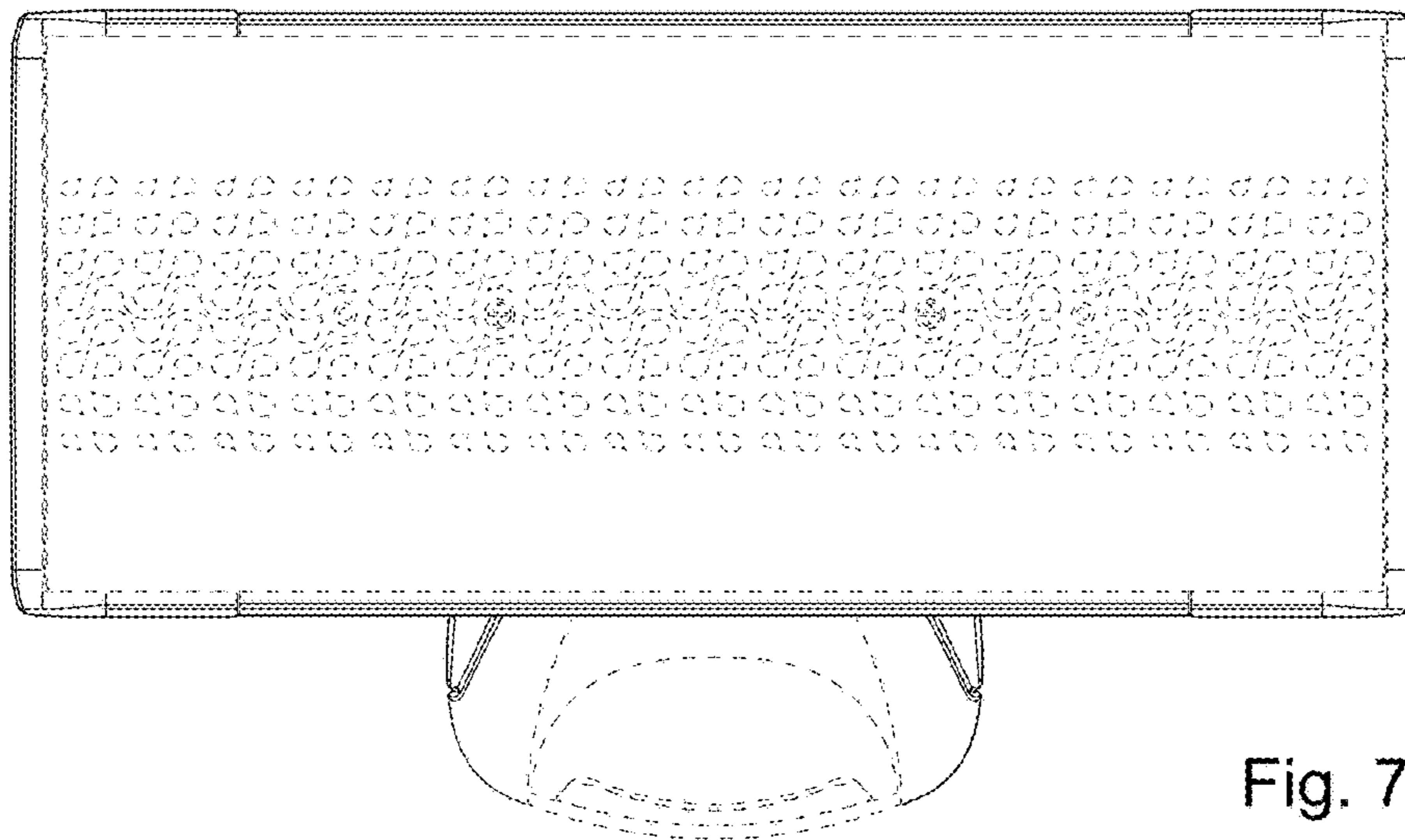

Fig. 7