



US00D793622S

(12) **United States Design Patent** (10) **Patent No.:** **US D793,622 S**  
**Villarreal et al.** (45) **Date of Patent:** **\*\* Aug. 1, 2017**

(54) **STYLING COMB**

(71) Applicants: **Mireya Villarreal**, Streamwood, IL  
(US); **Paolo Aristodemo**, Streamwood,  
IL (US)

(72) Inventors: **Mireya Villarreal**, Streamwood, IL  
(US); **Paolo Aristodemo**, Streamwood,  
IL (US)

(73) Assignee: **SELVAGGIA, INC.**, Streamwood, IL  
(US)

(\*\*) Term: **15 Years**

(21) Appl. No.: **29/555,748**

(22) Filed: **Feb. 24, 2016**

(51) **LOC (10) Cl.** ..... **28-03**

(52) **U.S. Cl.**  
USPC ..... **D28/21**

(58) **Field of Classification Search**

USPC ..... D4/104, 114, 125, 132, 133, 136;  
D28/10, 13, 15, 18, 21–22, 27–33, 35,  
D28/39–43; D1/107, 111, 199;  
D30/158–159, 162  
CPC ..... A46B 9/023; A46B 9/02; A46B 9/028;  
A46B 1/00; A46B 3/00; A46B 5/00;  
A46B 5/0054; A46B 5/021; A46B 7/00;  
A46B 9/021; A46B 3/023; A46B 9/025;  
A46B 9/026; A46B 9/04; A46B 15/003;  
A46B 15/0059; A46B 2200/102; A46B  
2200/104; B29L 2021/00; B29L  
2021/005; A45D 1/10; A45D 1/18; A45D  
2/001; A45D 2/002; A45D 2/2471; A45D  
8/12; A45D 19/0008; A45D 2019/0041;  
A45D 20/12; A45D 20/122; A45D  
2020/128; A45D 20/48; A45D 20/52;  
A45D 24/00; A45D 24/02; A45D 24/22

See application file for complete search history.

(56) **References Cited**

U.S. PATENT DOCUMENTS

D126,242 S *	4/1941	Kahn	.....	D28/30
D133,383 S *	8/1942	Kahn	.....	D28/30
D203,734 S *	2/1966	Lutz	.....	132/149
D212,659 S *	11/1968	Kress	.....	D28/30
3,749,105 A *	7/1973	Sestita	.....	A45D 24/02
				132/208
D261,815 S *	11/1981	Hustler	.....	D28/30
D275,329 S *	8/1984	Giuliano	.....	D28/30
D282,297 S *	1/1986	Harvey	.....	D28/30
4,654,921 A *	4/1987	Dinner	.....	A46B 5/02
				15/143.1
5,018,542 A *	5/1991	Lee	.....	A45D 19/02
				132/139
5,694,953 A *	12/1997	Stephan	.....	A45D 19/00
				132/160
D389,271 S *	1/1998	Celik	.....	D28/30
D415,595 S *	10/1999	O'Farrell	.....	D30/159
D425,666 S *	5/2000	Weinberg	.....	D28/10
6,523,547 B1 *	2/2003	Crocilla	.....	A45D 19/02
				132/139

(Continued)

*Primary Examiner* — Karen Kearney  
*Assistant Examiner* — Debra Callahan  
(74) *Attorney, Agent, or Firm* — Pauley Erickson &  
Kottis

(57) **CLAIM**

The ornamental design for a styling comb, as shown.

**DESCRIPTION**

FIG. 1 is a bottom left perspective view of the styling comb;  
and  
FIG. 2 is a right side elevational view thereof; and  
FIG. 3 is a left side elevational view thereof; and  
FIG. 4 is a front elevational view thereof; and  
FIG. 5 is a rear elevational view thereof; and  
FIG. 6 is a top plan view thereof; and,  
FIG. 7 is a bottom plan view thereof.

**1 Claim, 5 Drawing Sheets**

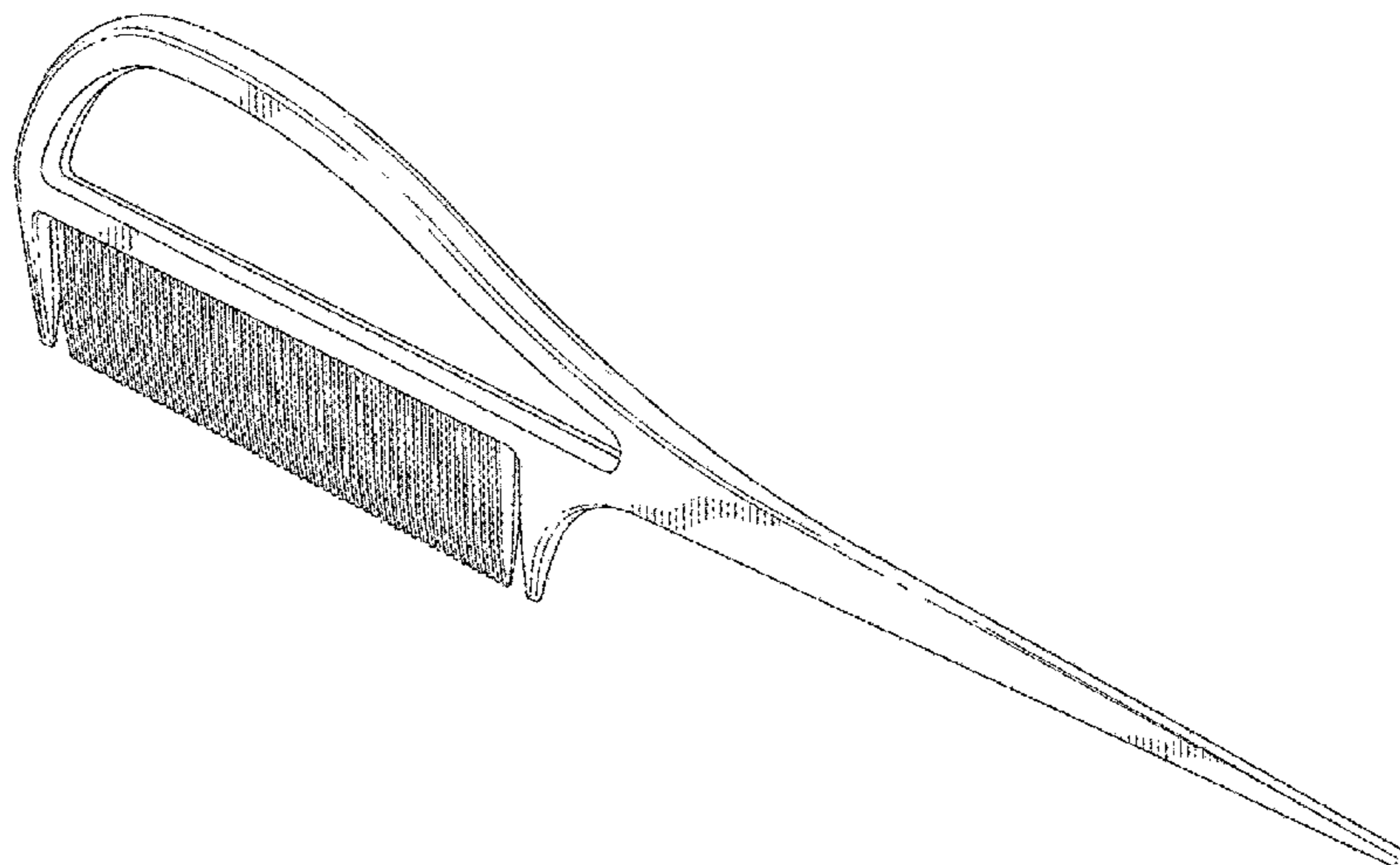

(56)

**References Cited**

U.S. PATENT DOCUMENTS

D471,320 S \* 3/2003 Kim ..... D28/30  
D490,983 S \* 6/2004 Tini ..... D4/104  
D527,843 S \* 9/2006 Bartsch ..... D28/7  
7,273,057 B1 \* 9/2007 Capaldo ..... A45D 24/00  
132/148  
D596,352 S \* 7/2009 Germano-Cataldo ..... D28/31  
D692,193 S \* 10/2013 Baars ..... D30/162  
D709,250 S \* 7/2014 Walker ..... D30/158  
D714,491 S \* 9/2014 Du ..... A45D 24/00  
D28/25  
D770,093 S \* 10/2016 Smith ..... D28/21  
2006/0243292 A1 \* 11/2006 Roger ..... A45D 24/22  
132/114  
2012/0192893 A1 \* 8/2012 Anderson ..... A45D 19/0008  
132/219

\* cited by examiner

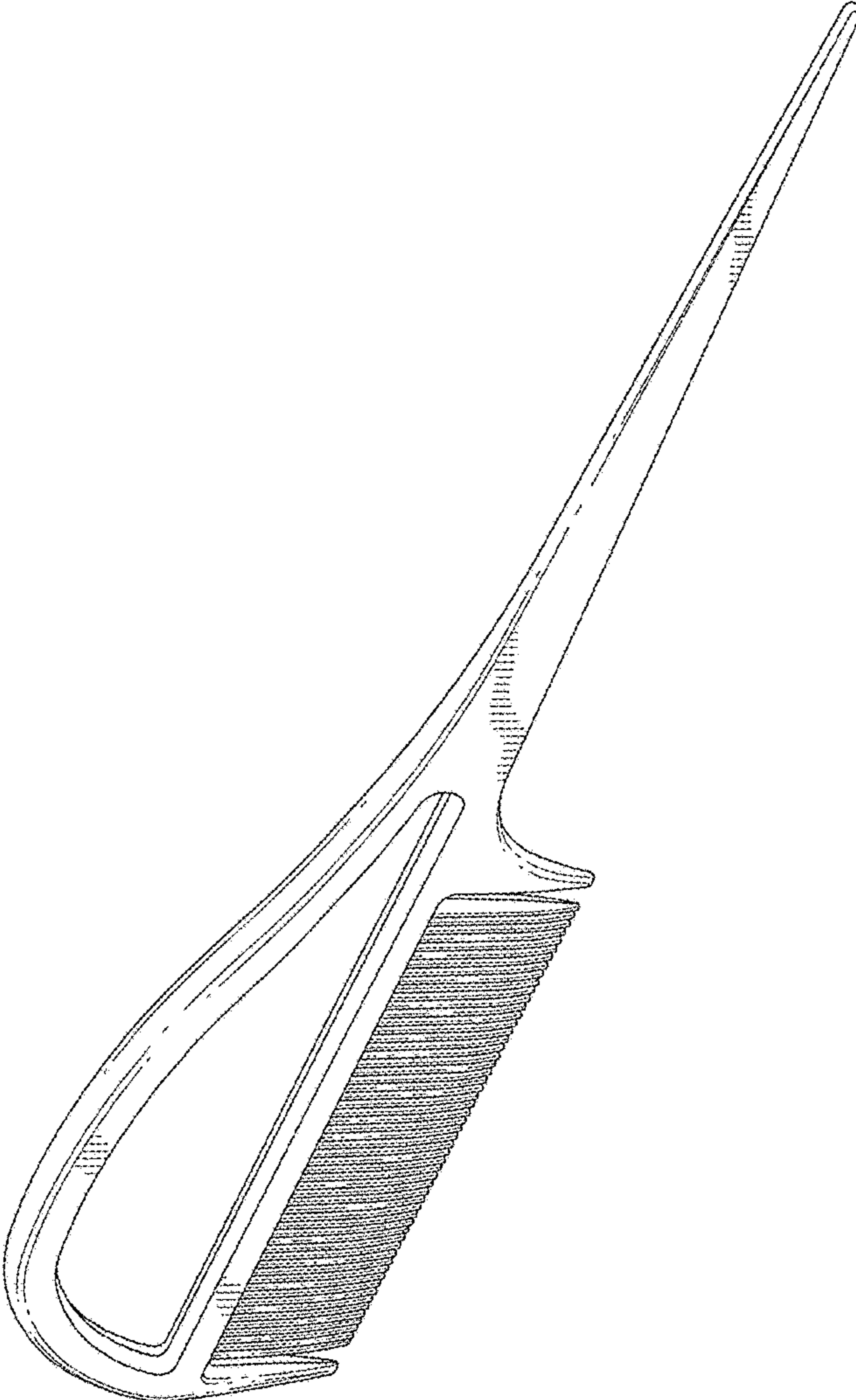

FIG. 1

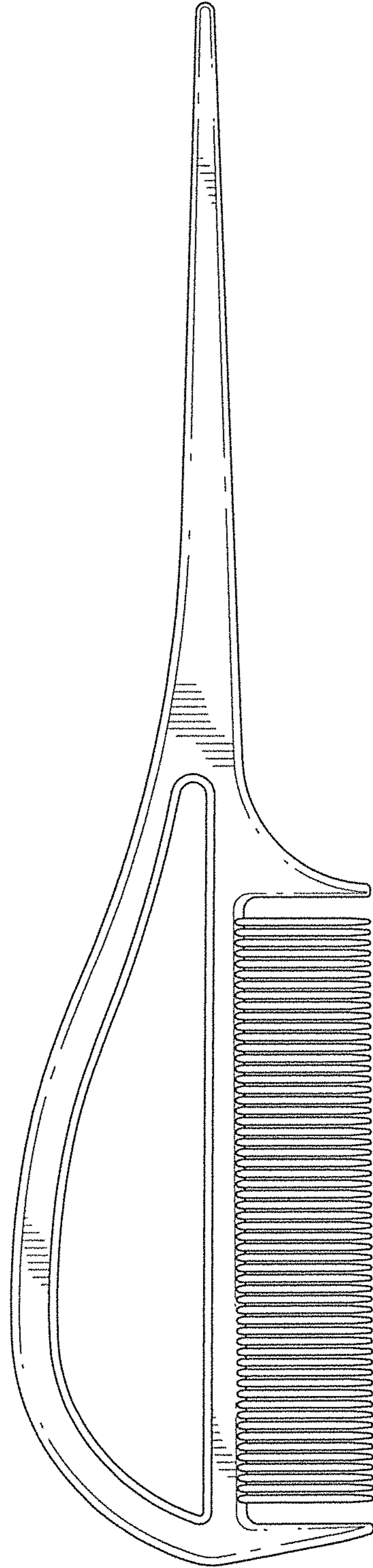

FIG. 2

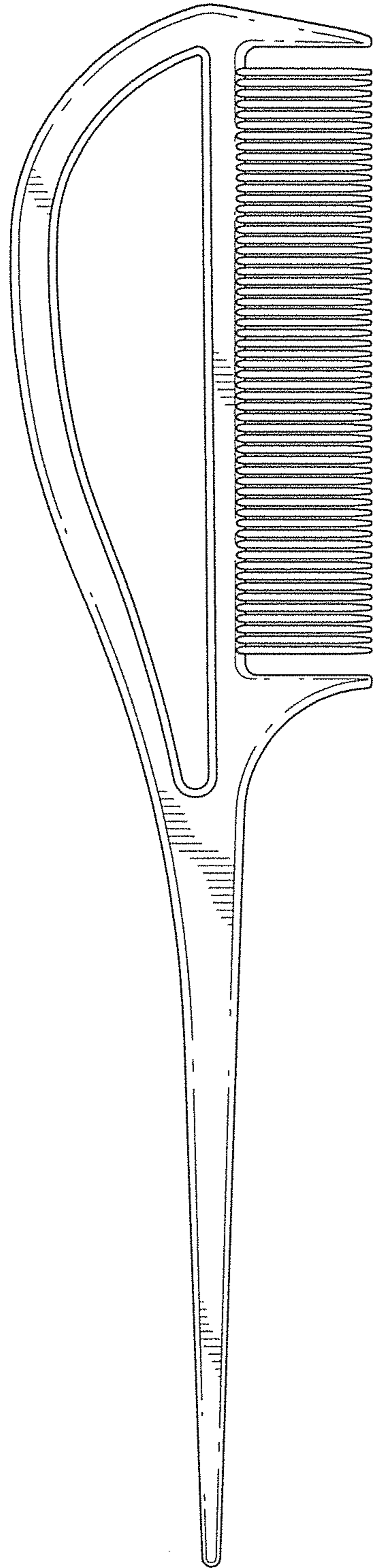

FIG. 3

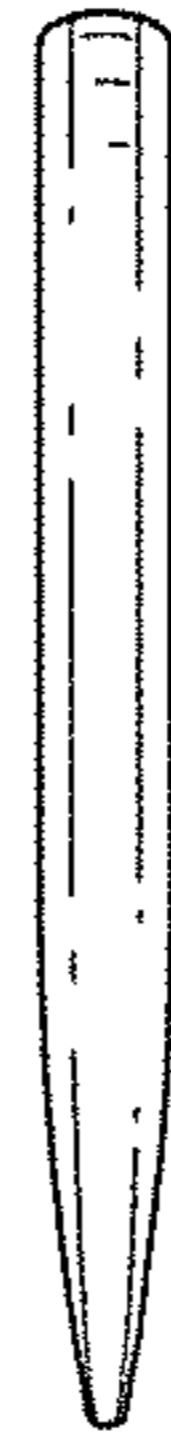

FIG. 4

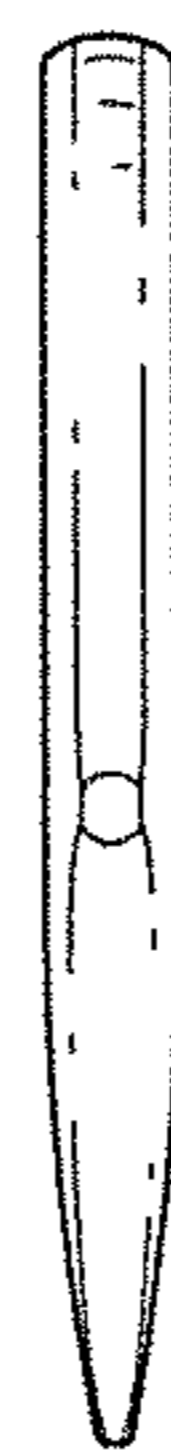

FIG. 5

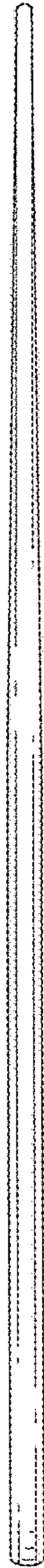

FIG. 6



FIG. 7