



US00D793570S

(12) **United States Design Patent** (10) **Patent No.:** **US D793,570 S**  
**Sherman** (45) **Date of Patent:** **\*\* Aug. 1, 2017**

(54) **HEATED GARMENT**  
(71) Applicant: **David E. Sherman**, Gardena, CA (US)  
(72) Inventor: **David E. Sherman**, Gardena, CA (US)  
(\*\*) Term: **14 Years**  
(21) Appl. No.: **29/508,472**  
(22) Filed: **Nov. 6, 2014**  
(51) **LOC (10) Cl.** ..... **24-04**  
(52) **U.S. Cl.**  
USPC ..... **D24/207**  
(58) **Field of Classification Search**  
USPC ..... D2/728, 731, 732; D24/206, 207; 2/69,  
2/70, 79, 227; 607/96, 108, 112, 114  
See application file for complete search history.

D545,028 S \* 6/2007 Myrick ..... D2/728  
D599,529 S 9/2009 Simpson  
D602,677 S \* 10/2009 Cowan ..... D2/731  
D608,981 S \* 2/2010 Cowan ..... D2/731  
D621,130 S 8/2010 Brown et al.  
D693,541 S \* 11/2013 Vanneste ..... D2/728  
D748,372 S \* 2/2016 Mazzarolo ..... D2/732  
2006/0156449 A1 7/2006 Shows

\* cited by examiner

*Primary Examiner* — Ian Simmons  
*Assistant Examiner* — Samantha Q Lawrence

(57) **CLAIM**

The ornamental design for a heated garment, as shown and described.

**DESCRIPTION**

FIG. 1 is a front view of a heated garment showing my new design;  
FIG. 2 is a rear view of the heated garment;  
FIG. 3 is a right side view of the heated garment;  
FIG. 4 is a left side view of the heated garment;  
FIG. 5 is a top view of the heated garment;  
FIG. 6 is a bottom view of the heated garment;  
FIG. 7 is a cross-sectional view of the heated garment taken along line 7-7 of FIG. 3; and,  
FIG. 8 is a cross-sectional view of the heated garment taken along line 8-8 of FIG. 4.  
The broken lines shown in FIGS. 1 through 8 illustrate portions of the heated garment that form no part of the claimed design.

(56) **References Cited**  
U.S. PATENT DOCUMENTS  
4,067,064 A \* 1/1978 Cerniway ..... B63C 11/04  
112/419  
5,038,779 A 8/1991 Barry et al.  
D337,419 S \* 7/1993 Oper ..... D2/732  
5,302,806 A 4/1994 Simmons et al.  
5,692,238 A 12/1997 Watson, Jr.  
5,826,273 A \* 10/1998 Eckes ..... A41D 13/0058  
2/115  
D409,819 S \* 5/1999 Gilchrist ..... D2/728  
5,976,176 A \* 11/1999 Webb, II ..... A61F 7/00  
607/104  
6,120,530 A 9/2000 Nuckols et al.  
D467,704 S \* 12/2002 Barrington ..... D2/731

**1 Claim, 6 Drawing Sheets**

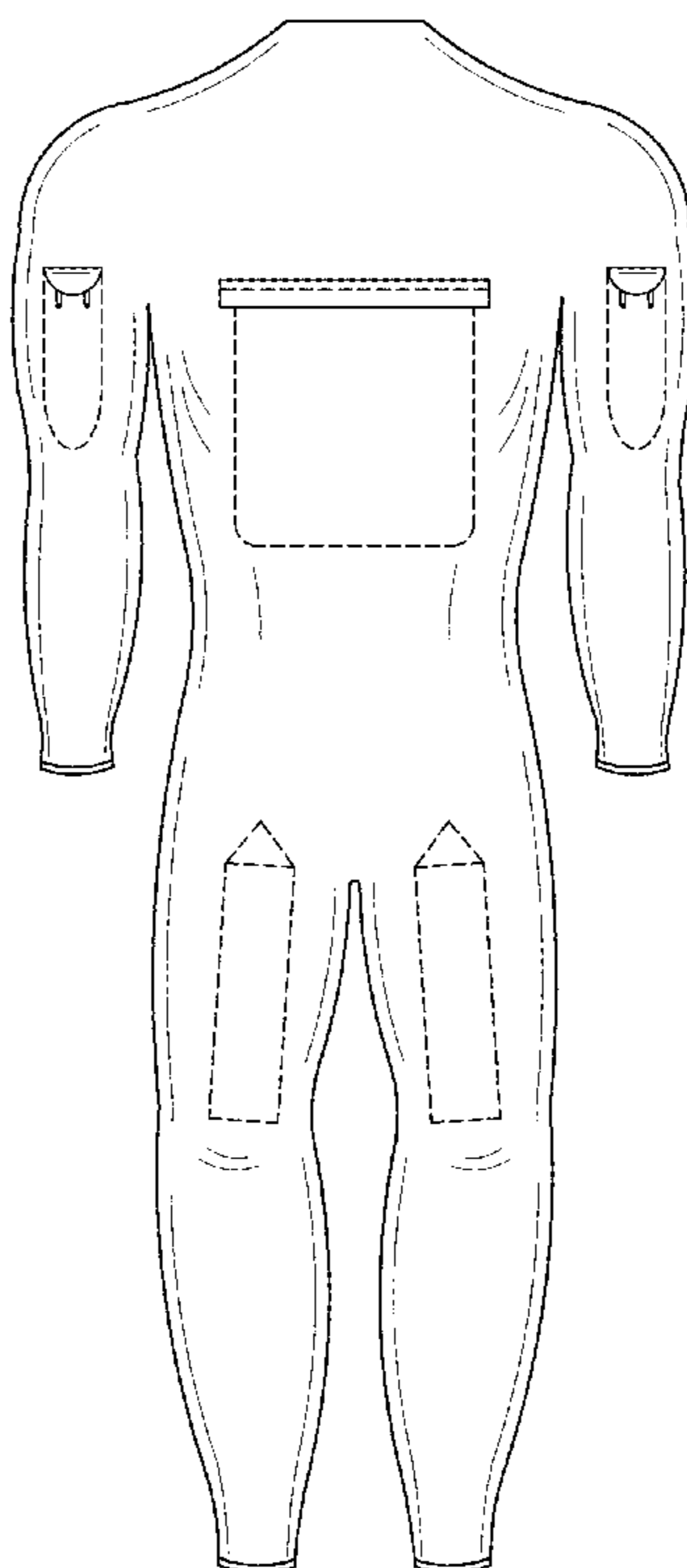

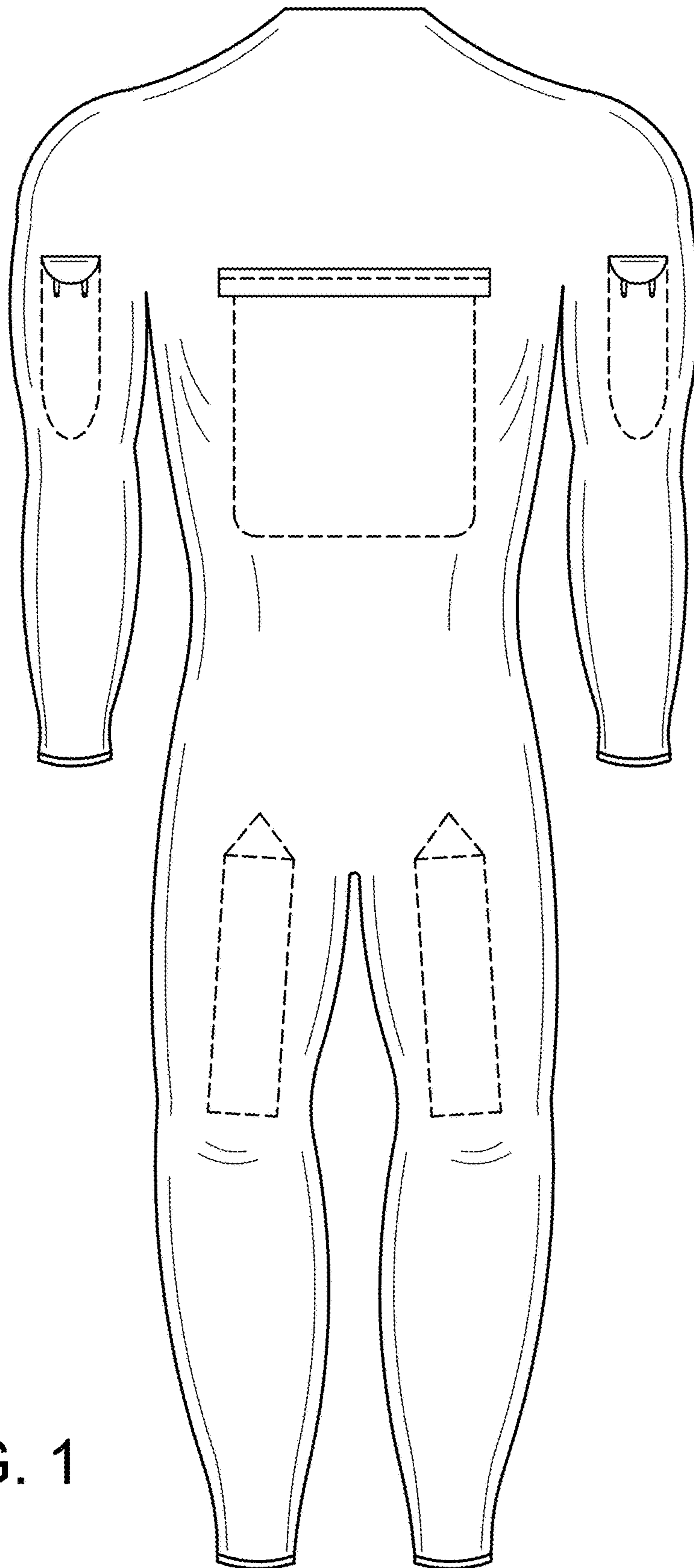

FIG. 1

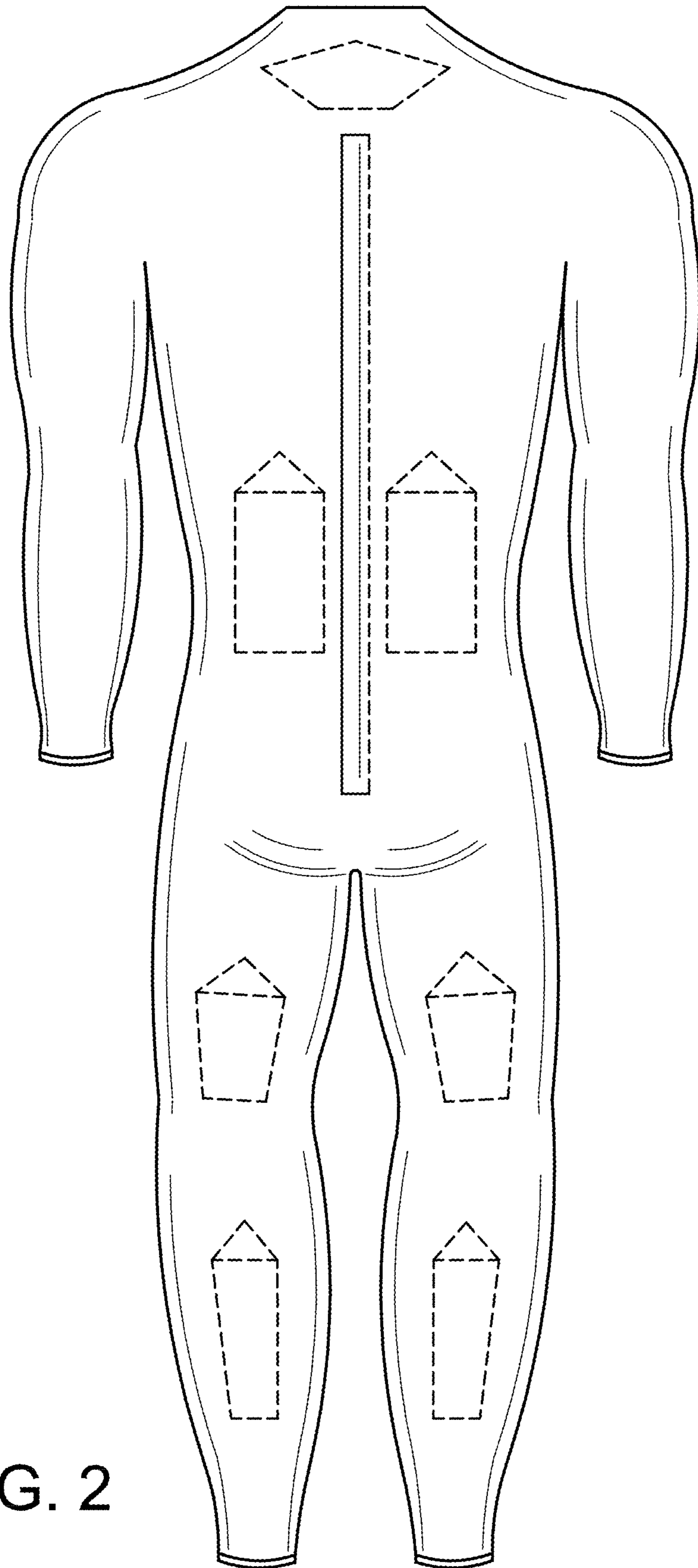

FIG. 2

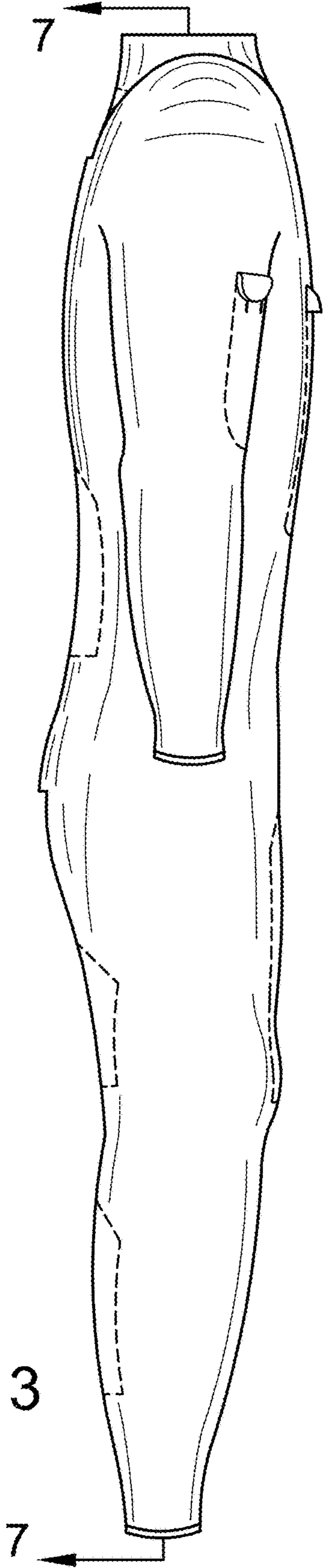

FIG. 3

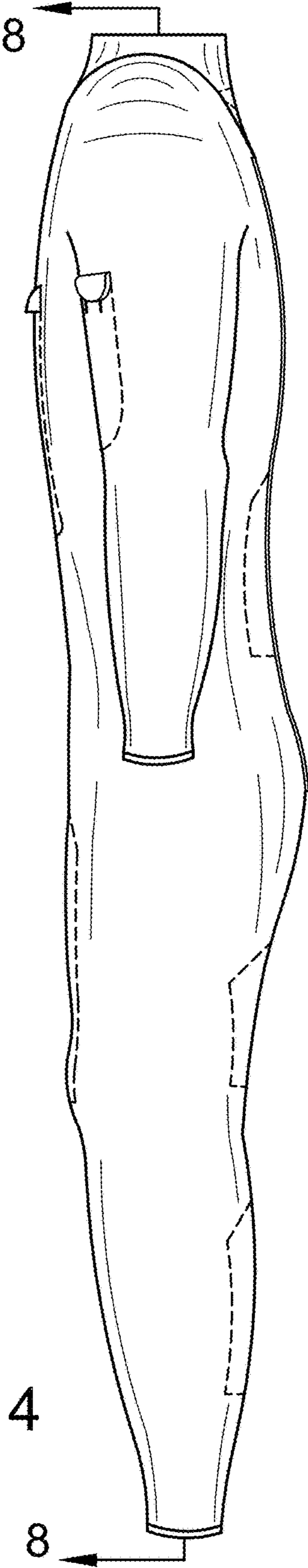

FIG. 4

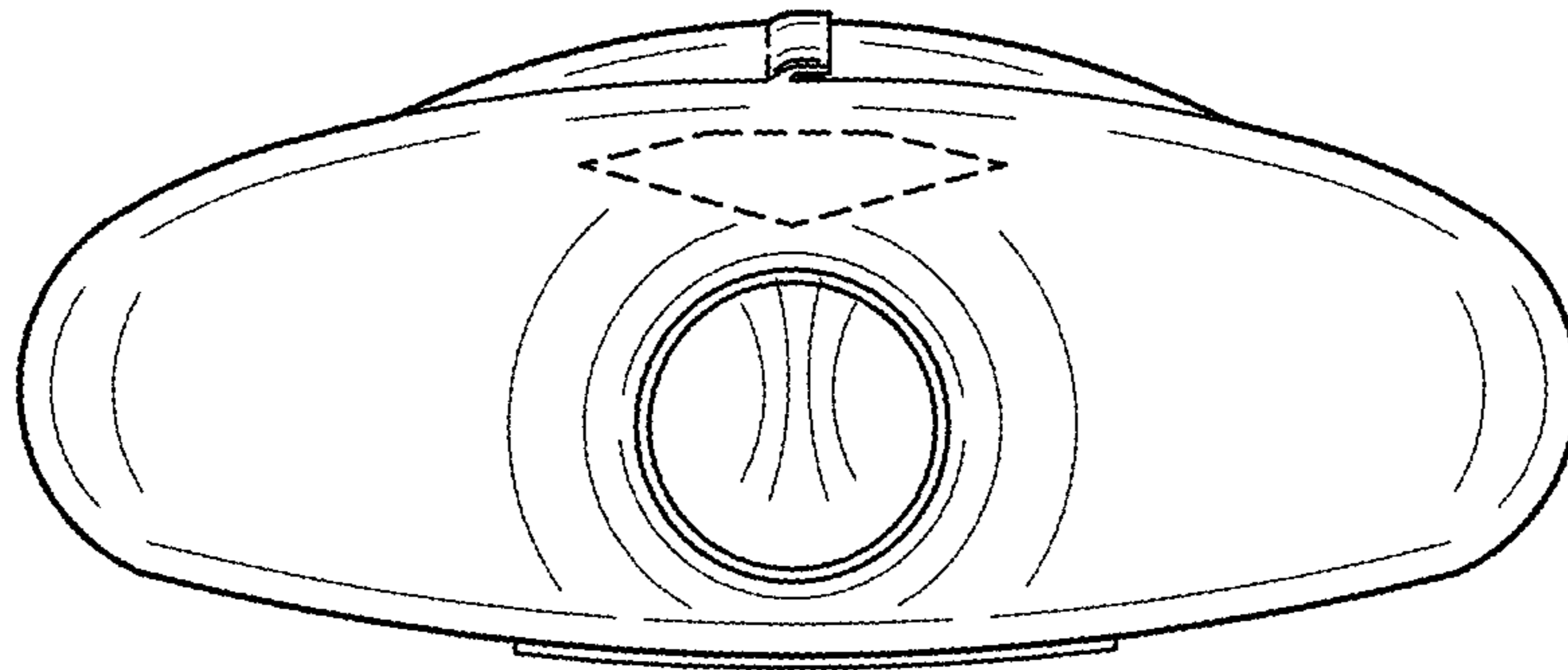

FIG. 5

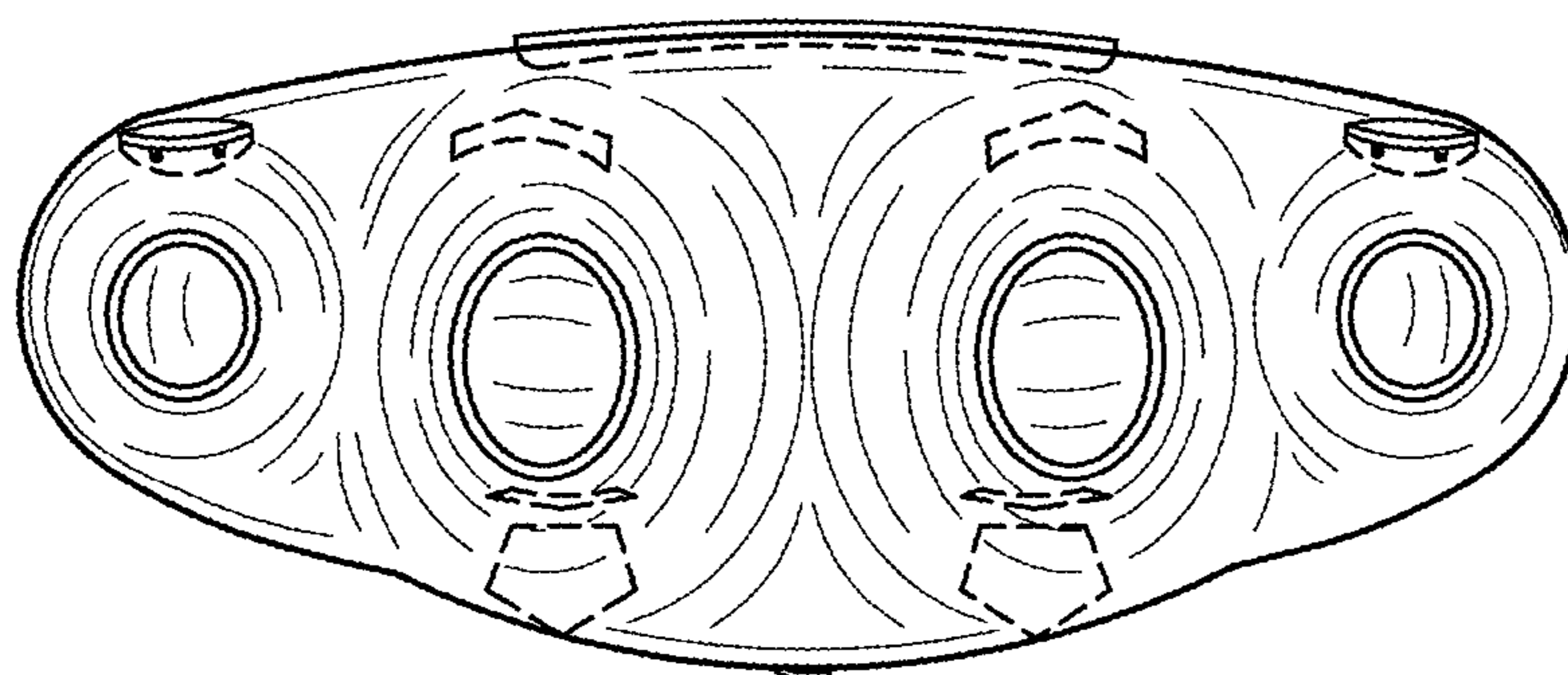

FIG. 6



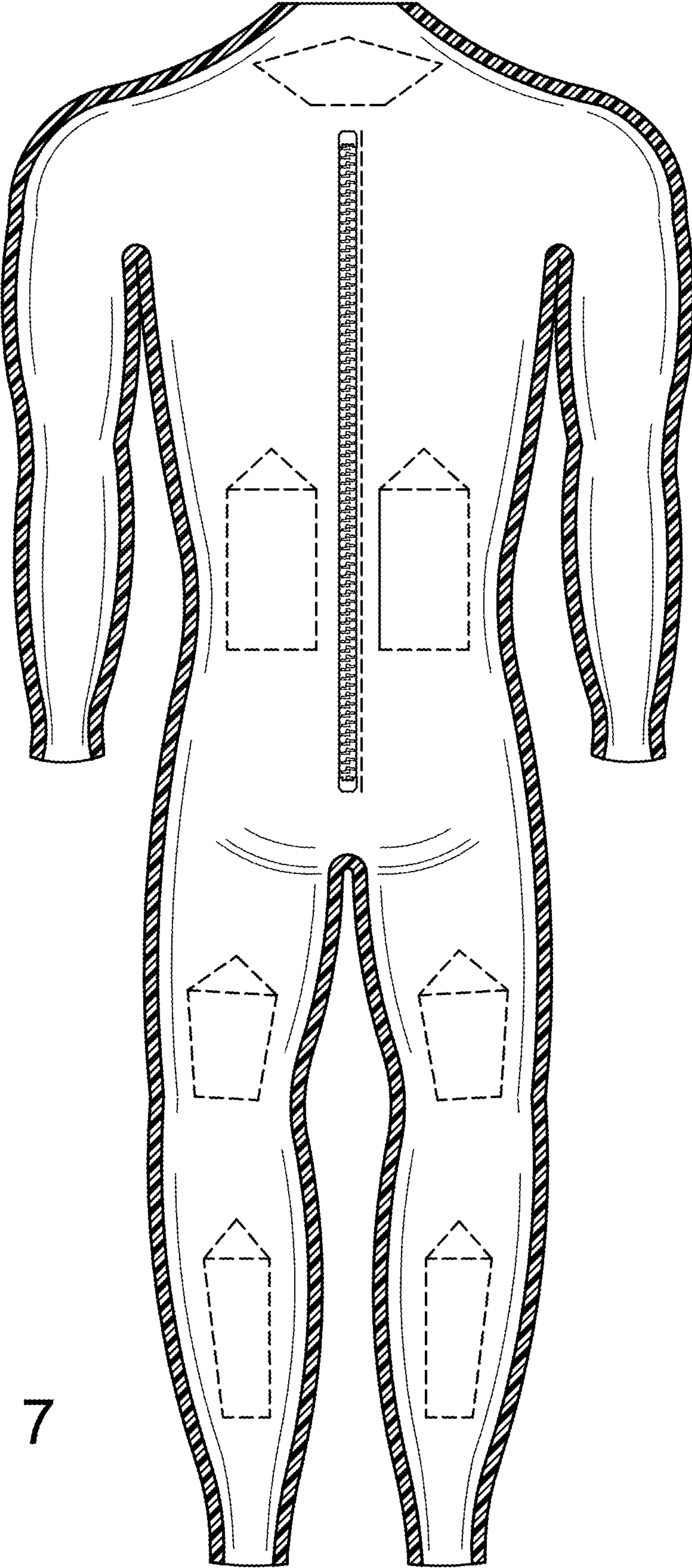

FIG. 7

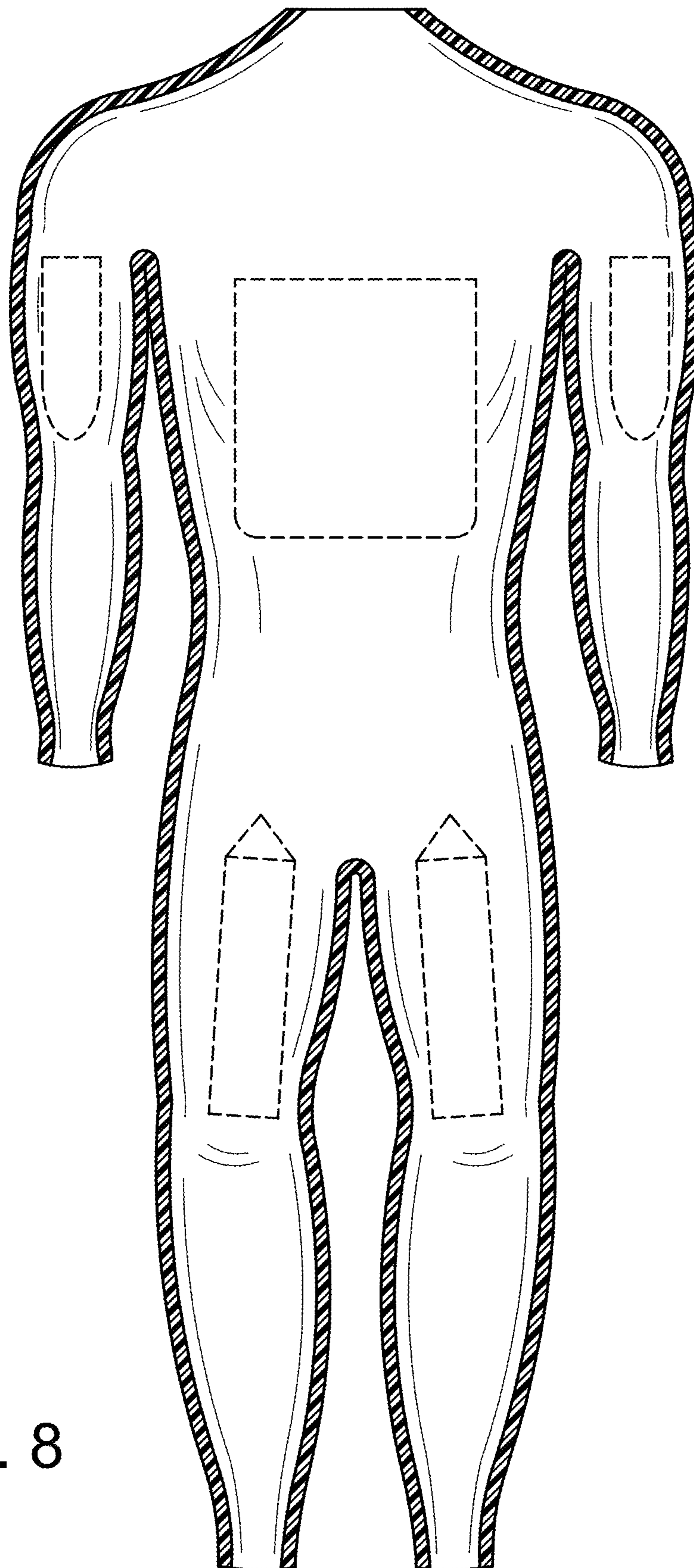

FIG. 8