



US00D793563S

(12) **United States Design Patent**
Lim

(10) **Patent No.:** **US D793,563 S**

(45) **Date of Patent:** **** Aug. 1, 2017**

(54) **SINGLE GRILLZ**

(71) Applicant: **Sungshin Metal Co., Ltd.**, Goyang,
Kyounggi-Do (KR)

(72) Inventor: **Dongyoun Lim**, Kyounggi-do (KR)

(73) Assignee: **Sungshin Metal Co., Ltd.**, Goyang,
Kyounggi-do (KR)

(**) Term: **15 Years**

(21) Appl. No.: **29/569,101**

(22) Filed: **Jun. 23, 2016**

(51) **LOC (10) Cl.** **24-99**

(52) **U.S. Cl.**
USPC **D24/181**

(58) **Field of Classification Search**
USPC D24/176-182, 152, 156; 433/206
CPC A44C 15/007; A61C 13/08; A61C 13/081;
A61C 13/082; A61C 13/0835; A61C
13/225; A61C 5/00; A61C 5/20; A61C
5/70; A61C 7/002
See application file for complete search history.

(56) **References Cited**

U.S. PATENT DOCUMENTS

5,104,320 A * 4/1992 Stoll A61C 5/00
433/206
D344,588 S * 2/1994 Park D24/180
5,810,593 A * 9/1998 White A44C 15/007
433/206

D555,793 S * 11/2007 White A61C 5/70
D24/181
D692,144 S * 10/2013 Lim D24/180
2007/0059667 A1 * 3/2007 Lim A44C 15/007
433/219
2008/0020342 A1 * 1/2008 Kim A44C 15/007
433/167
2008/0076093 A1 * 3/2008 Kim A44C 15/007
433/206
2008/0108007 A1 * 5/2008 Kong A44C 15/007
433/8

* cited by examiner

Primary Examiner — Wan Laymon

(74) *Attorney, Agent, or Firm* — Mintz Levin Cohn Ferris
Glovsky and Popeo, P.C.; Kongsik Kim

(57) **CLAIM**

The ornamental design for a single grillz, as shown and described.

DESCRIPTION

FIG. 1 is a perspective view of a single grillz according to the present invention.

FIG. 2 is a front view of the single grillz of FIG. 1.

FIG. 3 is a rear view of the single grillz of FIG. 1.

FIG. 4 is a left side view of the single grillz of FIG. 1.

FIG. 5 is a right side view of the single grillz of FIG. 1.

FIG. 6 is a top view of the single grillz of FIG. 1; and,

FIG. 7 is a bottom view of the single grillz of FIG. 1.

1 Claim, 7 Drawing Sheets

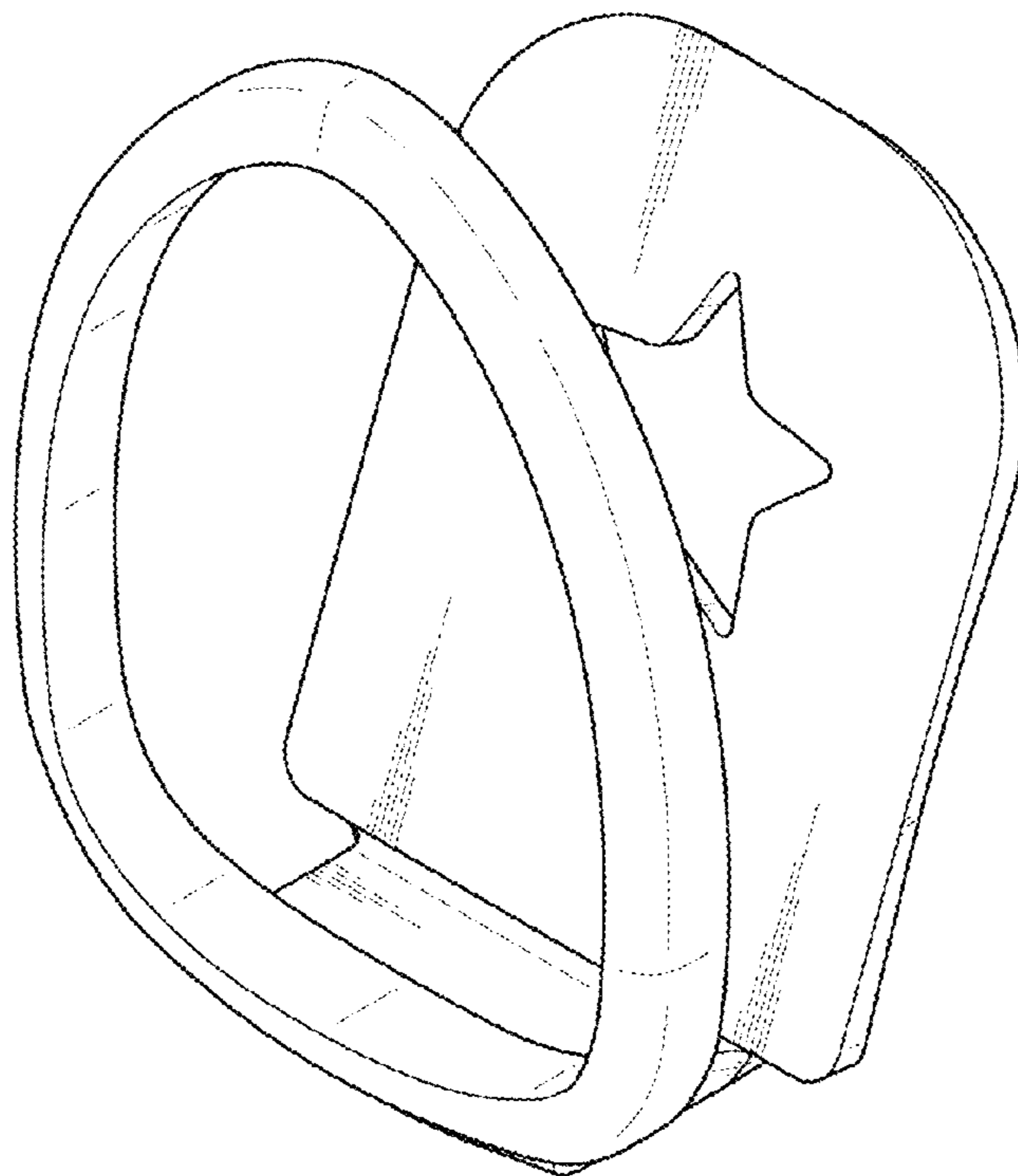

FIG. 1

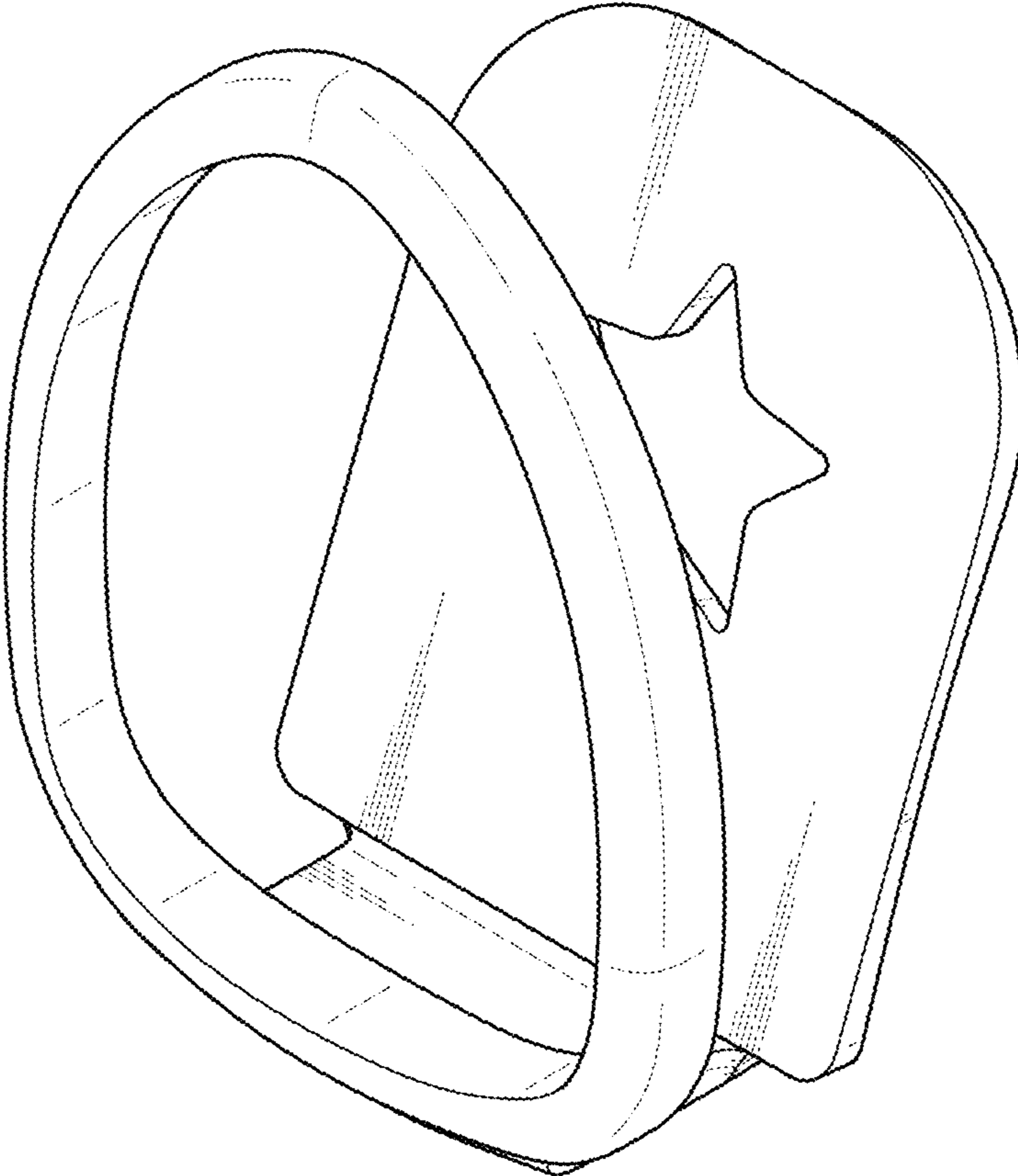

FIG. 2

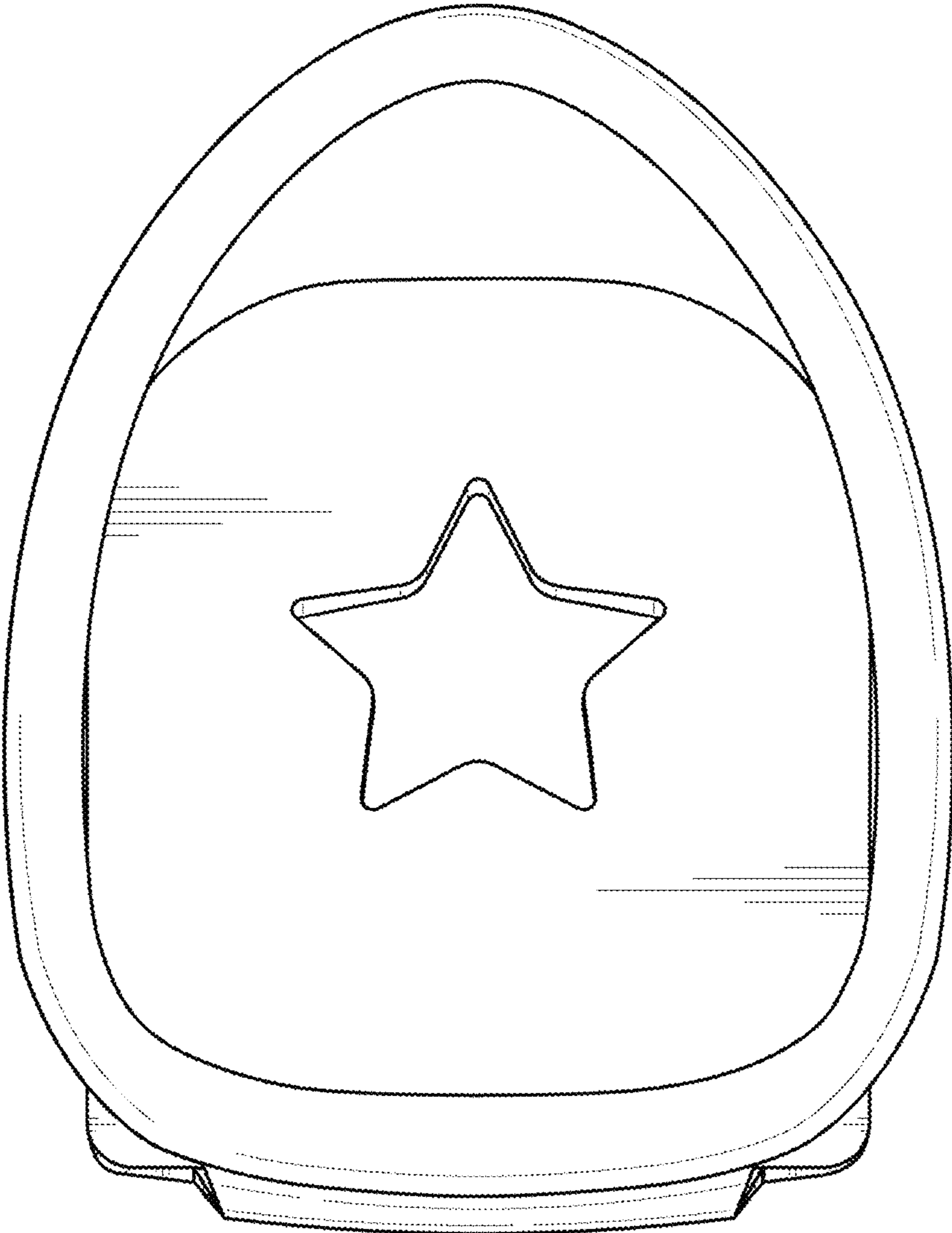

FIG. 3

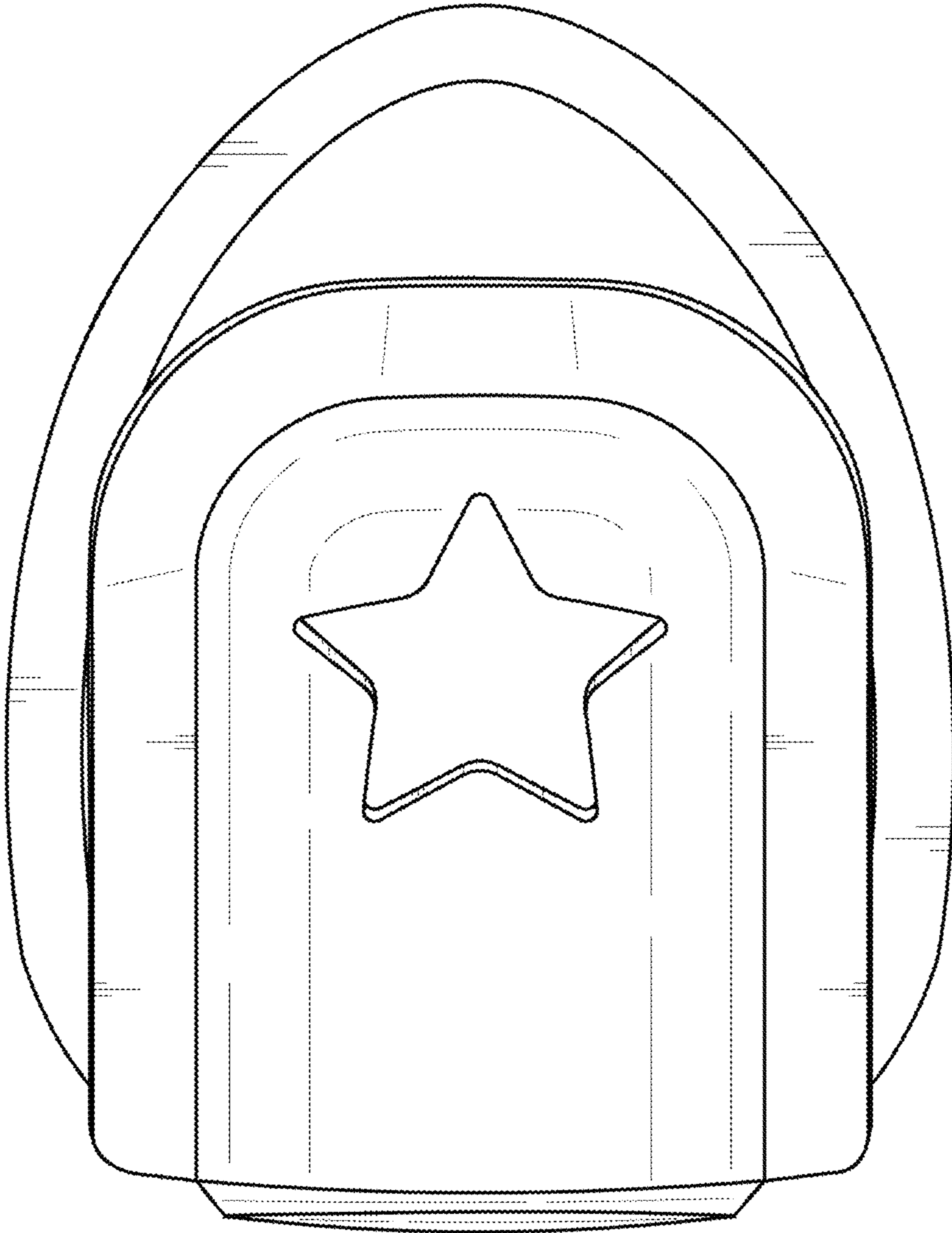

FIG. 4

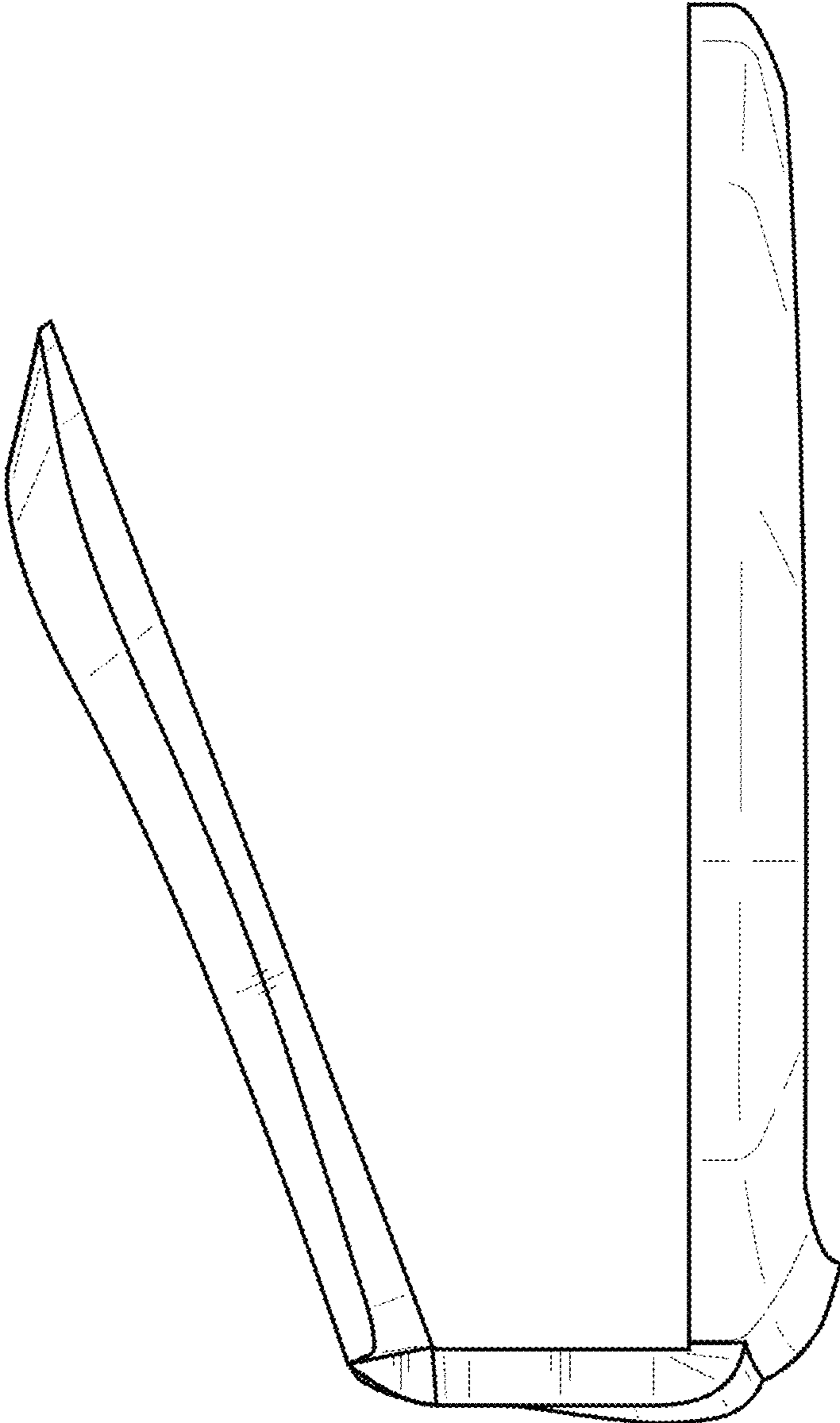

FIG. 5

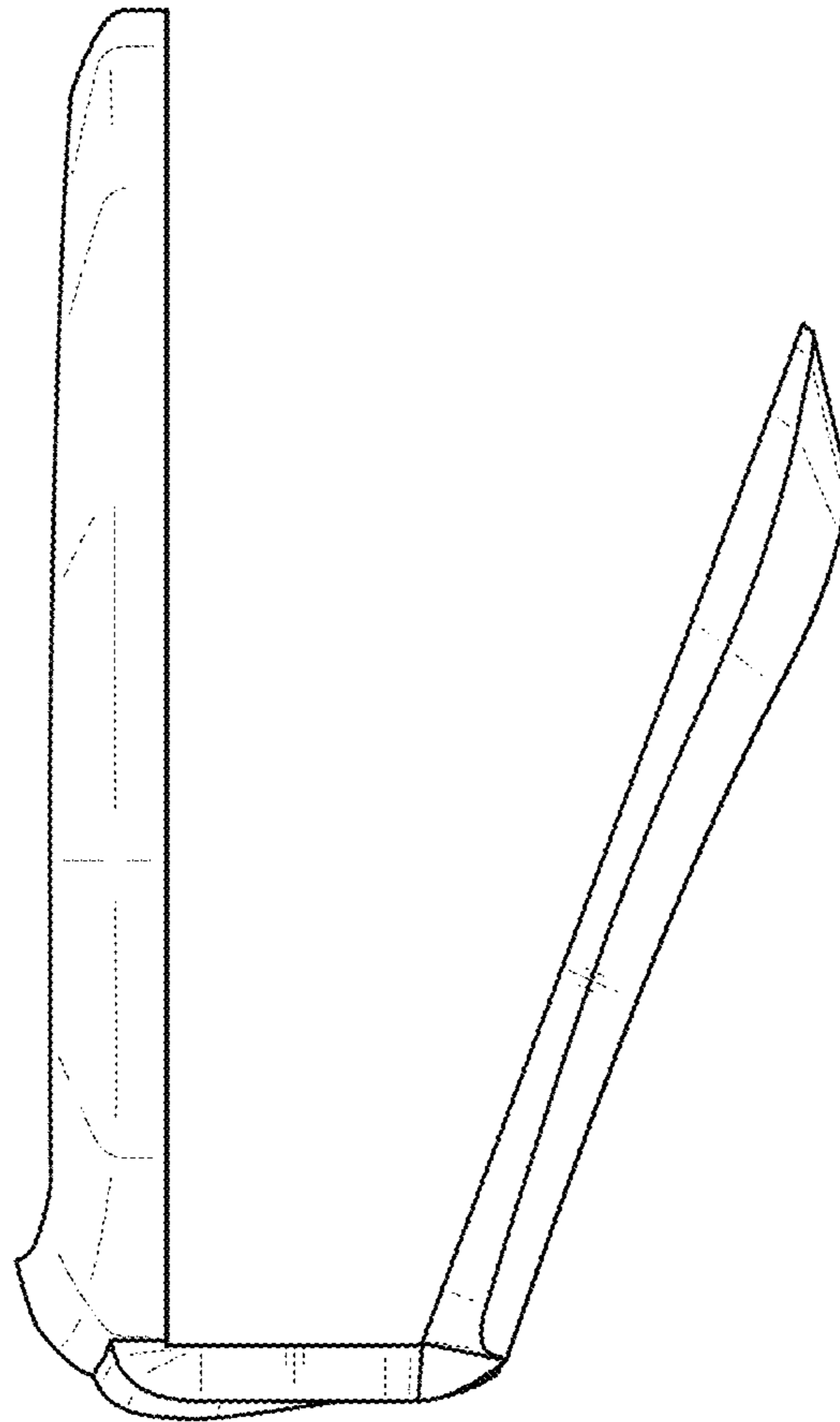

FIG. 6

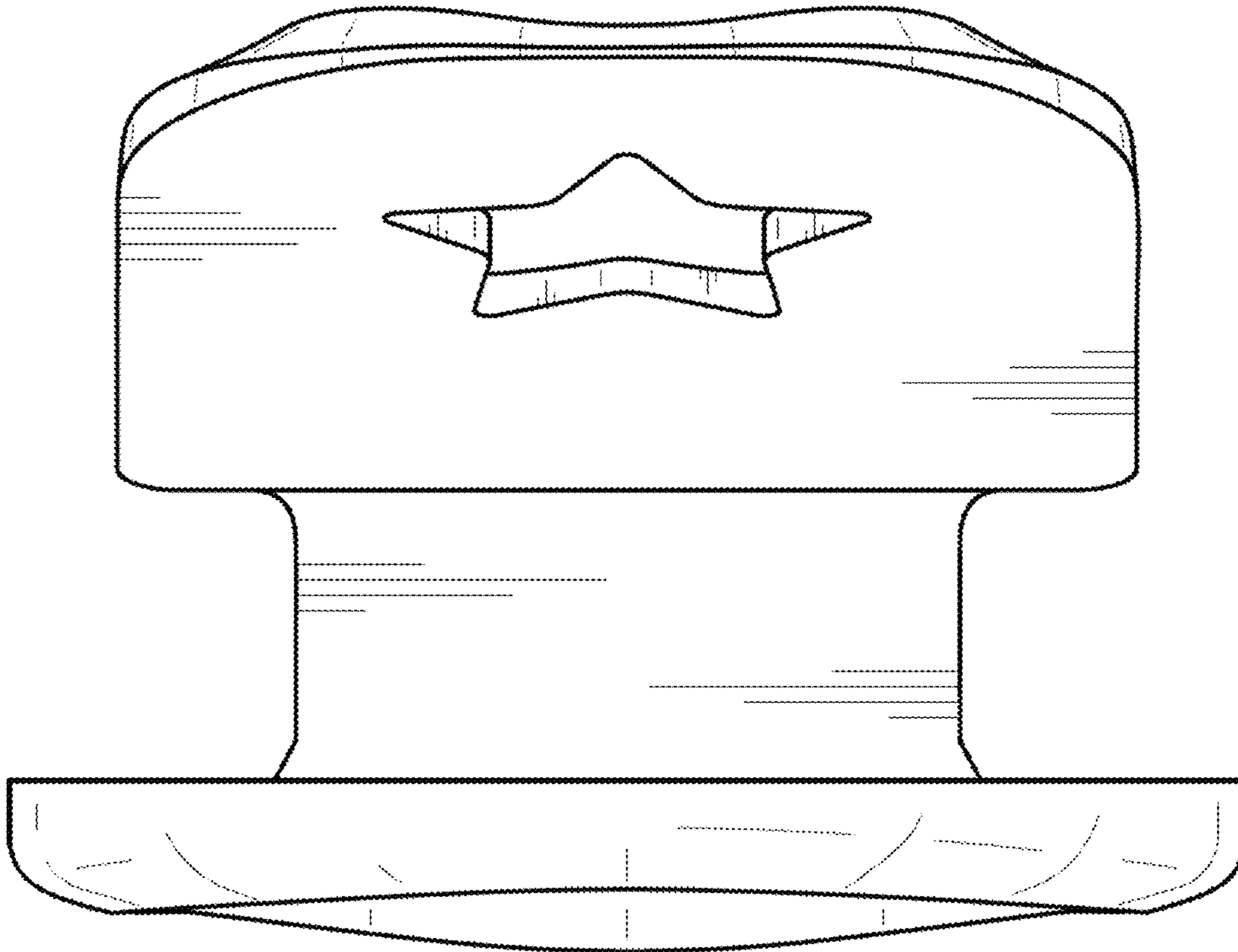

FIG. 7

