



US00D793555S

(12) **United States Design Patent**
Dupre

(10) **Patent No.:** **US D793,555 S**

(45) **Date of Patent:** **** Aug. 1, 2017**

(54) **WOUND-PACKING INSTRUMENT**

(71) Applicant: **Christopher Dupre**, Washington, LA (US)

(72) Inventor: **Christopher Dupre**, Washington, LA (US)

(**) Term: **15 Years**

(21) Appl. No.: **29/577,428**

(22) Filed: **Sep. 13, 2016**

(51) **LOC (10) Cl.** **24-02**

(52) **U.S. Cl.**
USPC **D24/141**

(58) **Field of Classification Search**
USPC D4/121, 137; D6/323; D8/307, 47, 107;
D24/133, 126, 140, 119, 146, 147, 144,
D24/137, 141; D28/7
CPC A61B 17/0057; A61B 2017/00004; A61B
2017/00637; A61B 2017/00654; A61F
13/26; A61F 13/36
See application file for complete search history.

(56) **References Cited**

U.S. PATENT DOCUMENTS

- 634,363 A 10/1899 Morrison
- 654,564 A 7/1900 Dargatz
- 682,090 A 9/1901 Lee
- 702,997 A 6/1902 Pugh
- 2,524,195 A * 10/1950 Hoover A61F 15/001
604/13
- D276,694 S * 12/1984 Benedict D8/107

- 5,007,895 A * 4/1991 Burnett A61B 17/30
604/11
- 5,350,387 A * 9/1994 Semm A61B 17/00234
604/11
- D381,426 S 7/1997 Koros
- 6,004,341 A * 12/1999 Zhu A61B 17/0057
604/161
- D541,931 S * 5/2007 Tsauro D24/119
- D545,430 S * 6/2007 Tsauro D24/119
- 7,240,390 B2 * 7/2007 Pfenniger A46B 5/0062
15/105
- 2005/0192597 A1 * 9/2005 Boebel A61B 17/0057
606/148

FOREIGN PATENT DOCUMENTS

WO 2014058992 A1 4/2014

* cited by examiner

Primary Examiner — Robert M Spear
Assistant Examiner — Eliza Bennett-Hattan

(57) **CLAIM**

I claim the ornamental design for a wound-packing instrument, as shown and described.

DESCRIPTION

FIG. 1 is a front view of the wound-packing instrument.
FIG. 2 is a back view of the claimed design.
FIG. 3 is a left side view of the claimed design.
FIG. 4 is a right side view of the claimed design.
FIG. 5 is a top view of the claimed design; and,
FIG. 6 is a bottom view of the claimed design.

1 Claim, 2 Drawing Sheets

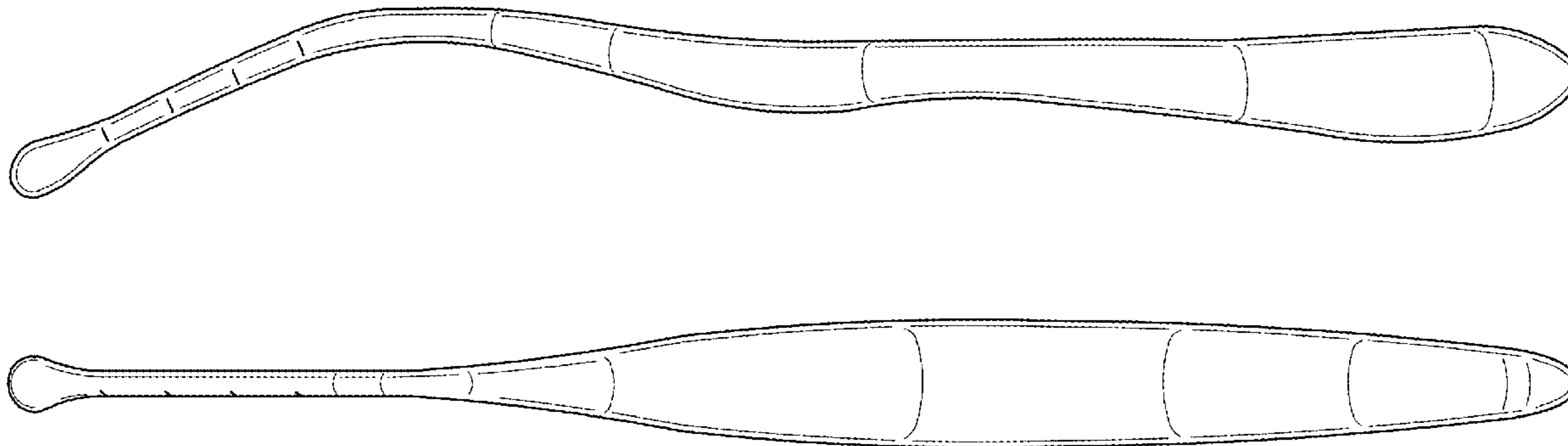

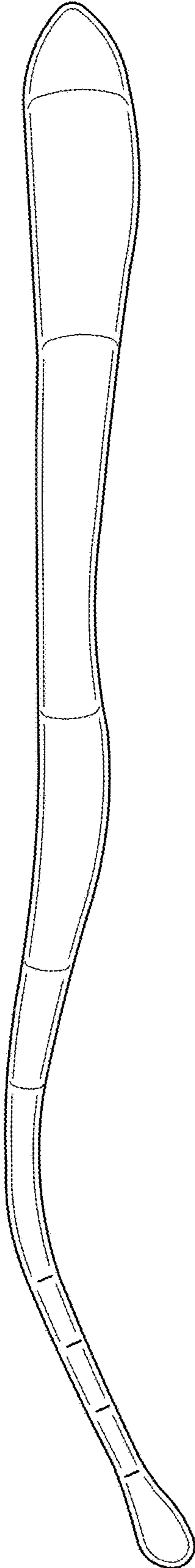

FIG. 1

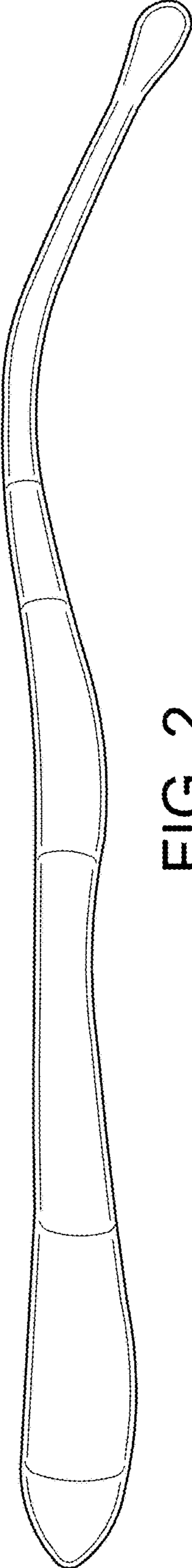

FIG. 2

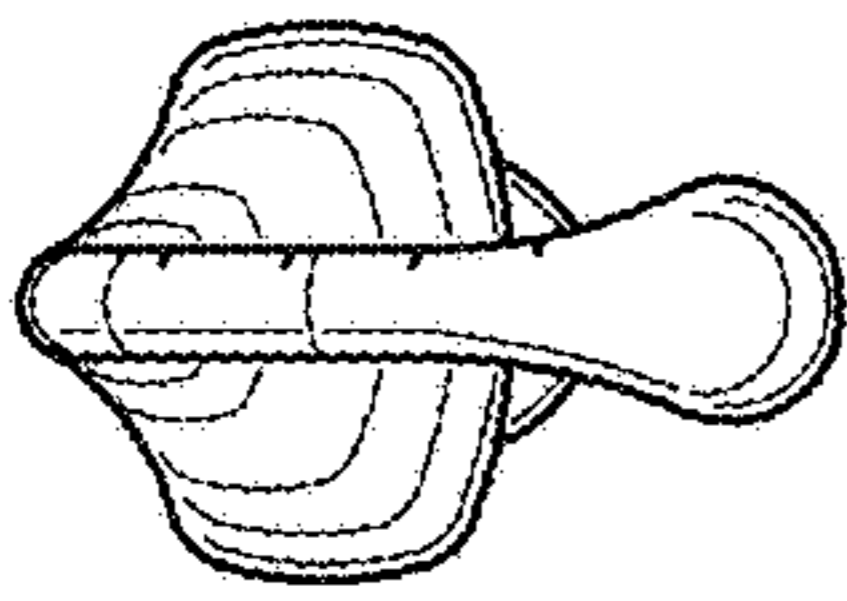

FIG. 3

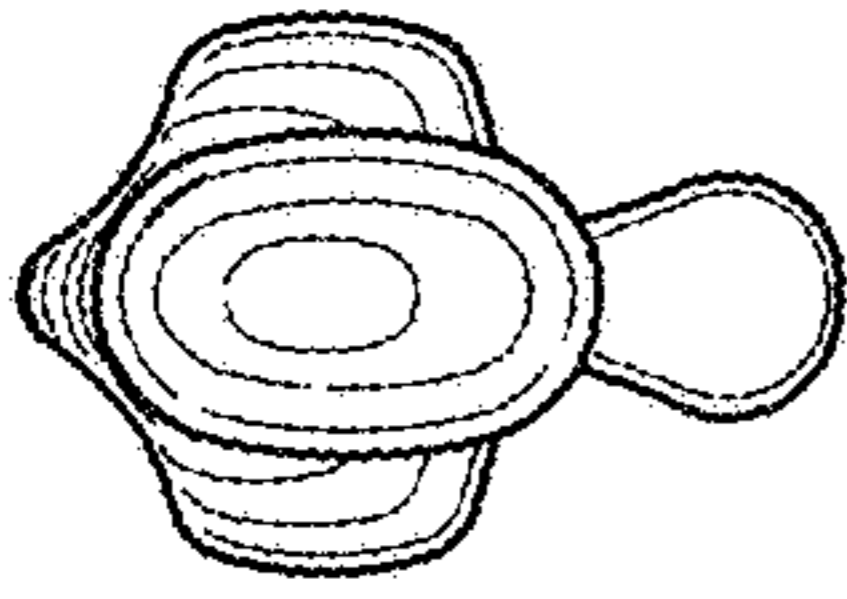

FIG. 4

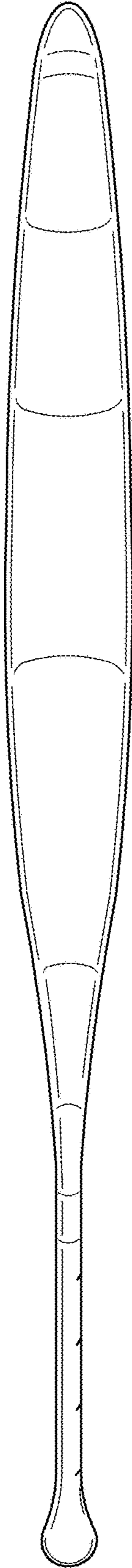

FIG. 5

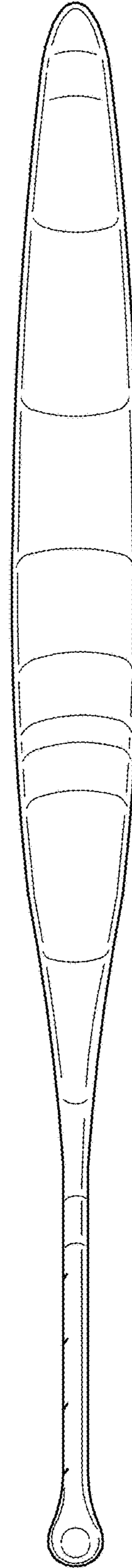

FIG. 6