



US00D793470S

(12) **United States Design Patent** (10) **Patent No.:** **US D793,470 S**
Balatti et al. (45) **Date of Patent:** **** Aug. 1, 2017**

(54) **SHOULDER REST FOR MUSICAL INSTRUMENT**

(71) Applicant: **THE KUN SHOULDER REST INC.**, Ottawa (CA)

(72) Inventors: **Aldo Balatti**, Ottawa (CA); **Marina Kun**, Ottawa (CA)

(73) Assignee: **The Kun Shoulder Rest Inc.**, Ottawa (CA)

(**) Term: **14 Years**

(21) Appl. No.: **29/519,749**

(22) Filed: **Mar. 6, 2015**

(30) **Foreign Application Priority Data**

Feb. 11, 2015 (CA) 160885

(51) **LOC (10) Cl.** **17-03**

(52) **U.S. Cl.**
USPC **D17/20**

(58) **Field of Classification Search**
USPC D26/2, 28, 60, 72, 89, 104, 113, 118,
D26/119, 120, 122, 124, 128, 138, 142,
(Continued)

(56) **References Cited**

U.S. PATENT DOCUMENTS

904,258 A * 11/1908 Henrickson et al. G10D 3/18
84/278

D46,490 S * 10/1914 Beoker 84/271
(Continued)

OTHER PUBLICATIONS

Violin shoulder rest, image post date Oct. 17, 2013, site visited Feb. 6, 2016, (online), <<http://web.archive.org/web/20131017151730/http://menzel-music.com/?p=48>>.*

(Continued)

Primary Examiner — Kevin Rudzinski
Assistant Examiner — Sean D Lough
(74) *Attorney, Agent, or Firm* — Neal, Gerber & Eisenberg LLP

(57) **CLAIM**

The ornamental design for the shoulder rest for musical instrument, as shown and described.

DESCRIPTION

FIG. 1 is a bottom perspective view of a shoulder rest for musical instrument with the forks positioned in a retracted and open posture;

FIG. 2 is a bottom perspective view of the shoulder rest for musical instrument with the forks positioned in an extended and open posture;

FIG. 3 is a bottom view of the shoulder rest of FIG. 1;

FIG. 4 is a bottom view of the shoulder rest of FIG. 2;

FIG. 5 is a side view of the shoulder rest of FIG. 1;

FIG. 6 is a side view of the shoulder rest of FIG. 2;

FIG. 7 is an end view of the shoulder rest of FIG. 1;

FIG. 8 is an end view of the shoulder rest of FIG. 2;

FIG. 9 is a top view of the shoulder rest of FIG. 1;

FIG. 10 is a top view of the shoulder rest of FIG. 2;

FIG. 11 is a top perspective view of the shoulder rest of FIG. 1;

FIG. 12 is a top perspective view of the shoulder rest of FIG. 2;

FIG. 13 is a top perspective view of the shoulder rest with the forks in a folded posture;

FIG. 14 is a bottom perspective view of the shoulder rest with the forks in the folded posture; and,

FIG. 15 is another bottom perspective view of the shoulder rest with the forks in the folded posture.

The broken lines present in the FIGURES illustrate portions of the shoulder rest for musical instrument that form no part of the claimed design.

1 Claim, 11 Drawing Sheets

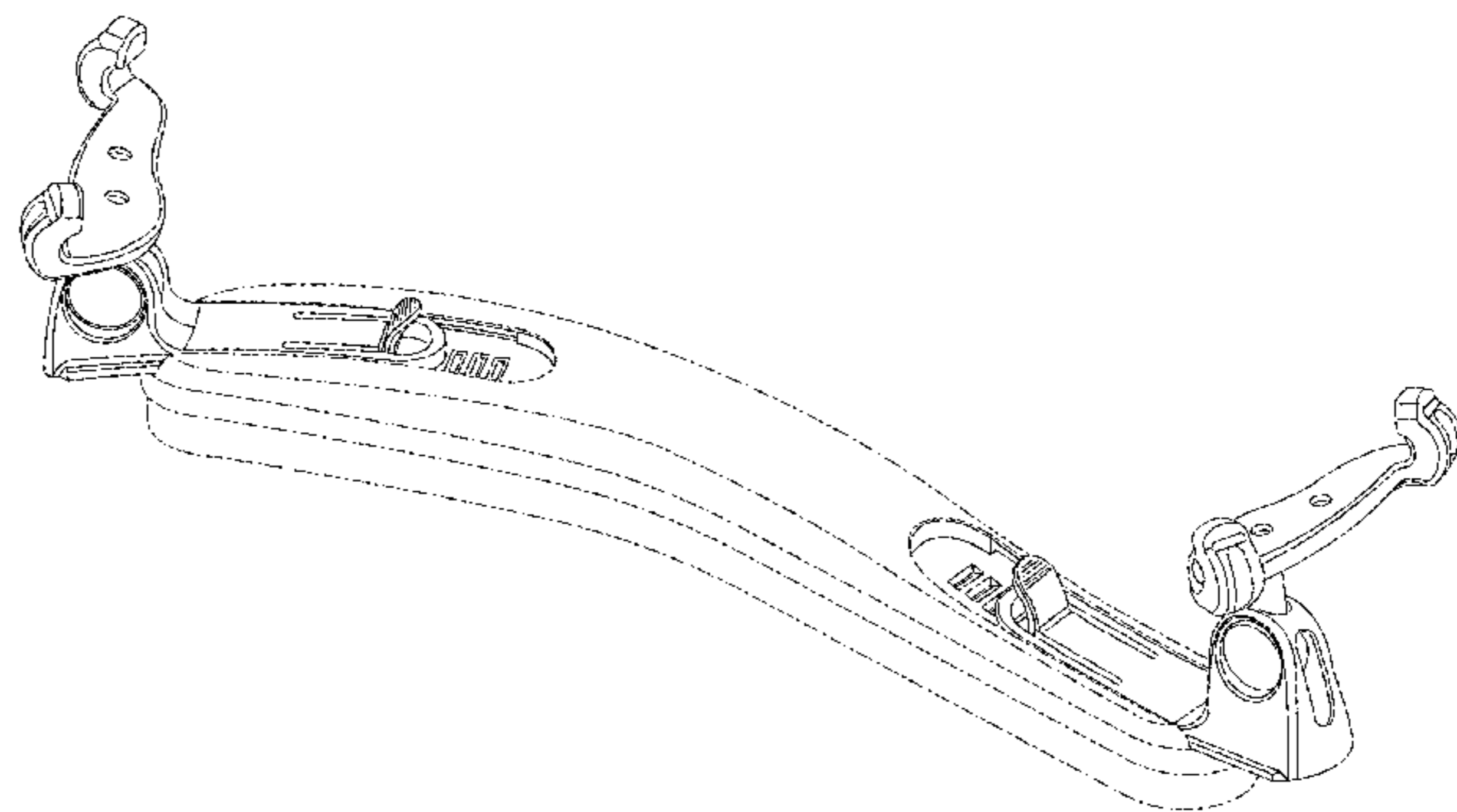
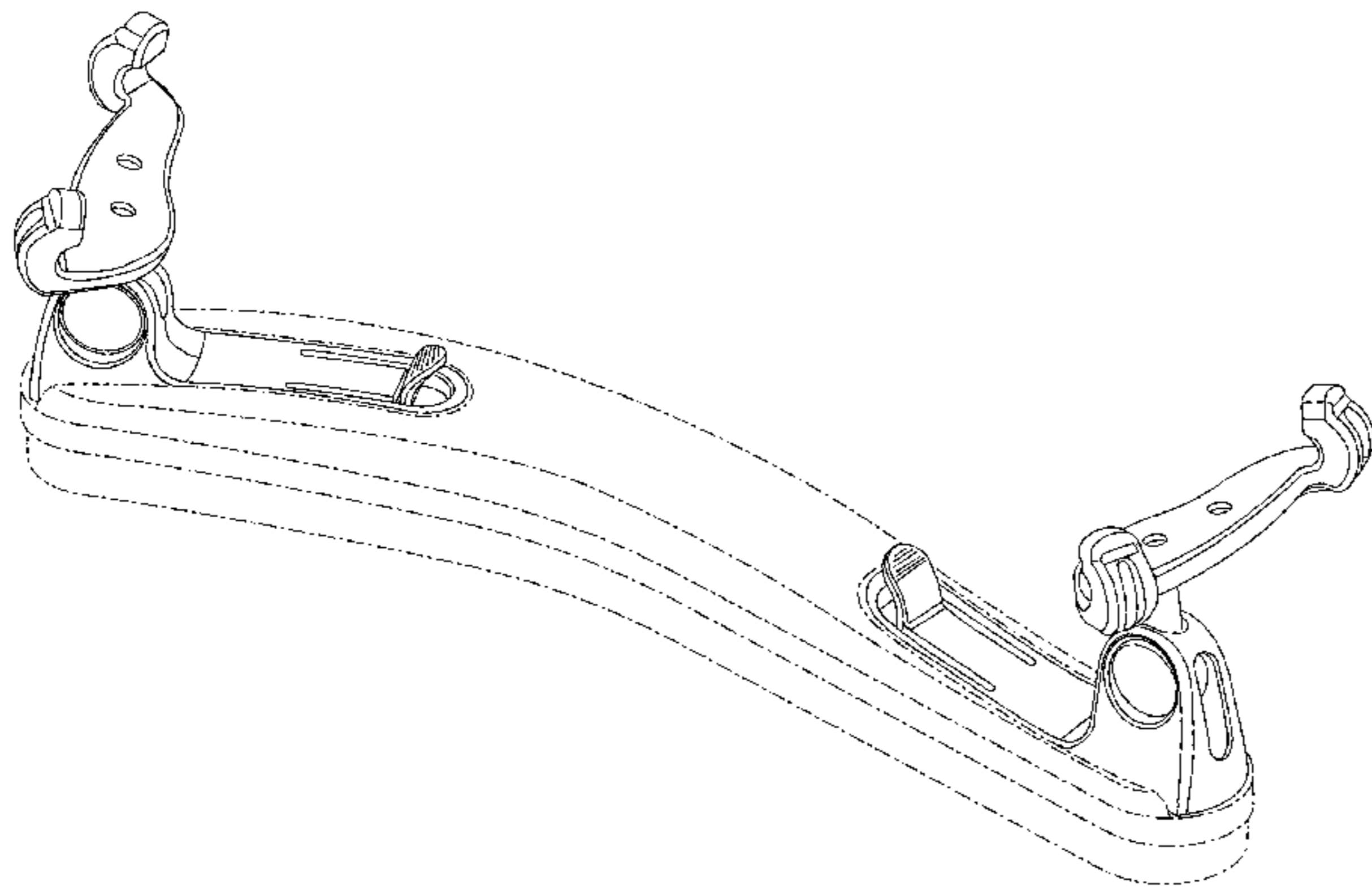

US D793,470 S

(58) Field of Classification Search

USPC D26/143, 145; D13/179, 180, 102, 103, D13/107, 108; D10/18, 21, 24, 25, 27, D10/28, 46, 93, 104.1, 106, 113, 114, D10/116.1; D17/9, 13, 20, 22, 23, 24, D17/99; D21/586; D28/7; D6/582, 583, D6/585, 592, 595, 596, 597, 601, 602, D6/603, 606, 608, 610, 617
 CPC H01L 2224/48137; F21V 29/006; F21Y 2101/02; F21K 9/00; H05K 7/20727; H05K 7/20581; F04D 25/166; F04D 15/00; F04D 29/664; F24F 3/044; F24F 7/06; F24F 7/065; F24F 13/24; G10D 13/00; G10D 3/00; G10D 3/18; G10G 5/00; A63H 5/00; A47G 9/00; B60N 2/00
 See application file for complete search history.

5,419,226 A 5/1995 Kun
 5,567,893 A 10/1996 Kun
 D385,292 S 10/1997 Kun
 D390,252 S * 2/1998 Burward-Hoy 84/278
 5,731,531 A 3/1998 Kun
 D394,481 S * 5/1998 DeLisse D21/694
 D406,269 S * 3/1999 Mach D17/20
 6,031,163 A 2/2000 Cullum et al.
 6,061,857 A * 5/2000 Deneau A47C 27/144
 5/495
 D431,832 S * 10/2000 Stuart D17/20
 6,291,750 B1 9/2001 Farha
 6,369,303 B1 * 4/2002 Hvezda G10D 3/18
 84/278
 6,670,533 B1 * 12/2003 Yeh G10D 3/18
 84/278
 6,680,431 B2 * 1/2004 Vanden G10D 3/18
 84/278
 D512,892 S * 12/2005 Gibbons D8/70
 7,265,284 B2 9/2007 Muir et al.
 D561,236 S 2/2008 Muir et al.
 D564,604 S * 3/2008 Mikail D21/688
 7,368,645 B2 * 5/2008 Armstrong G10D 3/18
 84/278
 7,385,124 B2 * 6/2008 Clemente G10D 3/18
 84/278
 7,531,727 B2 * 5/2009 Buttemer G10D 3/18
 84/278
 7,844,069 B2 * 11/2010 Banks H04R 1/08
 381/361
 D631,276 S * 1/2011 White D6/582
 D635,615 S * 4/2011 Foster D21/324
 D636,014 S * 4/2011 Cheng D17/20
 8,119,894 B2 * 2/2012 Cheng G10D 3/18
 84/327
 8,492,628 B2 * 7/2013 Ruan G10D 3/18
 84/279
 8,492,629 B2 * 7/2013 Johnson G10D 3/18
 84/280
 D688,732 S * 8/2013 Johnson D17/20
 8,550,843 B2 * 10/2013 Van Swearingen H01R 9/05
 439/317
 D717,366 S * 11/2014 Korfker D17/20
 8,957,290 B2 * 2/2015 Vochezer 84/280
 D724,163 S * 3/2015 Kelley D21/694
 D730,574 S * 5/2015 Long D28/7
 D741,963 S * 10/2015 Baumann D21/688
 D748,321 S * 1/2016 Grimm D26/128
 D753,253 S * 4/2016 Chiu D21/688
 9,311,903 B1 * 4/2016 Balatti G10D 3/18
 2005/0016355 A1 * 1/2005 Huang G10D 3/18
 84/328
 2005/0120860 A1 * 6/2005 Chen G10D 3/18
 84/328
 2005/0282691 A1 * 12/2005 Hakooz A63B 22/0056
 482/148
 2006/0174743 A1 * 8/2006 Clemente G10D 3/18
 84/279
 2008/0196570 A1 * 8/2008 Cheng G10D 3/18
 84/280
 2009/0211426 A1 * 8/2009 Penic G10D 3/18
 84/280
 2010/0242703 A1 * 9/2010 Ruan G10D 3/18
 84/280
 2013/0125728 A1 * 5/2013 Korfker G10D 3/18
 84/280
 2013/0276611 A1 * 10/2013 Vochezer G10G 5/005
 84/280
 2014/0090539 A1 * 4/2014 Korfker G10D 3/18
 84/280
 2014/0290460 A1 * 10/2014 Vochezer G10D 3/18
 84/280
 2015/0187342 A1 * 7/2015 Stern G10D 3/18
 84/280

(56) References Cited

U.S. PATENT DOCUMENTS

1,361,049 A * 12/1920 Hafelfinger G10D 3/14
 290/7
 1,756,676 A * 4/1930 Colbentson G10D 3/18
 84/280
 1,792,608 A * 2/1931 Schulenberg G10D 3/14
 84/302
 1,879,386 A * 9/1932 Medakovic G10D 3/18
 84/280
 2,216,052 A * 9/1940 Spetseris G10D 3/18
 84/280
 2,248,854 A * 7/1941 Coffeen G10D 3/18
 84/280
 2,489,101 A * 11/1949 Mills G10D 3/18
 84/280
 2,522,944 A * 9/1950 Goldberger G10D 3/18
 84/280
 2,697,374 A * 12/1954 Ungh G10D 3/18
 84/280
 2,746,336 A * 5/1956 Bisharat G10D 3/18
 84/280
 2,747,452 A * 5/1956 Goldberger G10D 3/18
 84/280
 3,298,269 A * 1/1967 White G10D 3/18
 84/278
 3,372,614 A * 3/1968 Galster G10D 3/18
 84/280
 3,631,754 A * 1/1972 Kun G10D 3/18
 84/280
 3,683,098 A * 8/1972 Chavez, Jr. G10D 3/18
 84/278
 3,690,211 A * 9/1972 Long G10D 3/18
 84/280
 3,896,694 A * 7/1975 Goldner G10D 3/18
 248/230.8
 D254,012 S * 1/1980 Lenski D17/20
 4,333,378 A * 6/1982 Hrdlicka G10D 3/18
 84/280
 4,386,548 A * 6/1983 Wolf G10D 3/18
 84/280
 4,506,582 A * 3/1985 Goldner G10D 3/18
 84/280
 4,534,259 A * 8/1985 Wolf G10D 3/18
 84/279
 D334,019 S * 3/1993 Kun 84/280
 5,208,409 A * 5/1993 Roulet G10D 3/18
 84/278
 5,270,474 A 12/1993 Kun
 5,275,078 A * 1/1994 Wolf G10D 3/18
 84/280
 D352,053 S * 11/1994 Murray 84/280
 5,408,912 A * 4/1995 Baity G10D 3/04
 84/307

7,385,124 B2 * 6/2008 Clemente G10D 3/18
 84/278
 7,531,727 B2 * 5/2009 Buttemer G10D 3/18
 84/278
 7,844,069 B2 * 11/2010 Banks H04R 1/08
 381/361
 D631,276 S * 1/2011 White D6/582
 D635,615 S * 4/2011 Foster D21/324
 D636,014 S * 4/2011 Cheng D17/20
 8,119,894 B2 * 2/2012 Cheng G10D 3/18
 84/327
 8,492,628 B2 * 7/2013 Ruan G10D 3/18
 84/279
 8,492,629 B2 * 7/2013 Johnson G10D 3/18
 84/280
 D688,732 S * 8/2013 Johnson D17/20
 8,550,843 B2 * 10/2013 Van Swearingen H01R 9/05
 439/317
 D717,366 S * 11/2014 Korfker D17/20
 8,957,290 B2 * 2/2015 Vochezer 84/280
 D724,163 S * 3/2015 Kelley D21/694
 D730,574 S * 5/2015 Long D28/7
 D741,963 S * 10/2015 Baumann D21/688
 D748,321 S * 1/2016 Grimm D26/128
 D753,253 S * 4/2016 Chiu D21/688
 9,311,903 B1 * 4/2016 Balatti G10D 3/18
 2005/0016355 A1 * 1/2005 Huang G10D 3/18
 84/328
 2005/0120860 A1 * 6/2005 Chen G10D 3/18
 84/328
 2005/0282691 A1 * 12/2005 Hakooz A63B 22/0056
 482/148
 2006/0174743 A1 * 8/2006 Clemente G10D 3/18
 84/279
 2008/0196570 A1 * 8/2008 Cheng G10D 3/18
 84/280
 2009/0211426 A1 * 8/2009 Penic G10D 3/18
 84/280
 2010/0242703 A1 * 9/2010 Ruan G10D 3/18
 84/280
 2013/0125728 A1 * 5/2013 Korfker G10D 3/18
 84/280
 2013/0276611 A1 * 10/2013 Vochezer G10G 5/005
 84/280
 2014/0090539 A1 * 4/2014 Korfker G10D 3/18
 84/280
 2014/0290460 A1 * 10/2014 Vochezer G10D 3/18
 84/280
 2015/0187342 A1 * 7/2015 Stern G10D 3/18
 84/280

(56)

References Cited

U.S. PATENT DOCUMENTS

2015/0348520 A1* 12/2015 Tang G10D 3/18
84/279

OTHER PUBLICATIONS

Tasset violin shoulder rest, image post date 2000, site visited Feb. 7, 2016, (online), <<http://www.free-scores.com/buy/epauliere-johnson-pour-violon-taille-119178>>.*

Adjustable Violin Shoulder Rest, image post date 2004, site visited Feb. 7, 2016, (online), <<http://www.dhgate.com/store/product/adjustable-violin-shoulder-rest-for-3-4-4/235316597.html>>.*

Unpublished Design U.S. Appl. No. 29/519,748, filed Mar. 6, 2015.

Unpublished Design U.S. Appl. No. 29/519,755, filed Mar. 6, 2015.

Unpublished Design U.S. Appl. No. 29/519,756, filed Mar. 6, 2015.

Unpublished Utility U.S. Appl. No. 14/535,178, filed Nov. 6, 2014.

* cited by examiner

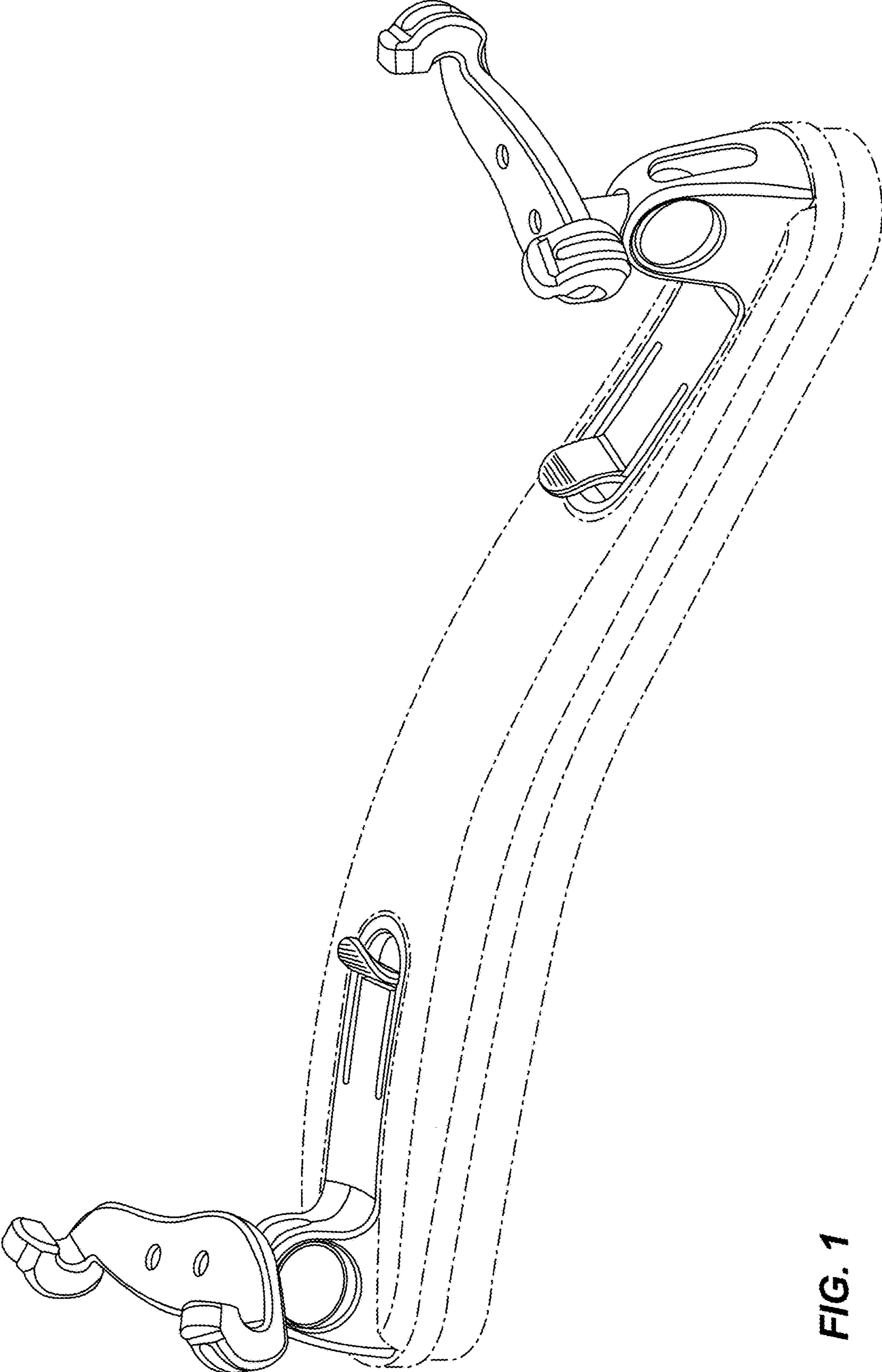

FIG. 1

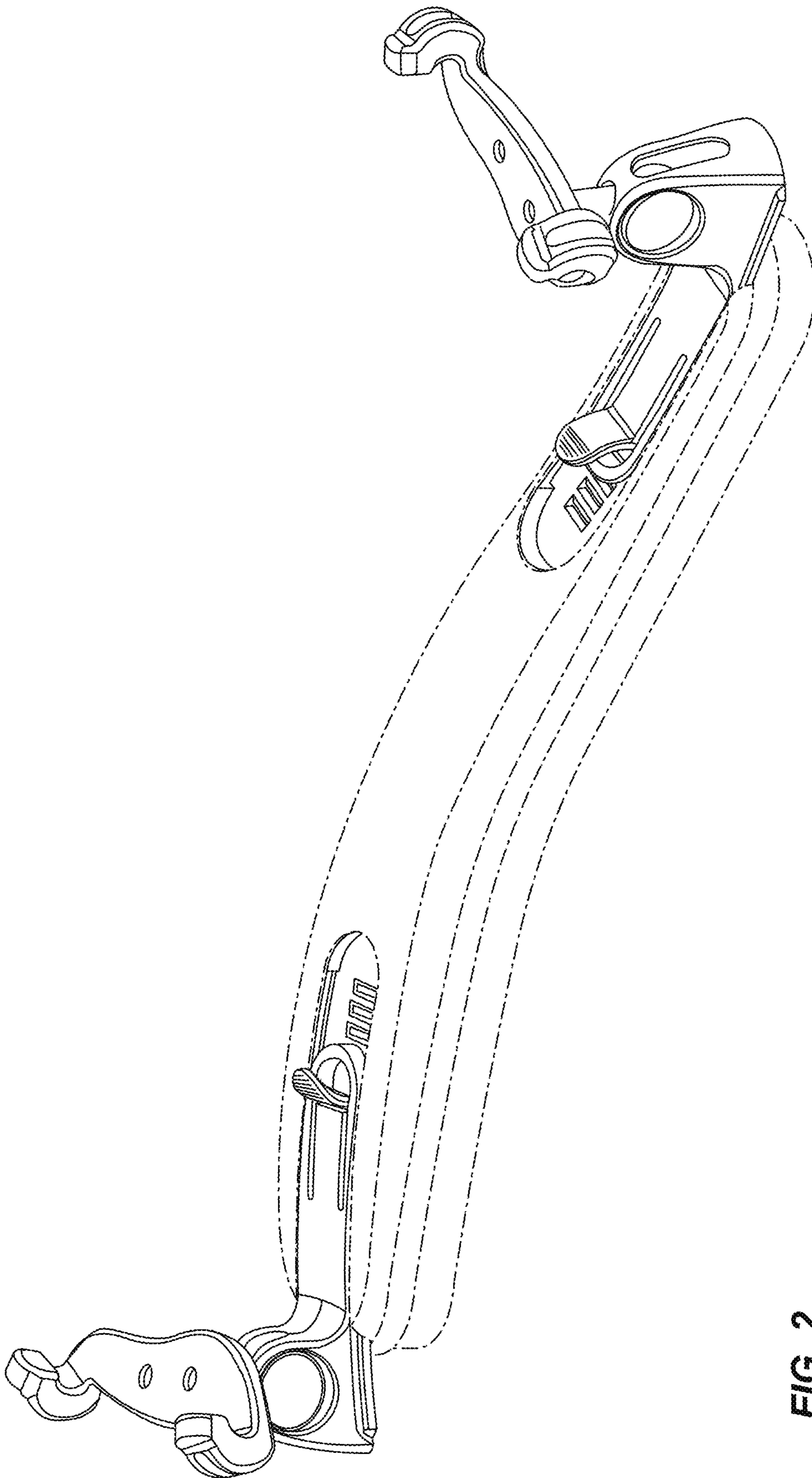

FIG. 2

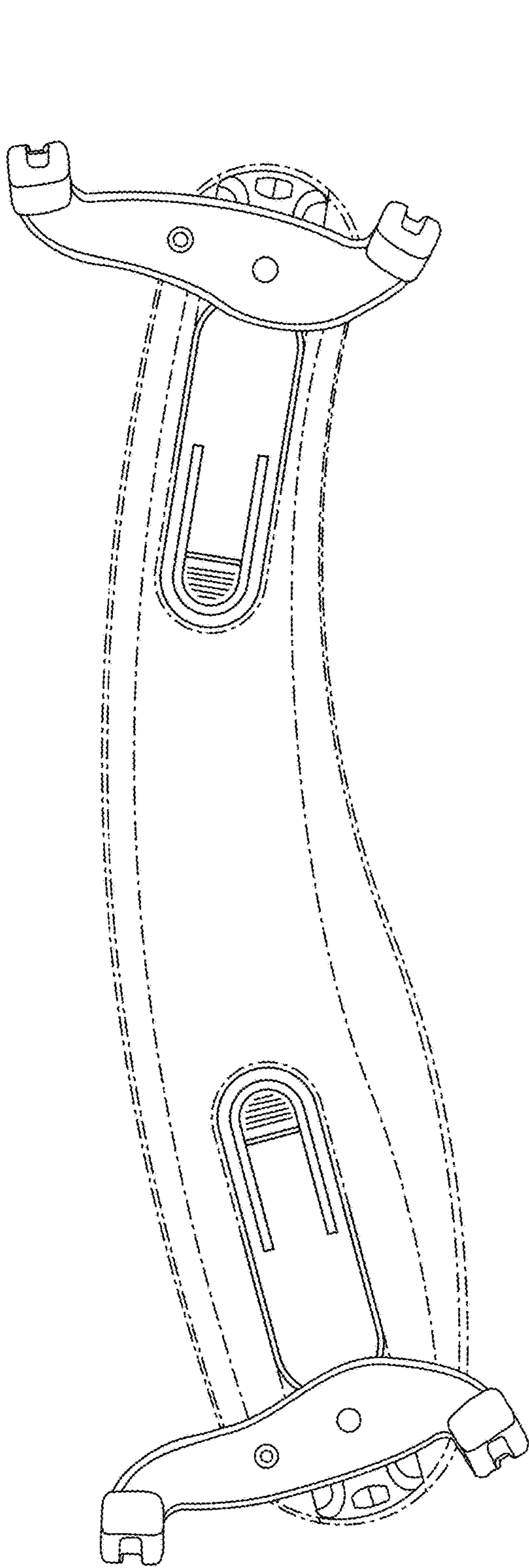

FIG. 3

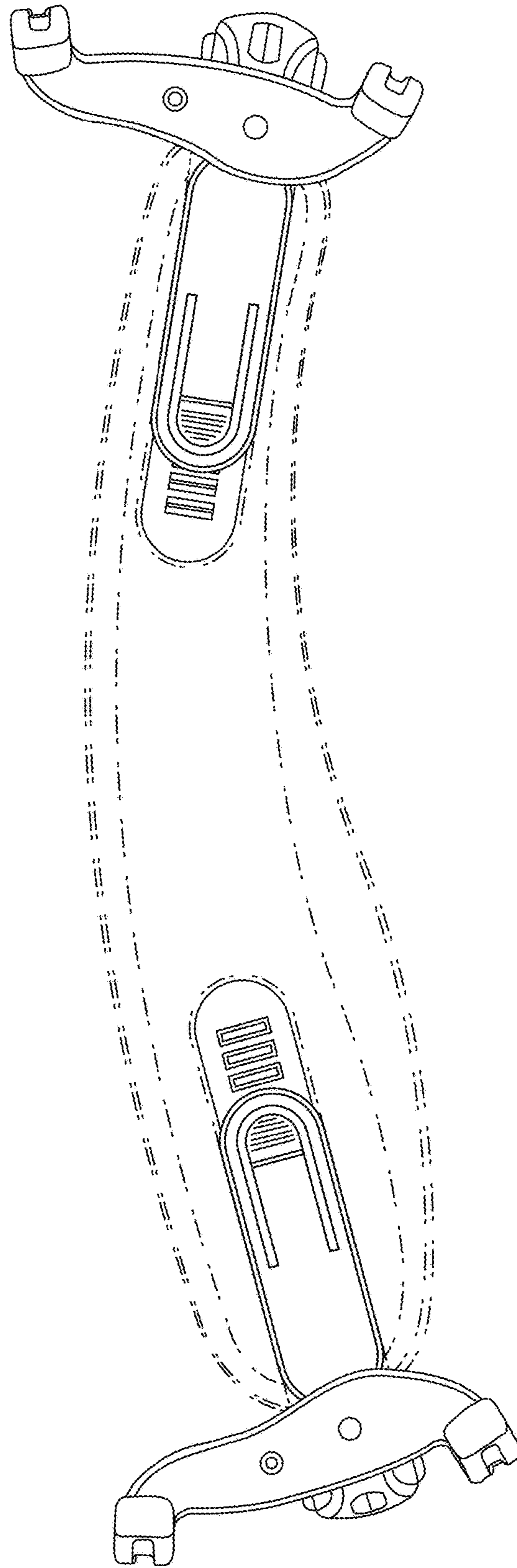

FIG. 4

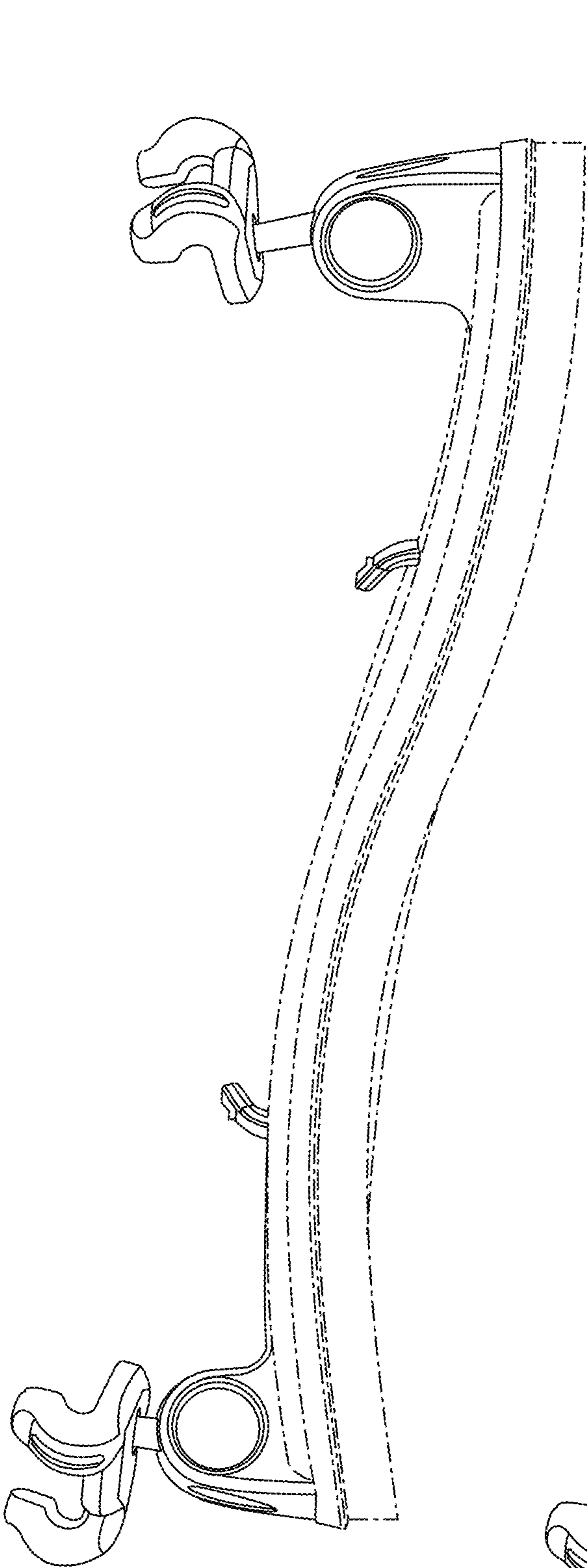

FIG. 5

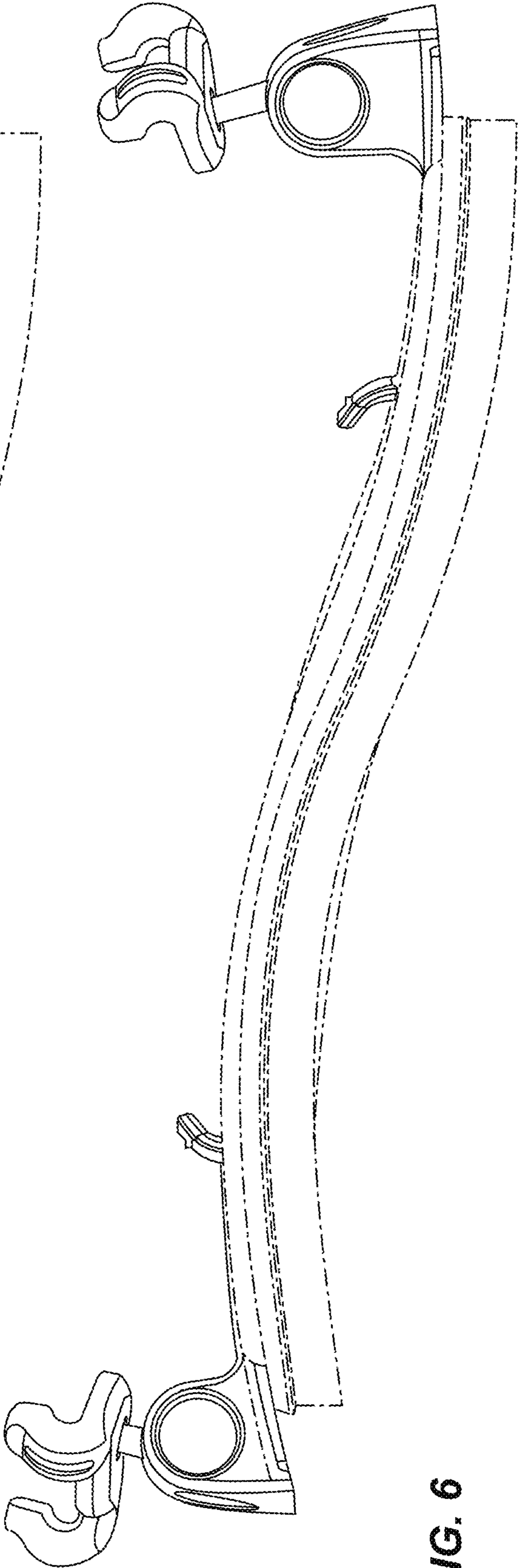

FIG. 6

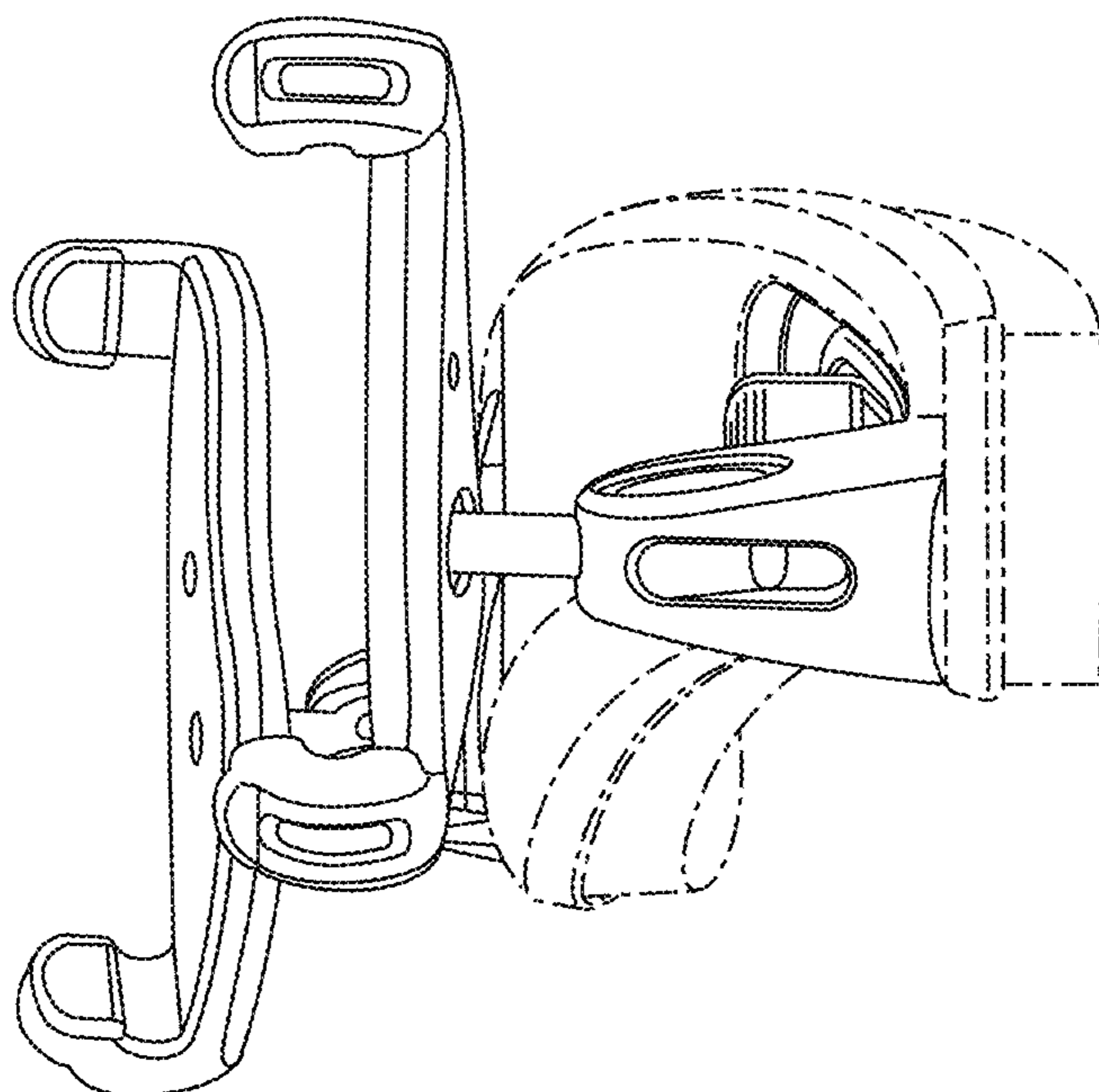

FIG. 8

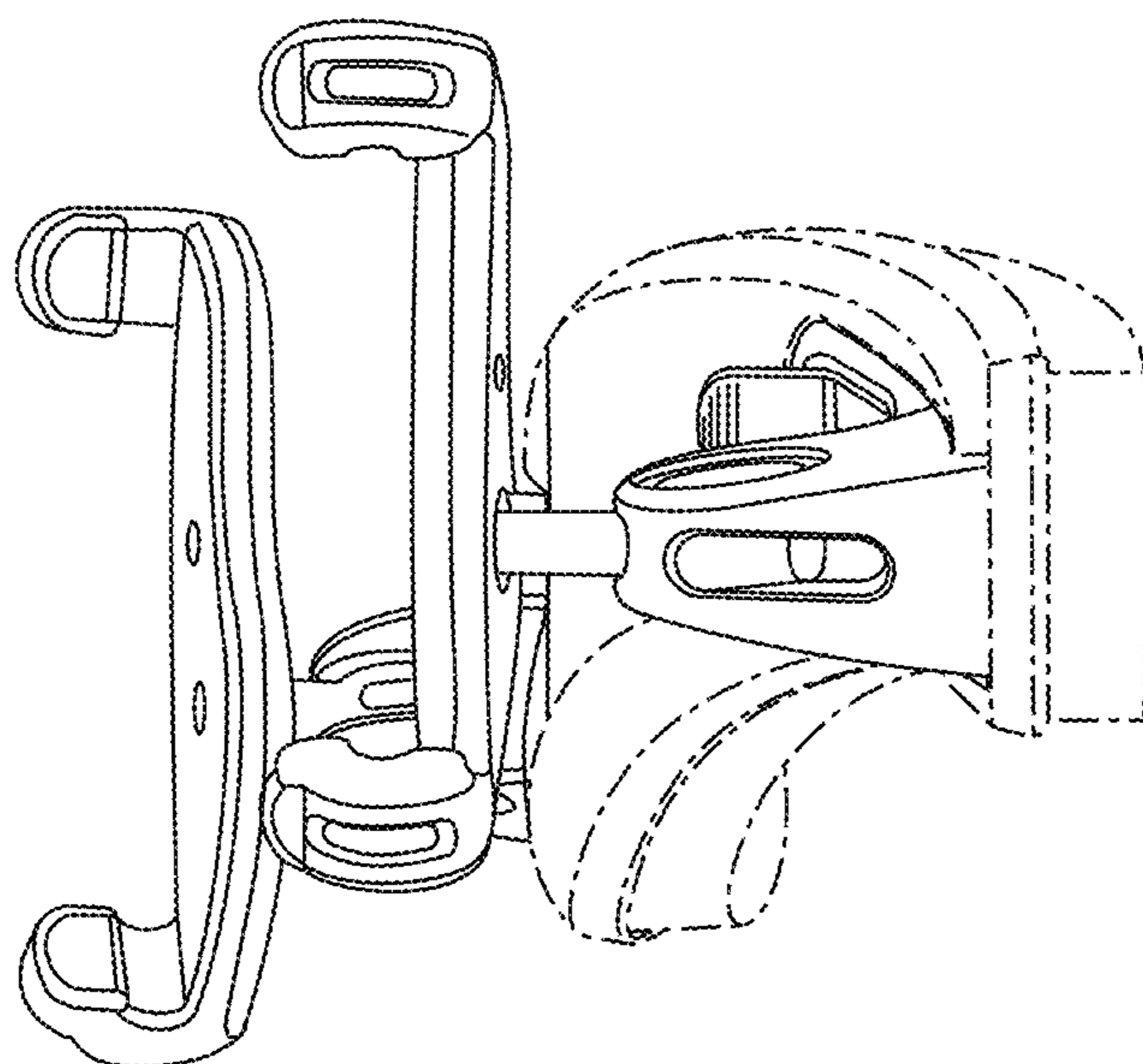

FIG. 7

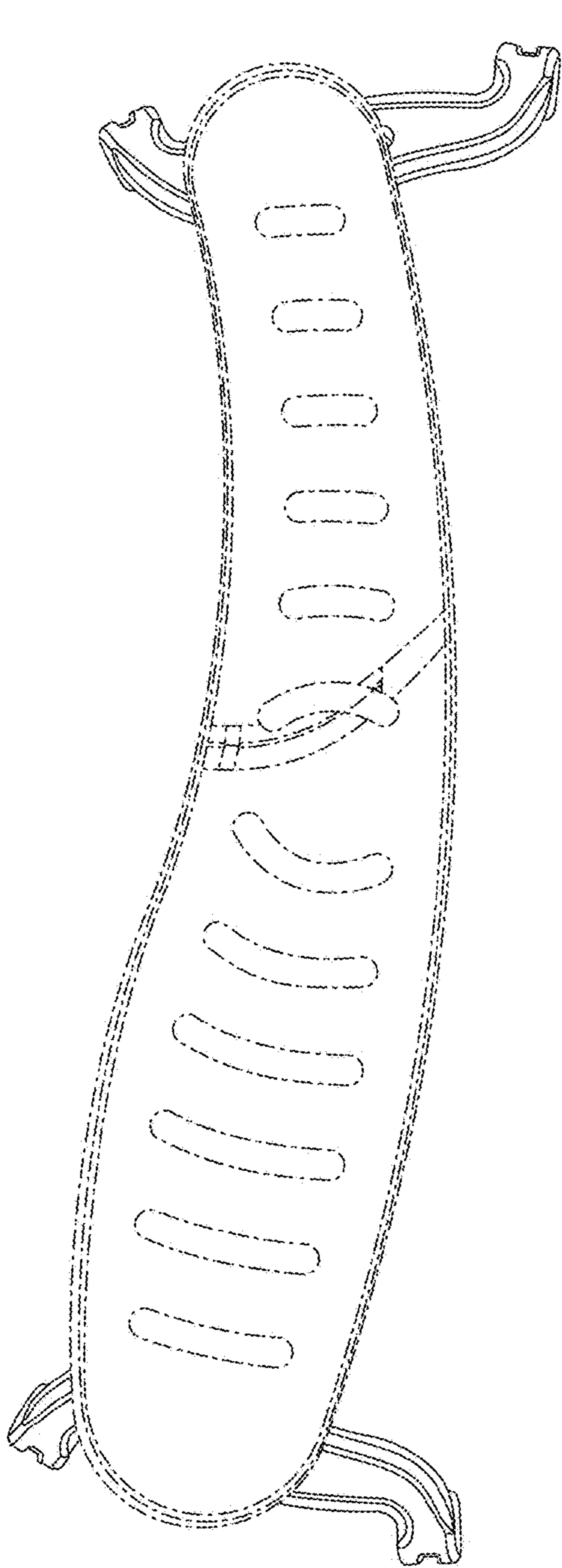

FIG. 9

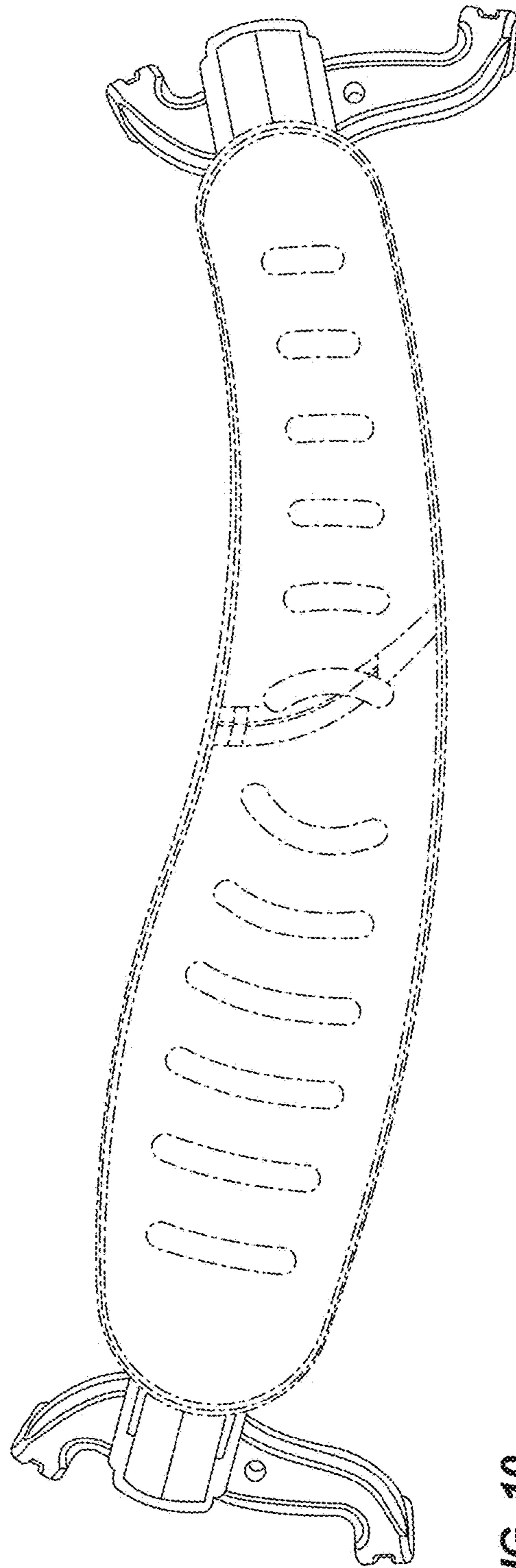

FIG. 10

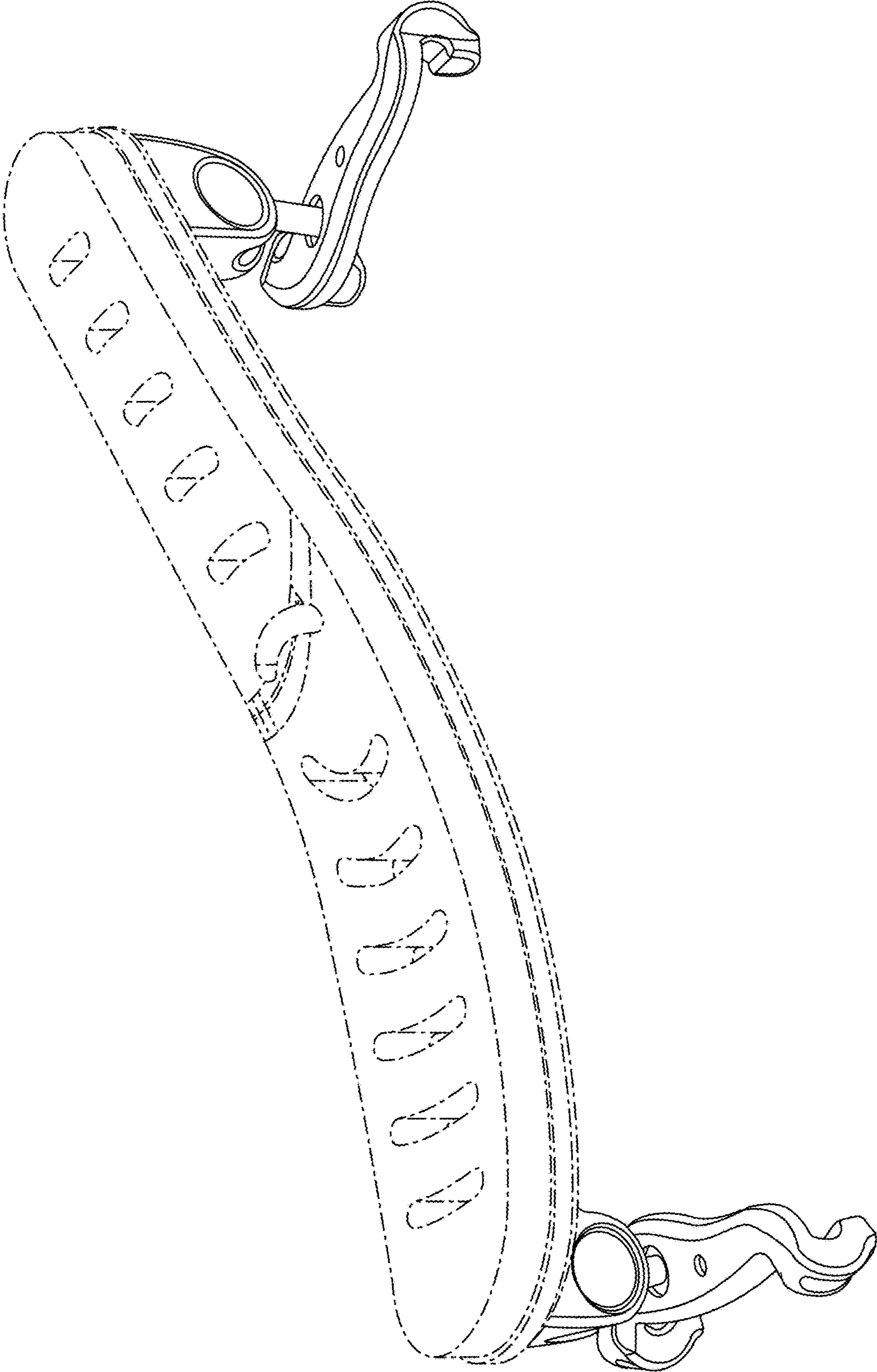

FIG. 11

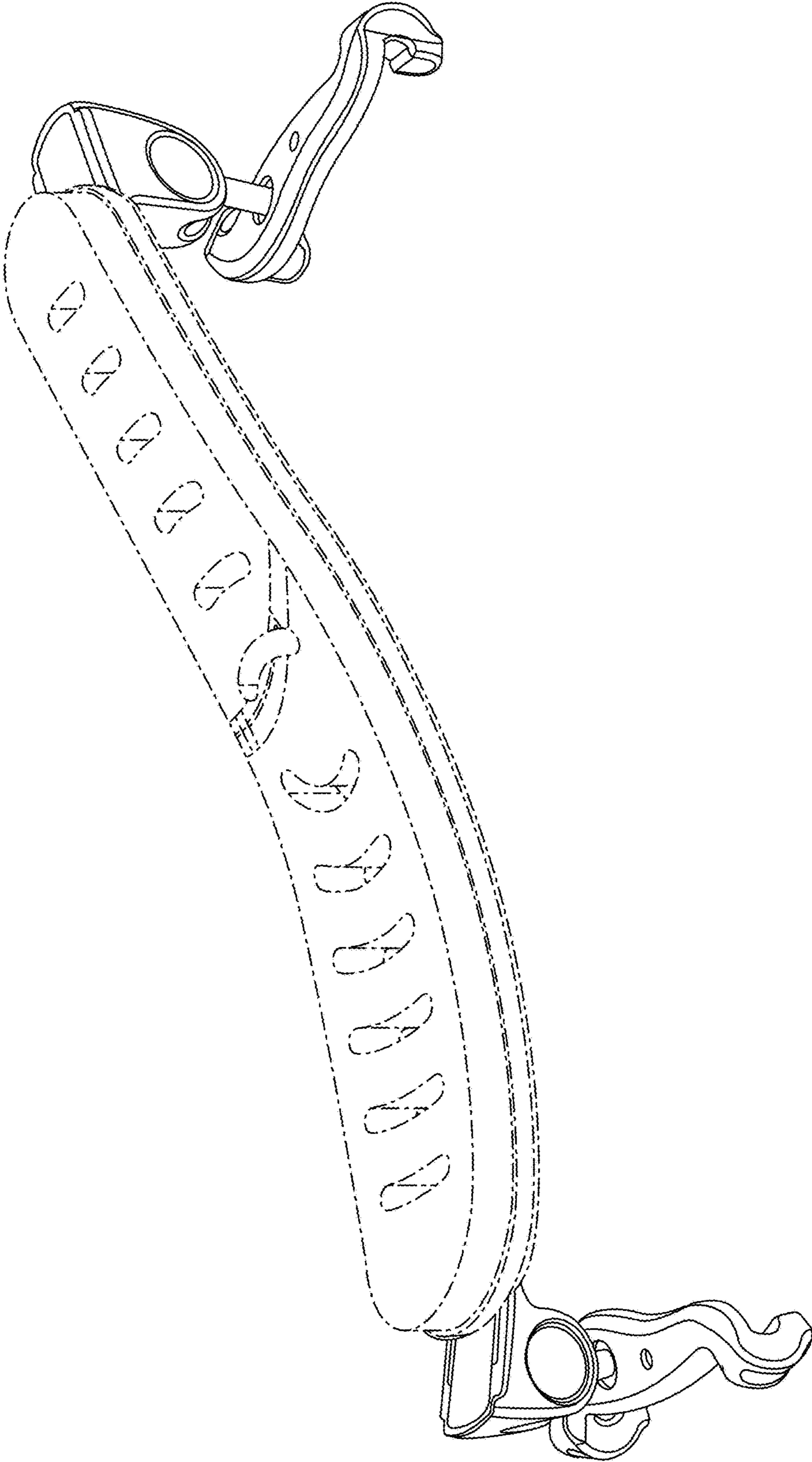

FIG. 12

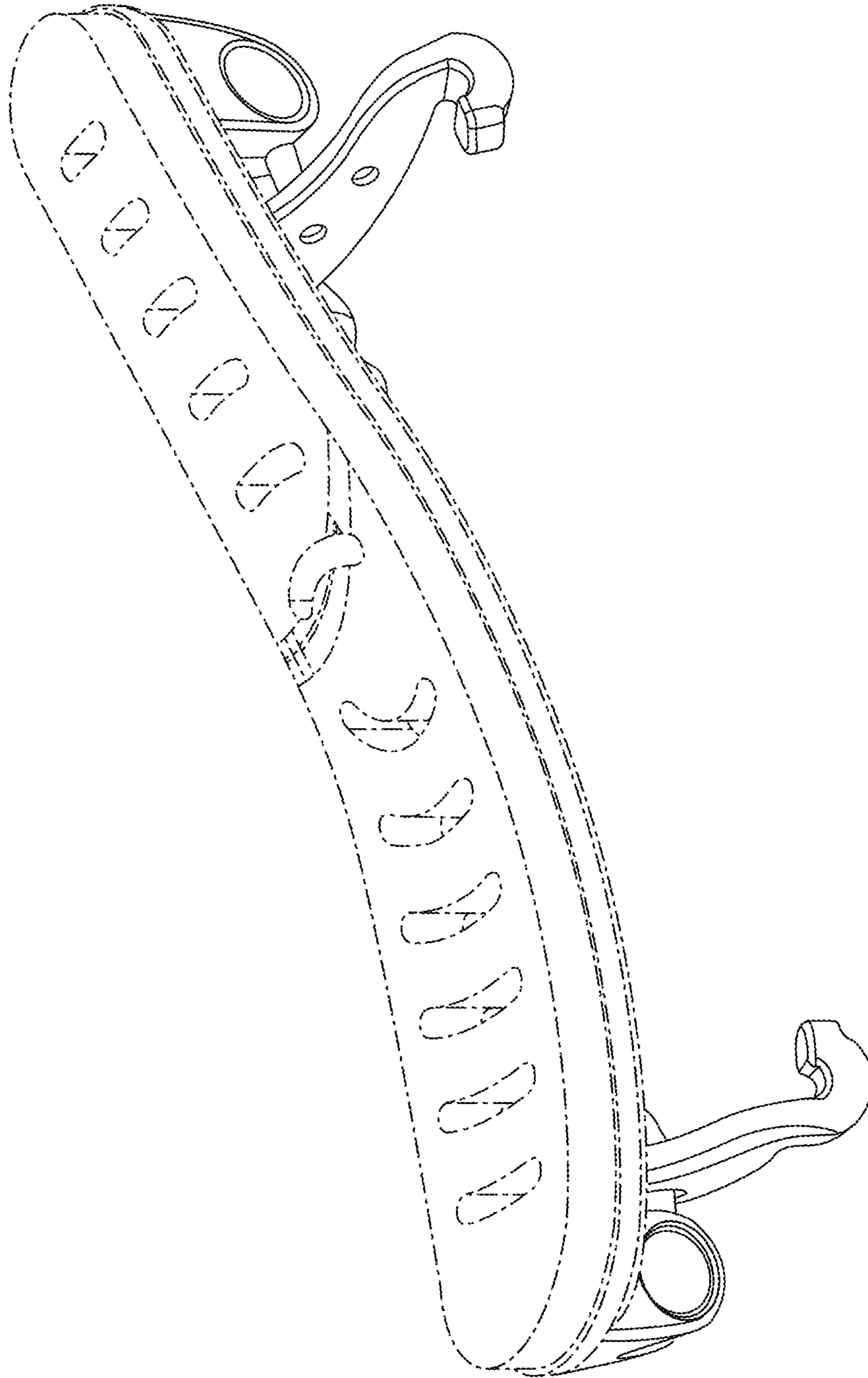

FIG. 13

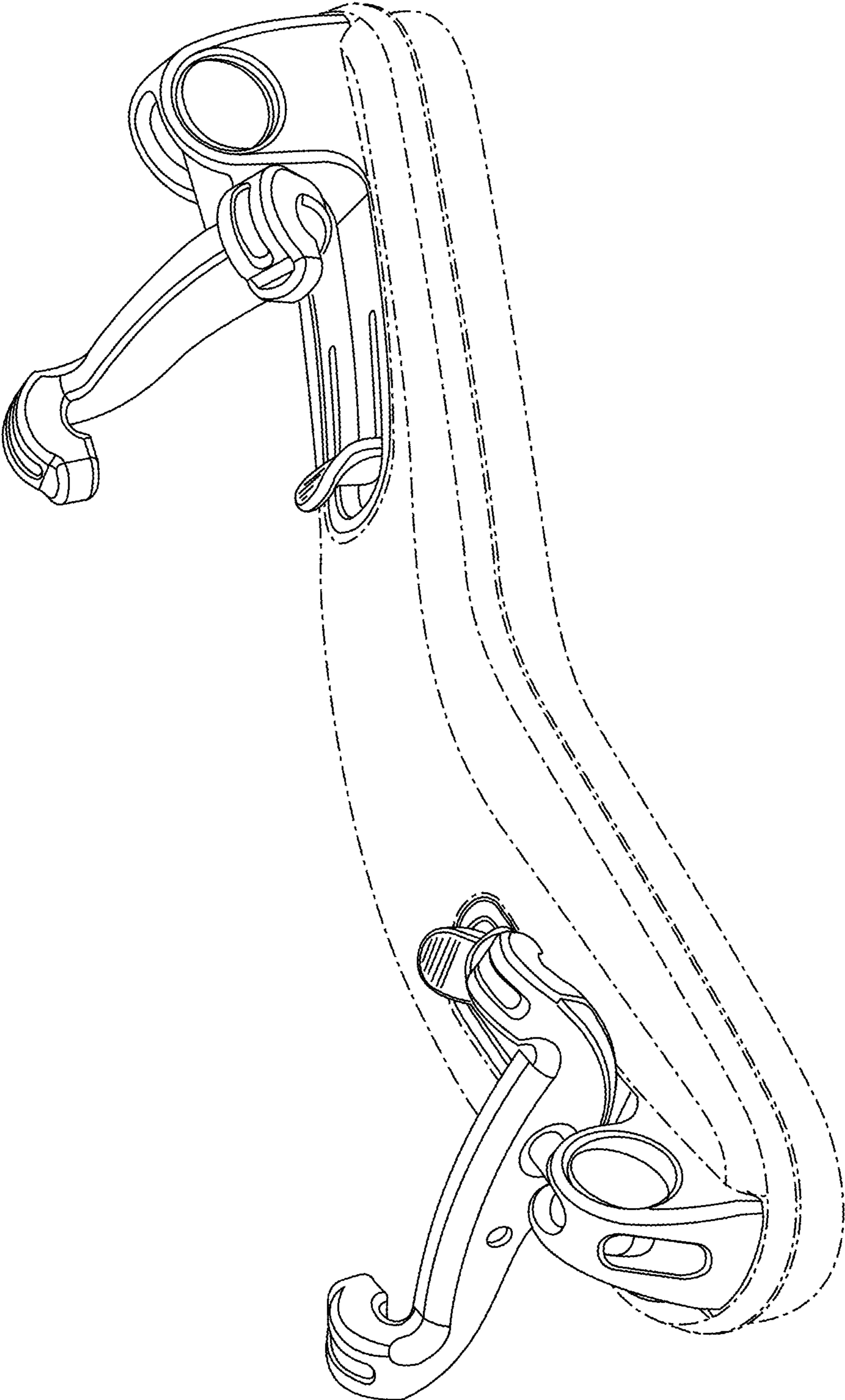

FIG. 14

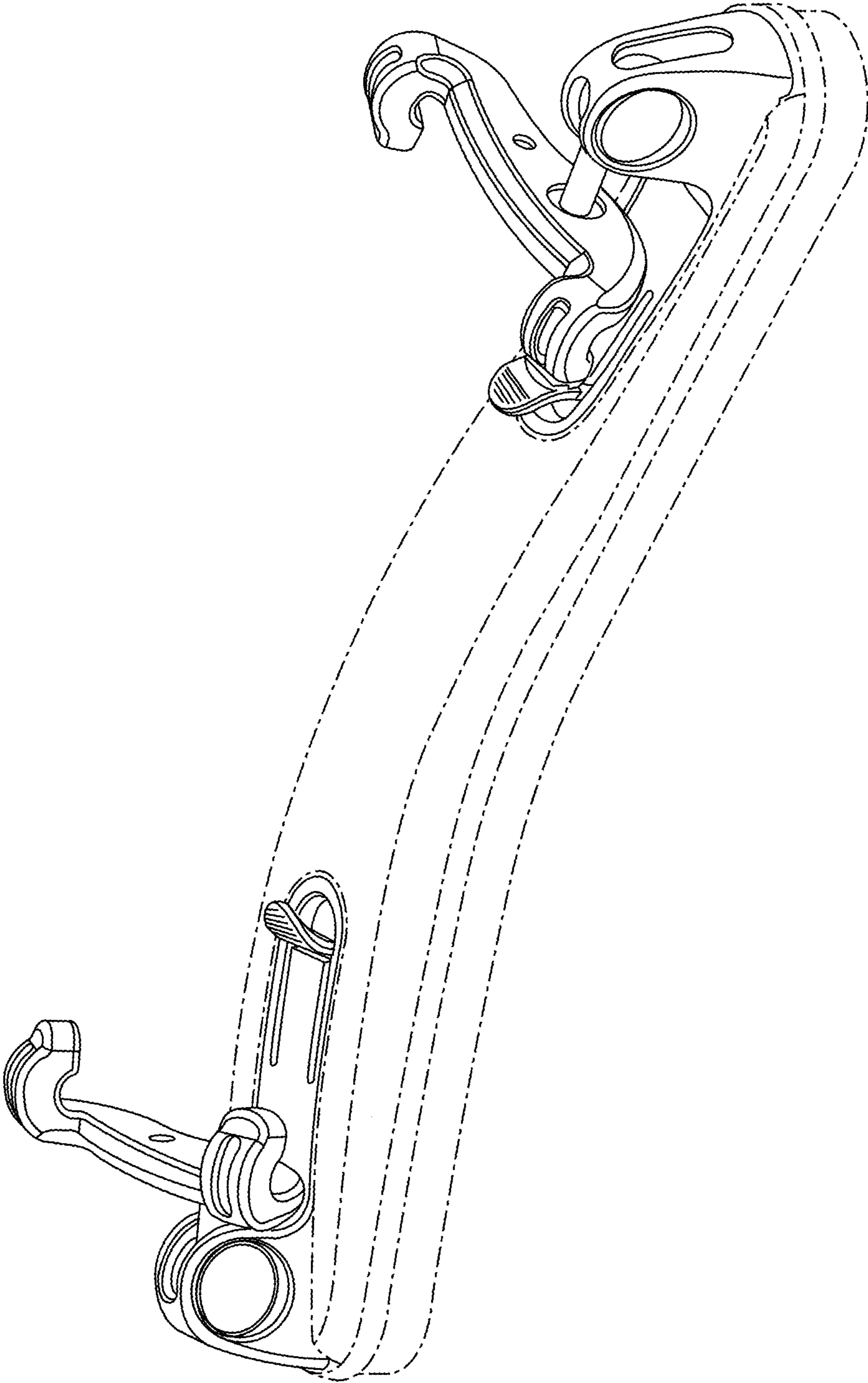

FIG. 15