



US00D793342S

(12) **United States Design Patent** (10) **Patent No.:** **US D793,342 S**
Ashibu (45) **Date of Patent:** **** Aug. 1, 2017**

(54) **ELECTRICAL CONNECTOR**

(71) Applicant: **JAPAN AVIATION ELECTRONICS INDUSTRY, LIMITED**, Tokyo (JP)

(72) Inventor: **Kenta Ashibu**, Tokyo (JP)

(73) Assignee: **Japam Aviation Electronics Industry, Limited**, Tokyo (JP)

(**) Term: **15 Years**

(21) Appl. No.: **29/578,240**

(22) Filed: **Sep. 20, 2016**

(30) **Foreign Application Priority Data**

Apr. 5, 2016 (JP) 2016-007538

(51) **LOC (10) Cl.** **13-03**

(52) **U.S. Cl.**
USPC **D13/147**

(58) **Field of Classification Search**
 USPC D13/120, 133, 146, 147, 154, 184, 199;
 D14/432, 433, 435, 435.1, 436, 437, 438
 CPC H01R 12/51; H01R 12/52; H01R 12/592;
 H01R 12/61; H01R 12/70; H01R
 12/7005; H01R 12/71; H01R 12/72;
 H01R 12/73; H01R 12/732; H01R
 12/737; H01R 12/77; H01R 12/774;
 H01R 12/777; H01R 12/778; H01R
 12/79; H01R 13/516

See application file for complete search history.

(56) **References Cited**

U.S. PATENT DOCUMENTS

D642,535 S *	8/2011	Sato	D13/147
D683,317 S	5/2013	Nishimura et al.	
D684,120 S *	6/2013	Miyazaki	D13/147
D688,210 S *	8/2013	Mashiyama	D13/147
D695,691 S	12/2013	Kobuchi et al.	
D720,298 S *	12/2014	Takenaga	D13/147
D721,040 S *	1/2015	Watanabe	D13/147
D735,674 S *	8/2015	Miyazaki	D13/147
D774,463 S *	12/2016	Omodachi	D13/147
D774,464 S *	12/2016	Takenaga	D13/147

* cited by examiner

Primary Examiner — Daniel Bui

(74) *Attorney, Agent, or Firm* — Cermak Nakajima & McGowan LLP; Tomoko Nakajima

(57) **CLAIM**

The ornamental design for an electrical connector, as shown.

DESCRIPTION

FIG. 1 is a front elevational view of an electrical connector showing my new design;
 FIG. 2 is a top plan view thereof;
 FIG. 3 is a right side elevational view thereof;
 FIG. 4 is a left side elevational view thereof;
 FIG. 5 is a rear elevational view thereof; and
 FIG. 6 is a bottom plan view thereof.
 FIG. 7 is a top perspective view thereof; and
 FIG. 8 is a bottom perspective view thereof; and,
 FIG. 9 is a reference cross sectional view thereof taken along the line A-A shown in FIG. 2.

1 Claim, 9 Drawing Sheets

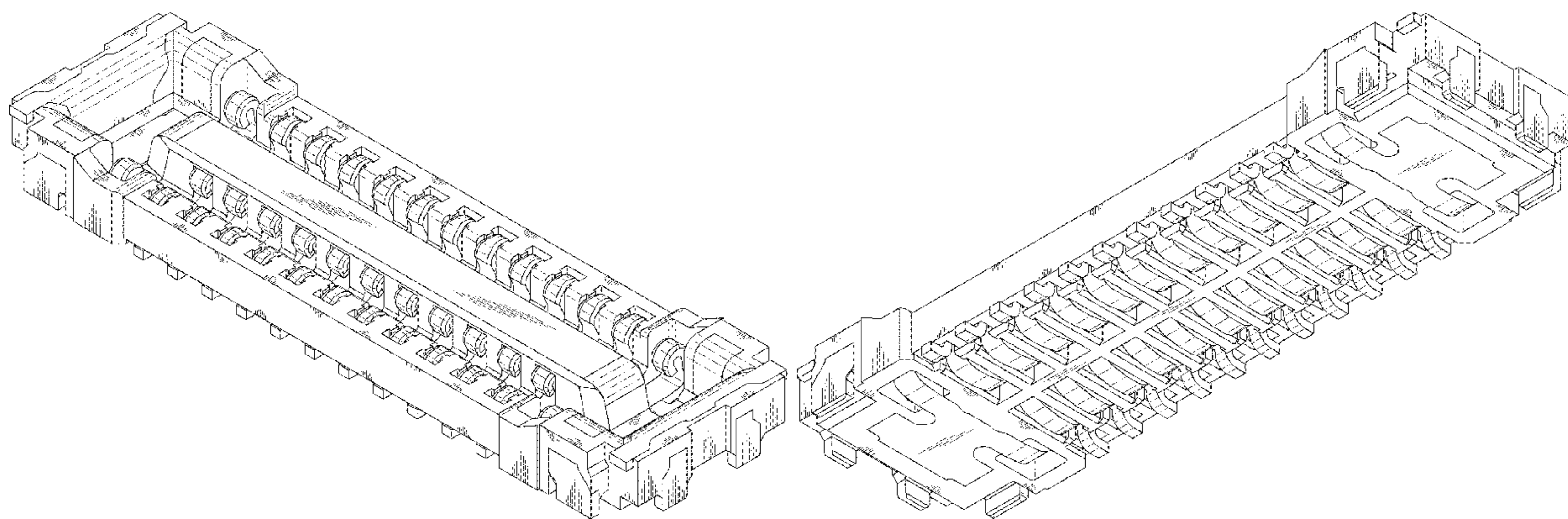

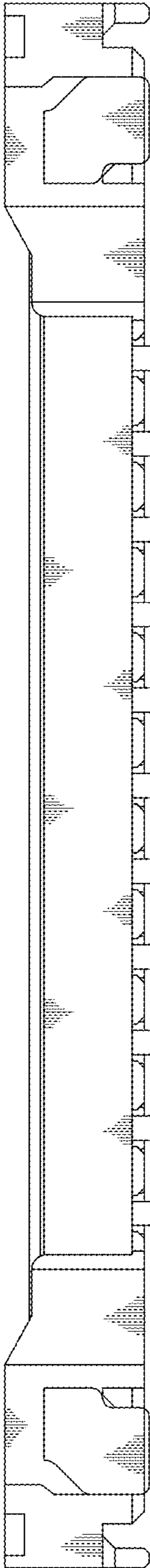

FIG.1

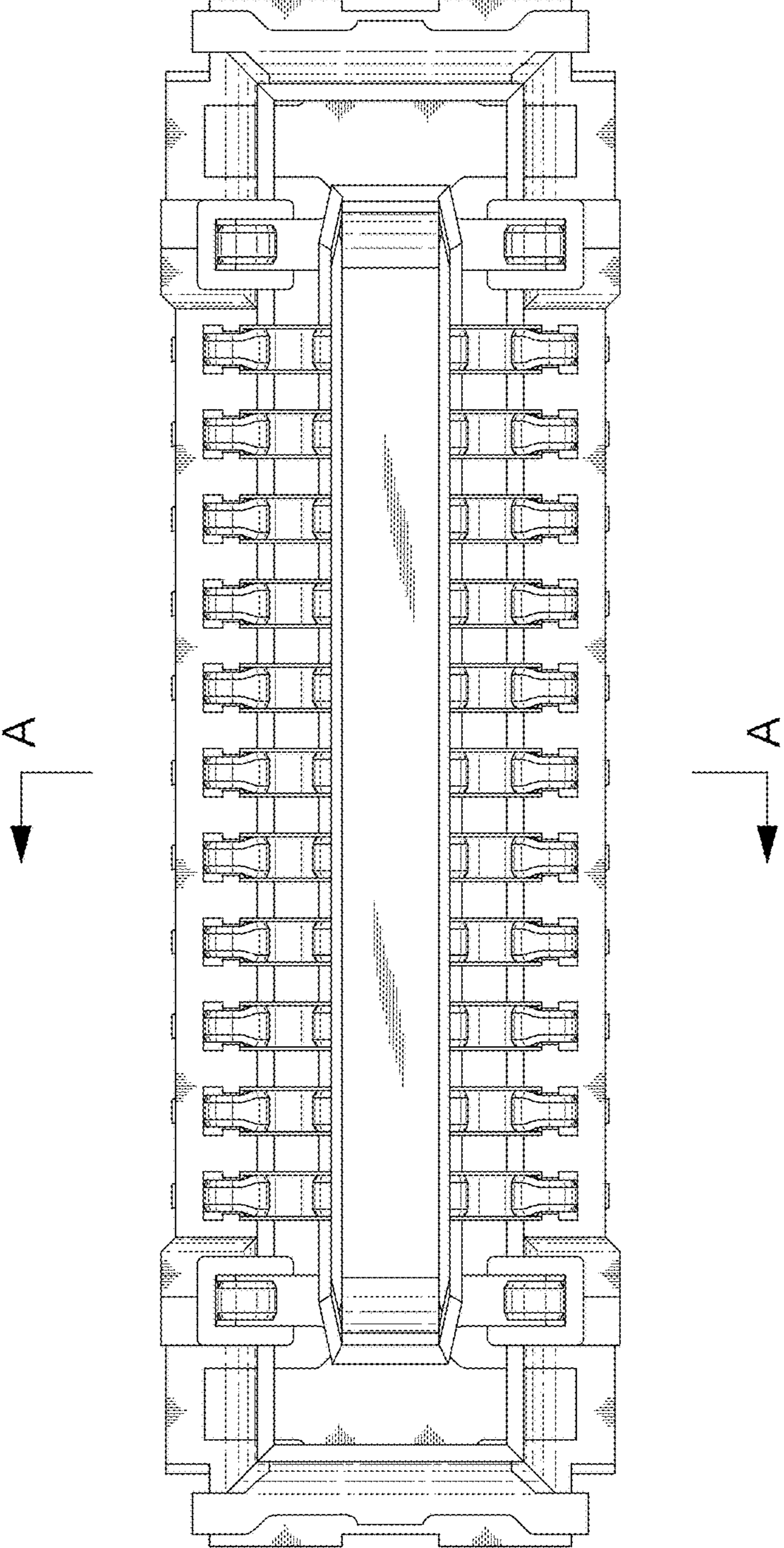

FIG.2

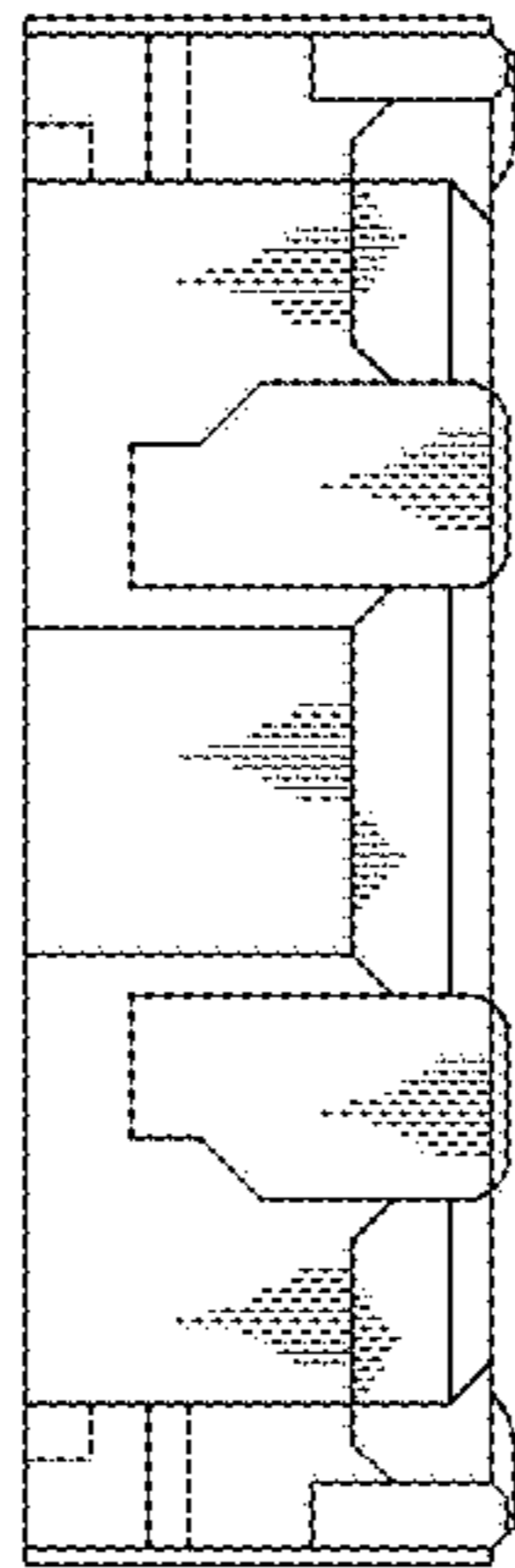

FIG.3

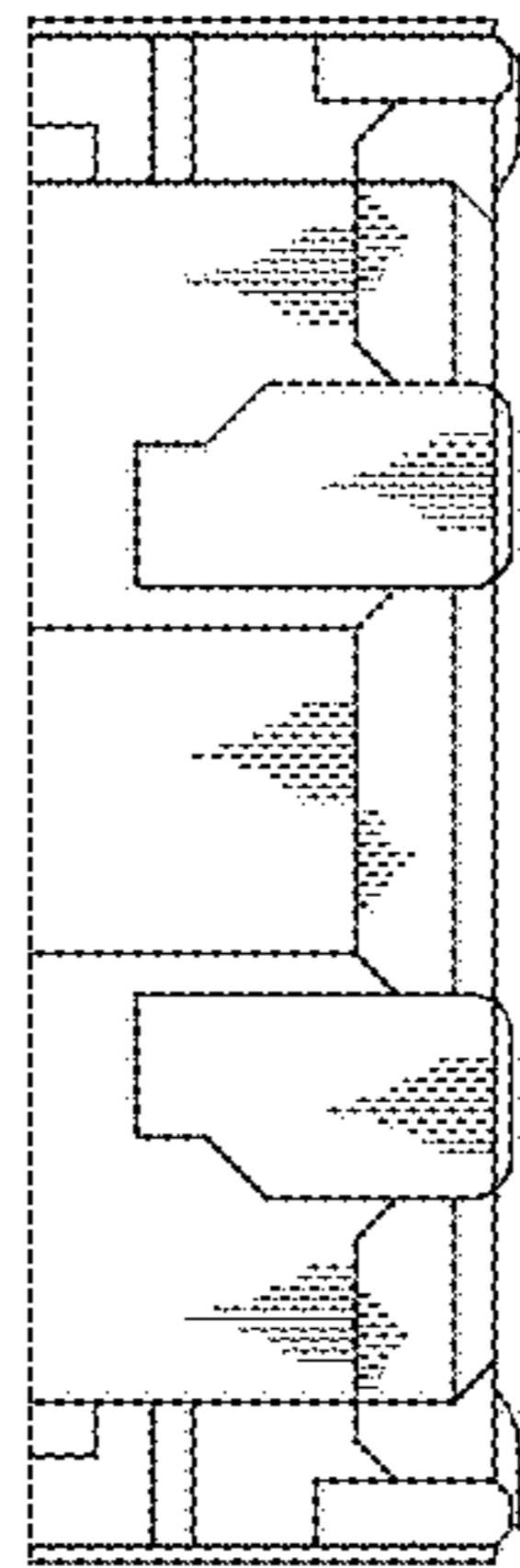

FIG.4

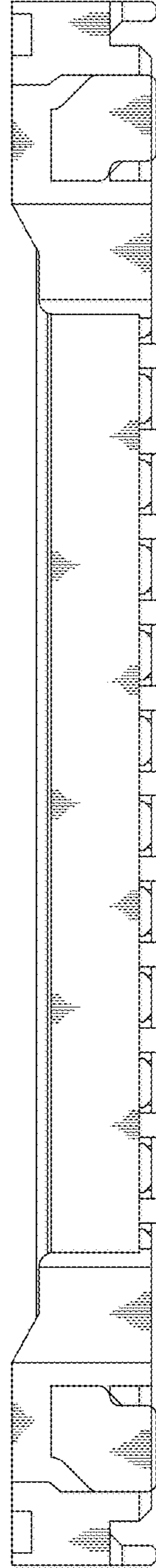

FIG.5

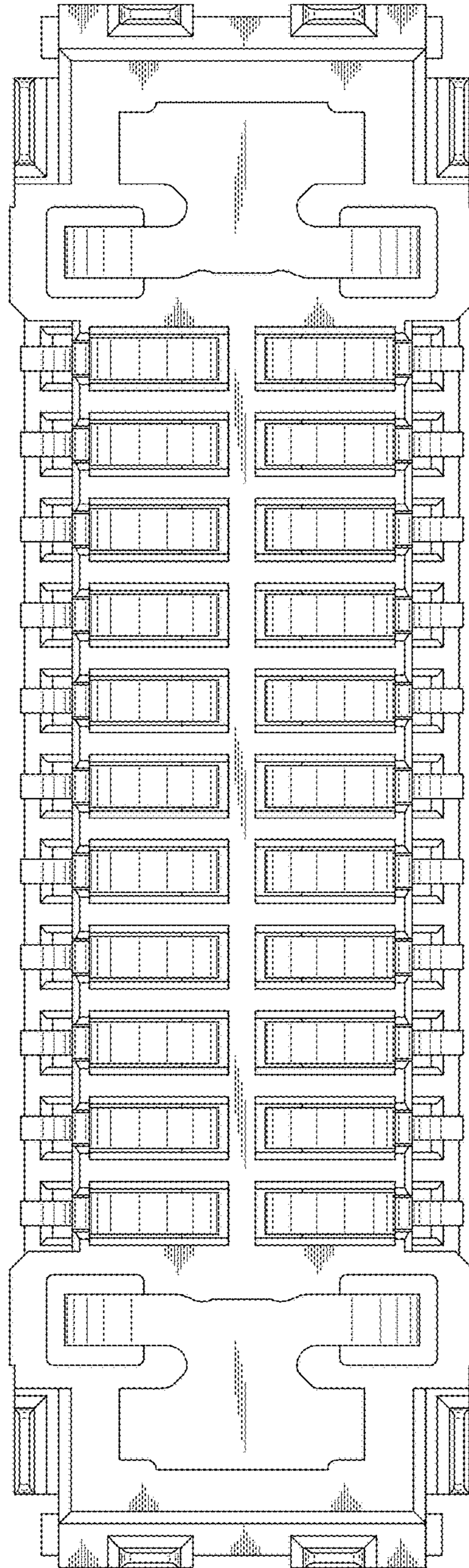

FIG.6

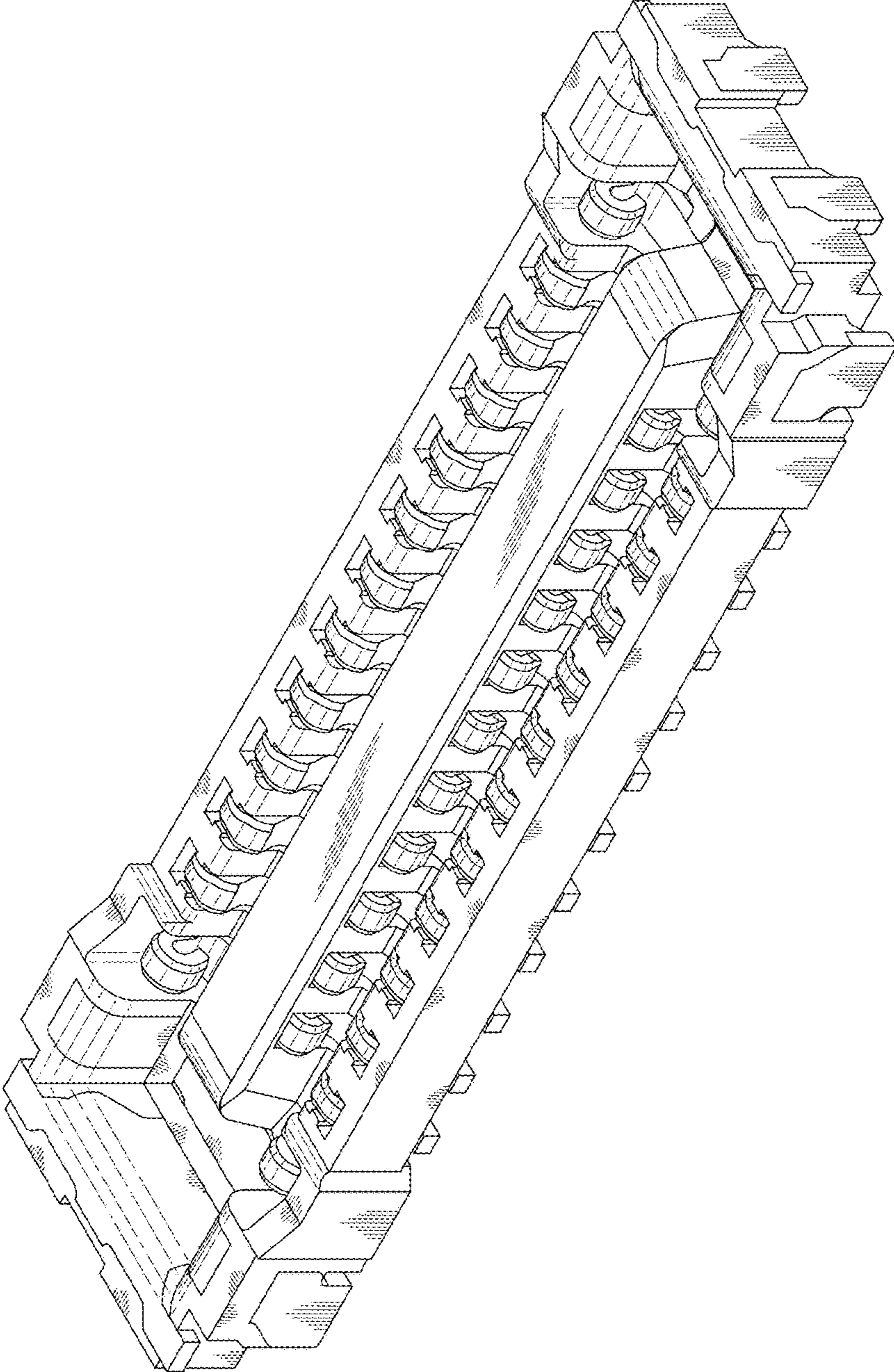

FIG.7

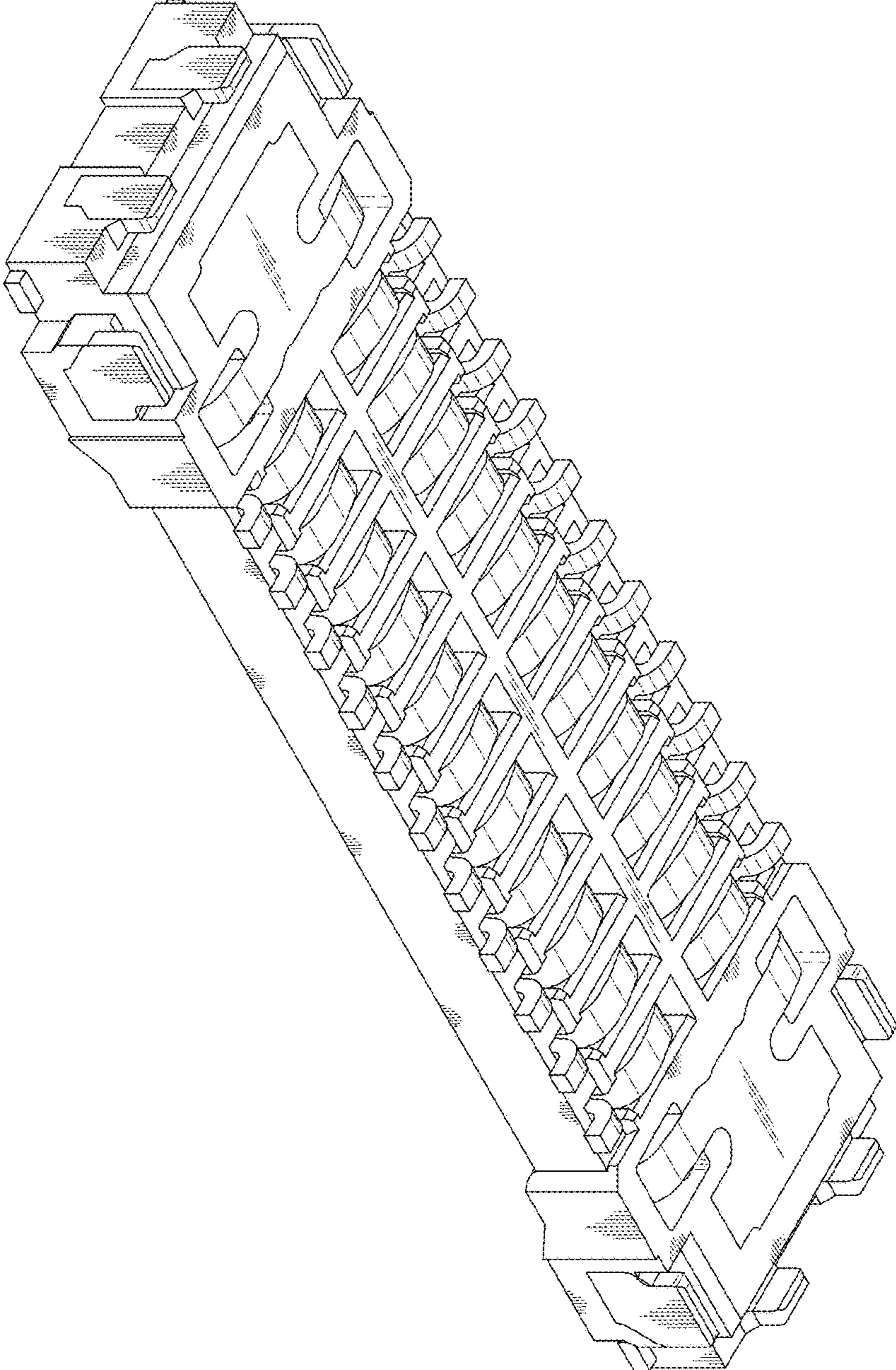

FIG.8

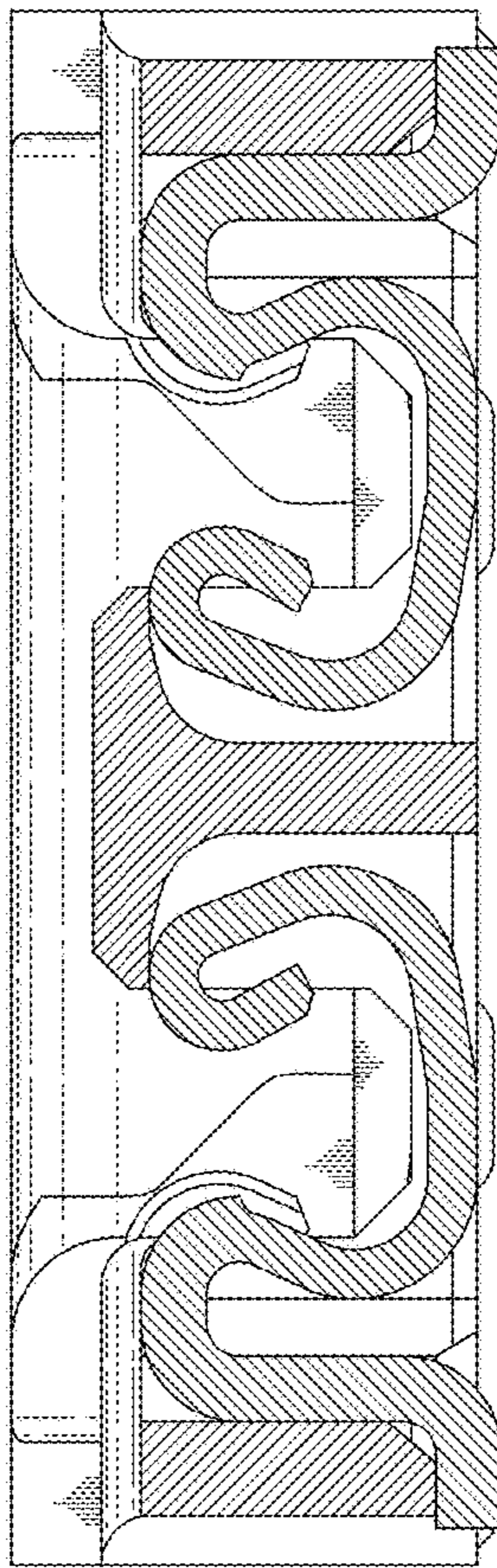

FIG.9