



US00D793206S

(12) **United States Design Patent**
Shenkerman

(10) **Patent No.:** **US D793,206 S**
(45) **Date of Patent:** **** Aug. 1, 2017**

- (54) **FOLDABLE BICYCLE LOCK**
- (71) Applicant: **Michael Shenkerman**, Rishpon (IL)
- (72) Inventor: **Michael Shenkerman**, Rishpon (IL)
- (73) Assignee: **Ino Vision Ltd.**, Herzliya (IL)
- (**) Term: **15 Years**
- (21) Appl. No.: **29/567,345**
- (22) Filed: **Jun. 8, 2016**
- (51) **LOC (10) Cl.** **08-07**
- (52) **U.S. Cl.**
USPC **D8/336; D8/331**
- (58) **Field of Classification Search**
USPC D8/330, 331, 334, 343, 324, 349; 70/14,
70/20, 31, 35, 57, 57.1, 58, 233,
70/237-258, DIG. 37, DIG. 26, 18
CPC .. E05B 71/00; E05B 73/00; B62J 1/00; B62H
5/00; B62H 5/02; B62H 5/14
See application file for complete search history.

- D579,756 S * 11/2008 Hentschel E05B 67/003
D8/331
- 7,581,787 B2 * 9/2009 Livne B62H 5/00
297/201
- D657,657 S * 4/2012 Golling D8/331
- D658,037 S * 4/2012 Golling D8/331
- D660,683 S * 5/2012 Golling D8/324
- D660,684 S * 5/2012 Golling D8/324
- D781,133 S * 3/2017 Heinemann D8/331

* cited by examiner

Primary Examiner — Prabhakar Deshmukh
(74) *Attorney, Agent, or Firm* — Dekel Patent Ltd.; David Klein

- (56) **References Cited**
U.S. PATENT DOCUMENTS
1,892,964 A * 1/1933 Rainey E05B 37/025
70/25
3,747,376 A * 7/1973 White, Jr. B62H 5/003
24/573.09
D402,180 S * 12/1998 Chappell D8/333
5,913,906 A * 6/1999 Strocchi B62H 5/003
59/78
7,437,898 B2 * 10/2008 Su E05B 67/003
70/14

(57) **CLAIM**
The ornamental design for a foldable bicycle lock, as shown and described.

DESCRIPTION
FIG. 1 is a perspective view of a foldable bicycle lock, showing my new design;
FIG. 2 is a front view thereof;
FIG. 3 is a rear view thereof;
FIG. 4 is a top side view thereof;
FIG. 5 is a bottom side view thereof;
FIG. 6 is a left view thereof; and,
FIG. 7 is a right view thereof.
The nature and intended use of the article in which the design is embodied is that of a foldable bicycle lock.

1 Claim, 7 Drawing Sheets

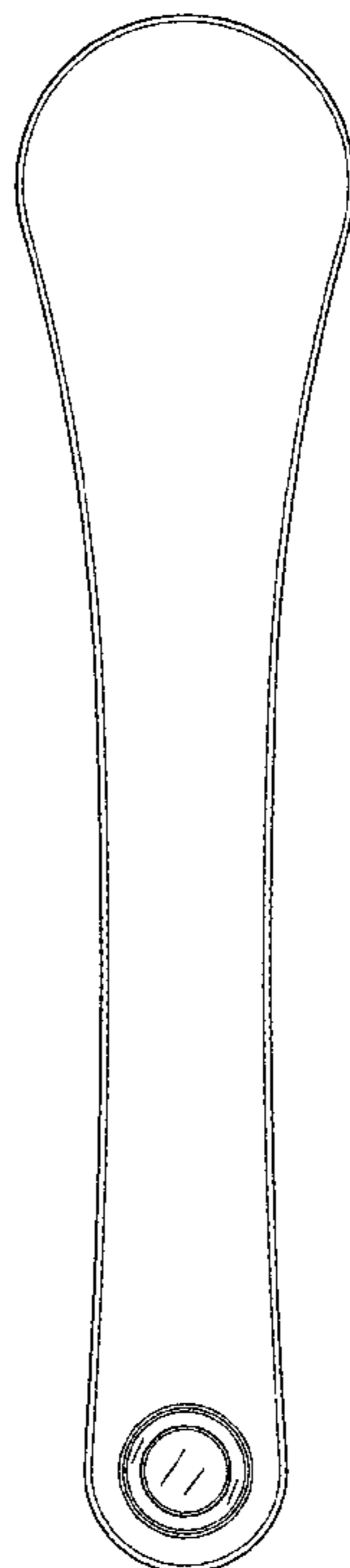

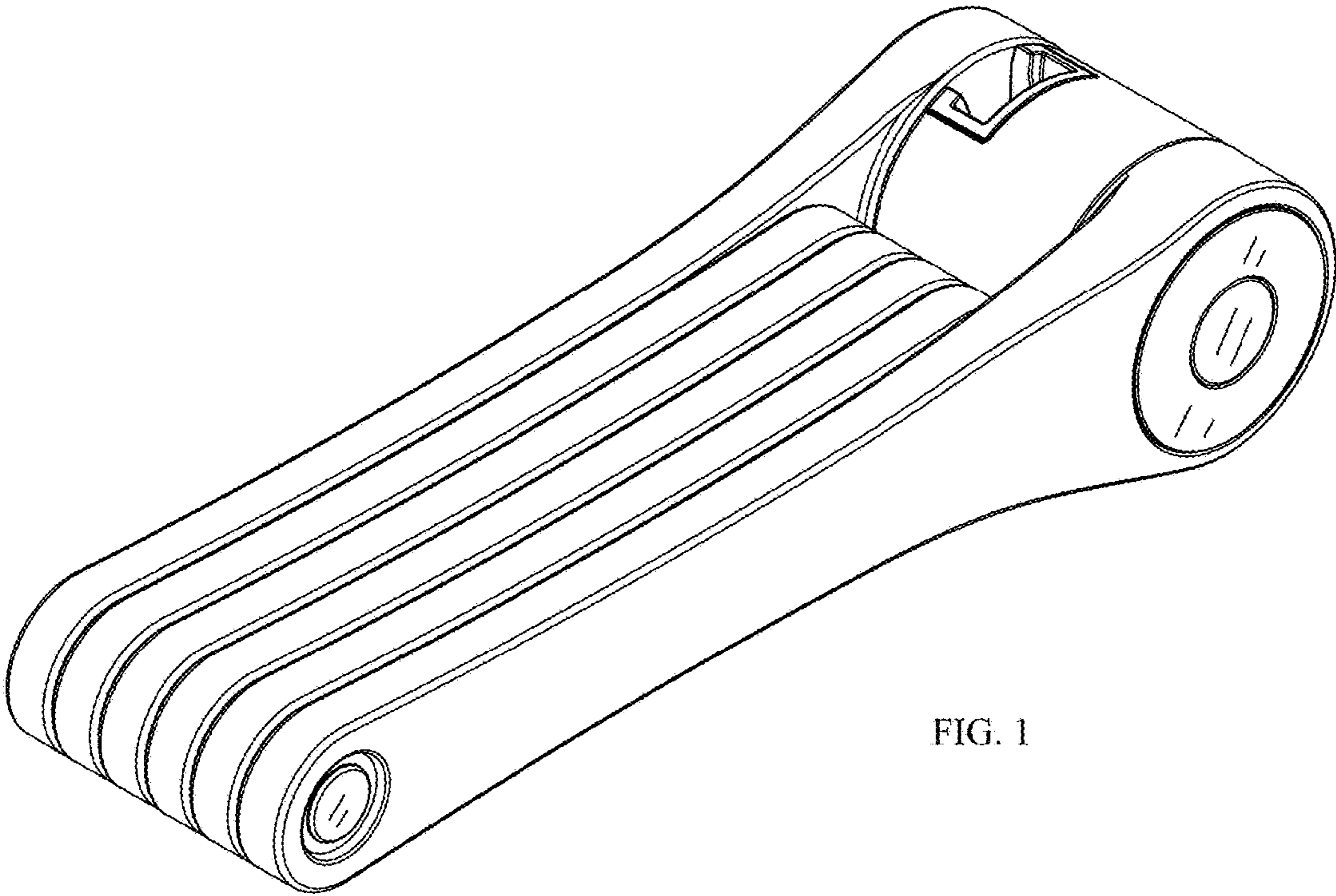

FIG. 1

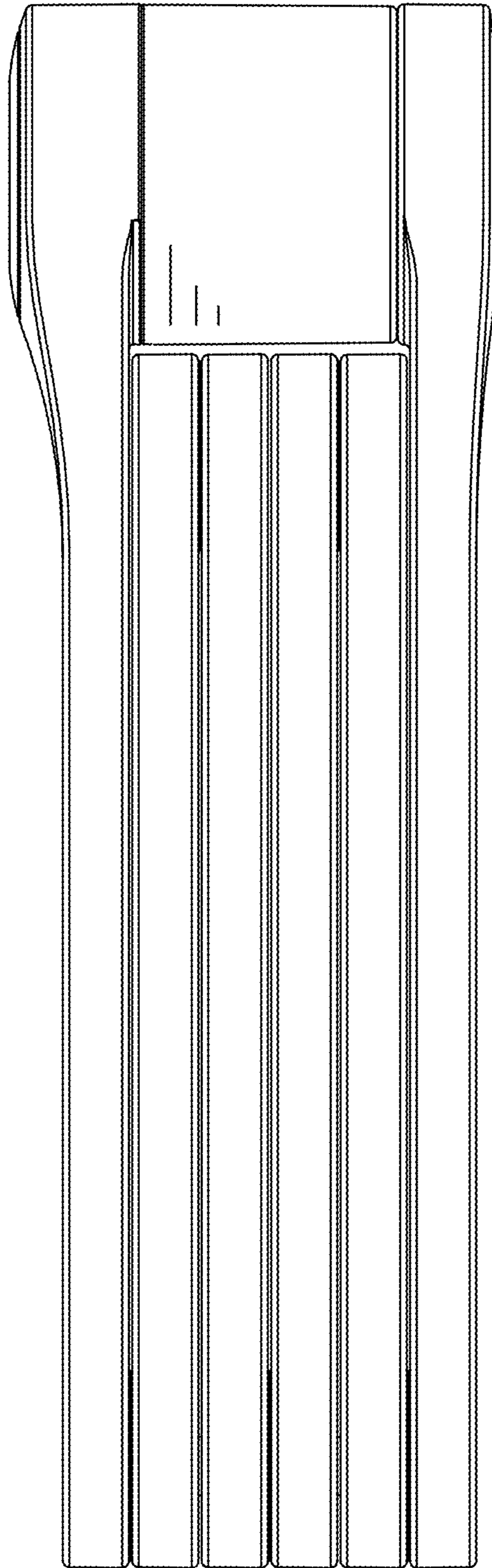

FIG. 2

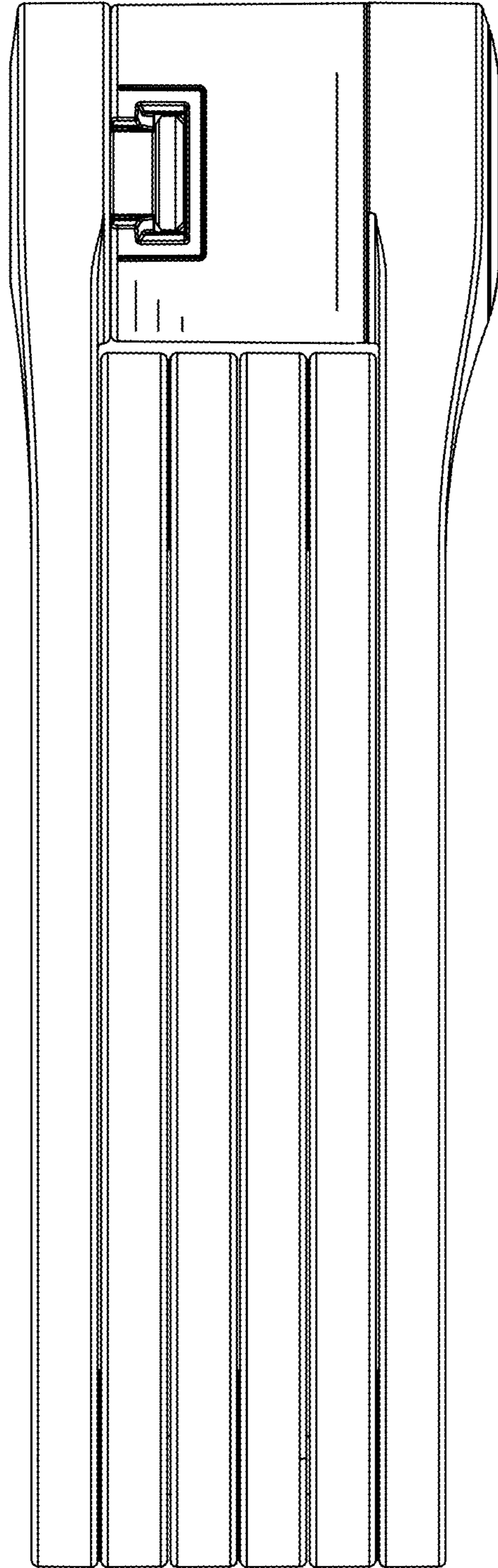

FIG. 3

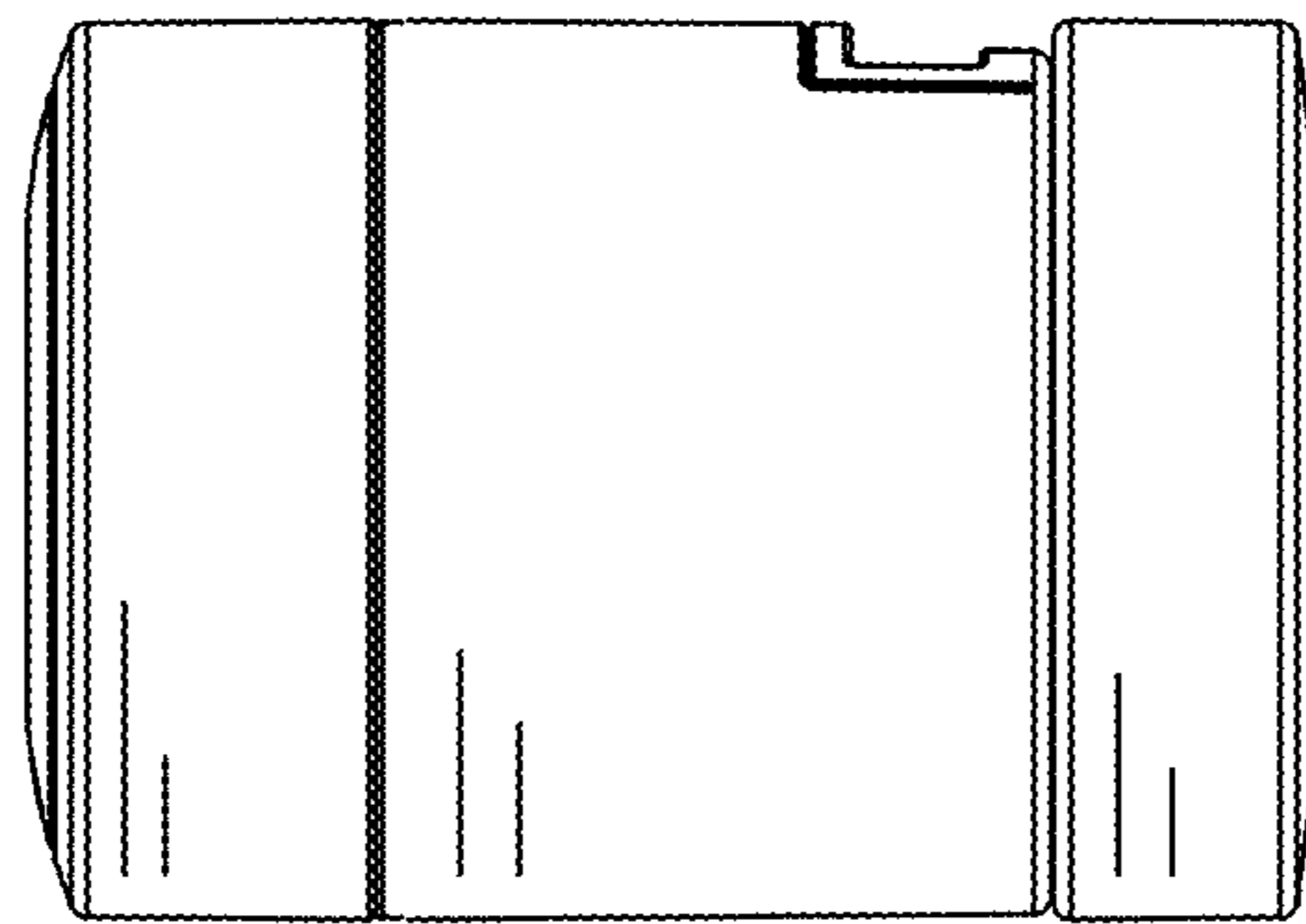

FIG. 4

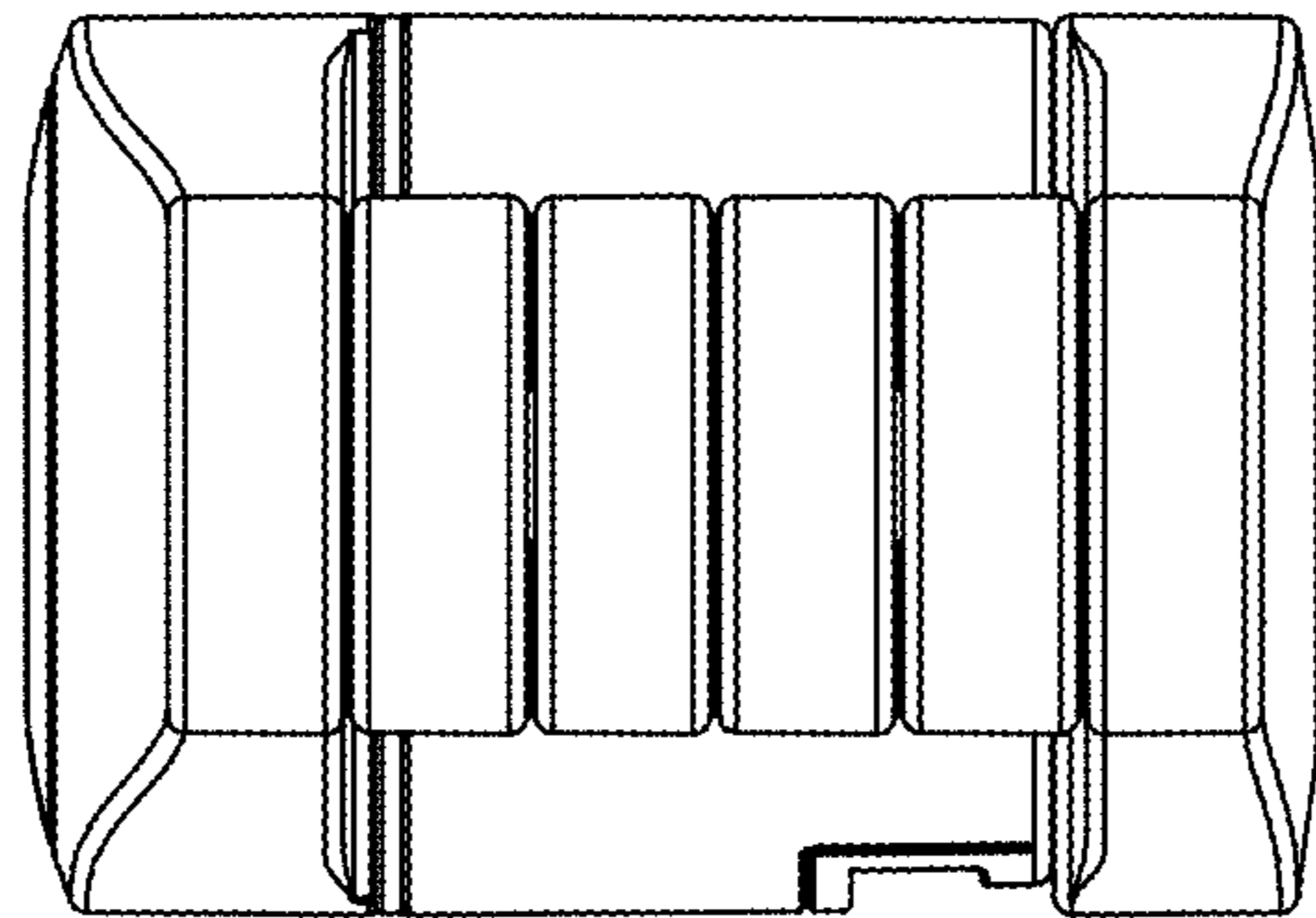

FIG. 5

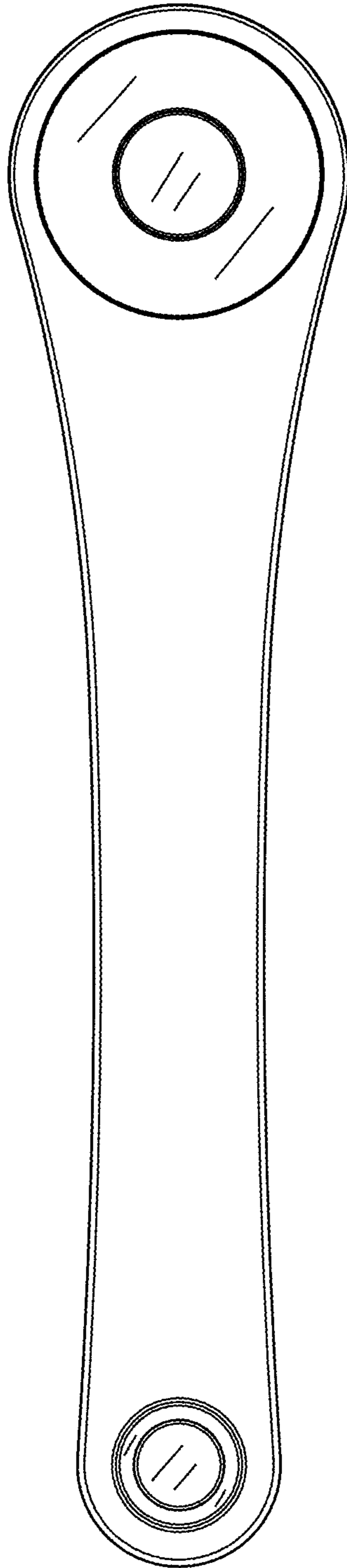

FIG. 6

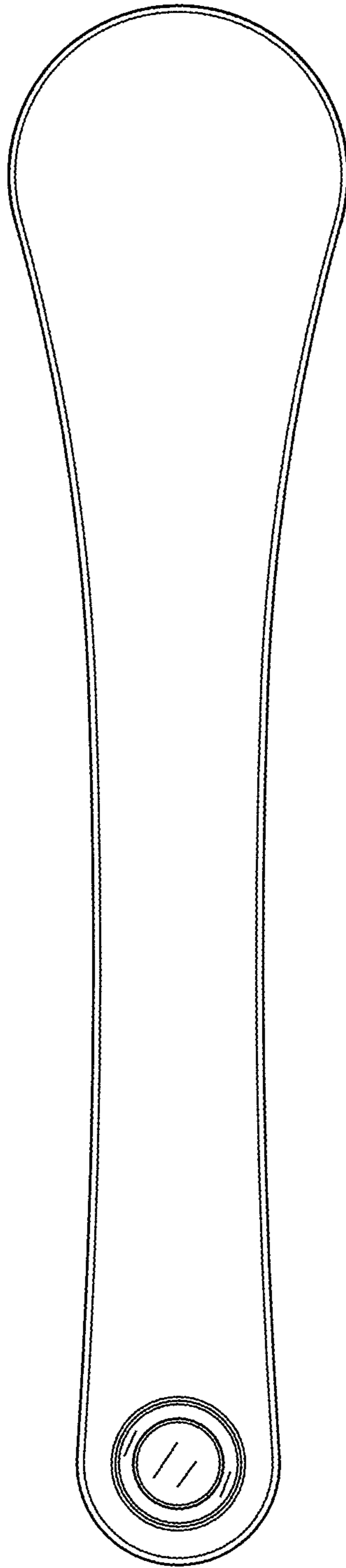

FIG. 7