



US00D793175S

(12) **United States Design Patent**  
**Kim et al.**

(10) **Patent No.:** **US D793,175 S**

(45) **Date of Patent:** **\*\* Aug. 1, 2017**

(54) **BODY FOR A JUICE EXTRACTOR**

(71) Applicant: **NUC Electronics Co., Ltd.**, Daegu (KR)

(72) Inventors: **Jong Boo Kim**, Daegu (KR); **Gun Wook Jo**, Daegu (KR)

(73) Assignee: **NUC ELECTRONICS CO., LTD.**, Daegu (KR)

(\*\*) Term: **15 Years**

(21) Appl. No.: **29/549,689**

(22) Filed: **Dec. 28, 2015**

(30) **Foreign Application Priority Data**

Jun. 26, 2015 (KR) ..... 30-2015-0032464

(51) **LOC (10) Cl.** ..... **07-04**

(52) **U.S. Cl.**  
USPC ..... **D7/665**

(58) **Field of Classification Search**  
USPC ..... D7/665-668, 372, 376, 381, 382, 386, D7/412  
CPC ..... A47J 19/02; A47J 19/027; A47J 19/00; A47J 19/06; A47J 19/022; A47J 43/046; A47J 43/0794; A23N 1/00; A23N 1/02; A23N 1/003

See application file for complete search history.

(56) **References Cited**

U.S. PATENT DOCUMENTS

D665,633 S \* 8/2012 Kim ..... D7/665  
D699,515 S \* 2/2014 Kim ..... D7/412  
D742,683 S \* 11/2015 Kim ..... D7/376  
D769,082 S \* 10/2016 Kim ..... D7/386

\* cited by examiner

*Primary Examiner* — Susan Bennett Hattan

*Assistant Examiner* — S. Bryan Reinholdt, Jr.

(74) *Attorney, Agent, or Firm* — Seed Intellectual Property Law Group LLP

(57) **CLAIM**

The ornamental design for a body for a juice extractor, as shown and described.

**DESCRIPTION**

FIG. 1 is an isometric view of a body for juice a extractor showing our new design;

FIG. 2 is a front elevational view thereof;

FIG. 3 is a rear elevational view thereof;

FIG. 4 is a left side elevational view thereof;

FIG. 5 is a right side elevational view thereof;

FIG. 6 is a top plan view thereof; and,

FIG. 7 is a bottom plan view thereof.

The broken lines in the figures represent features of the article of manufacture that form no part of the claimed design.

**1 Claim, 7 Drawing Sheets**

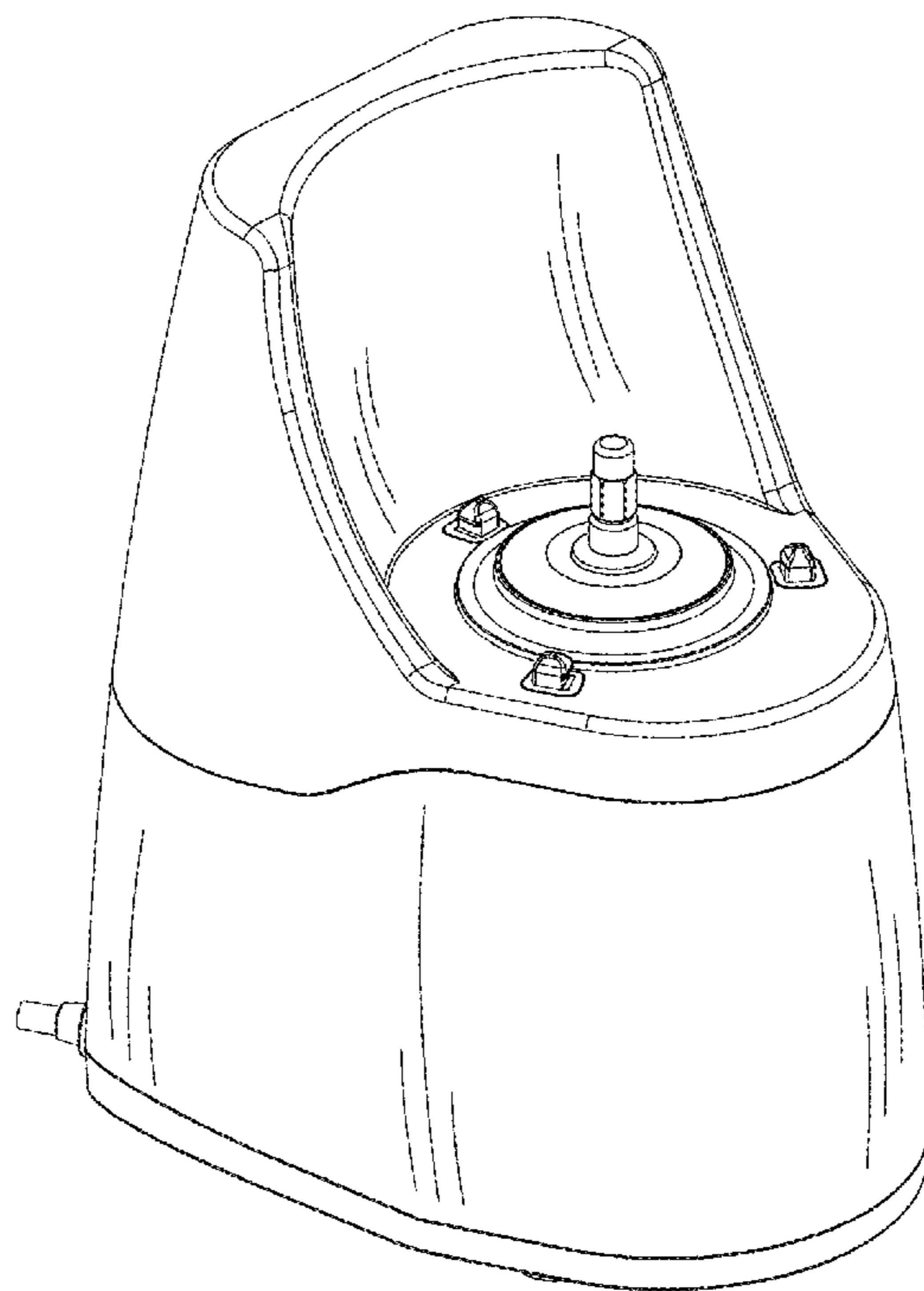

Fig. 1

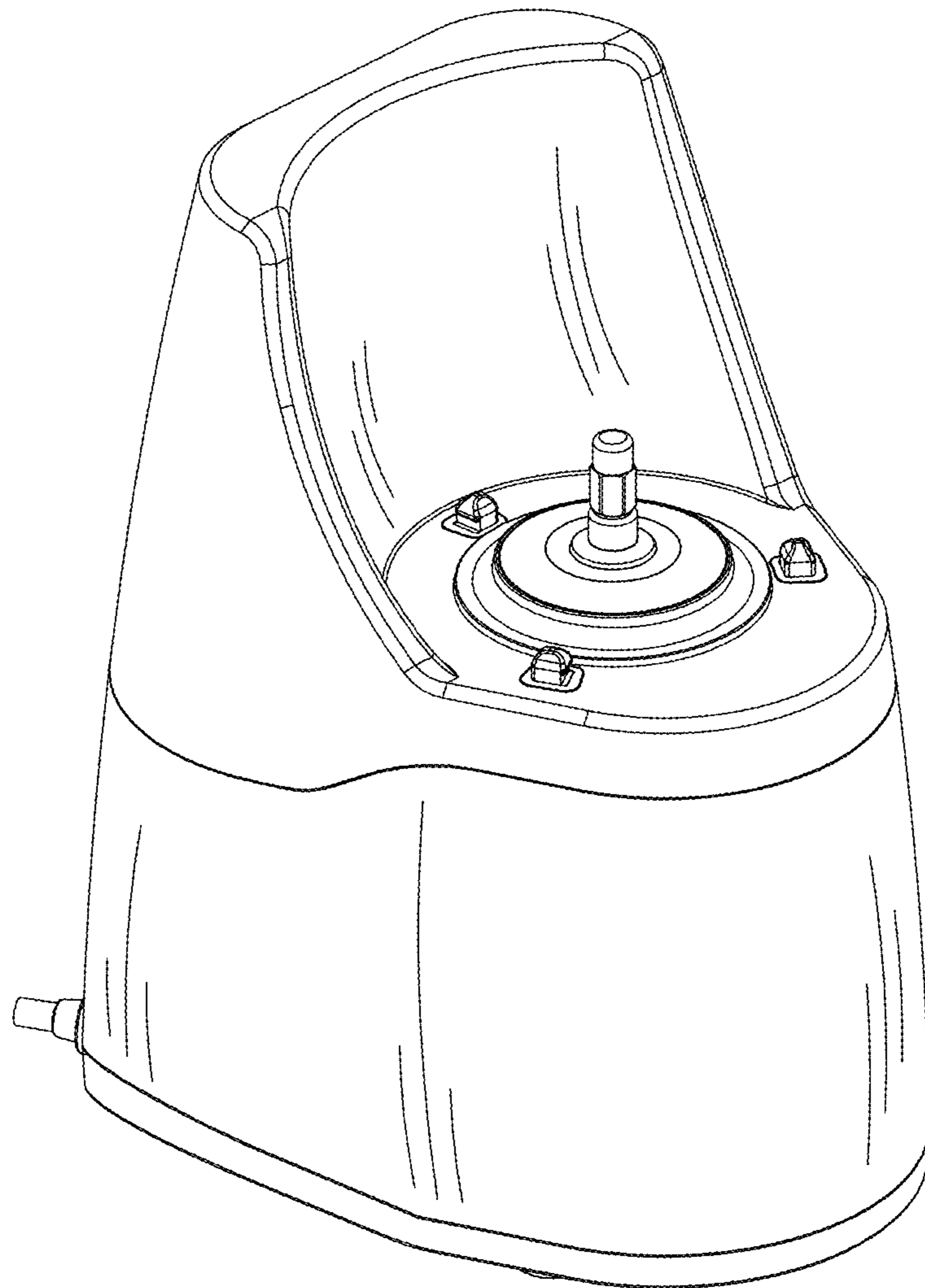
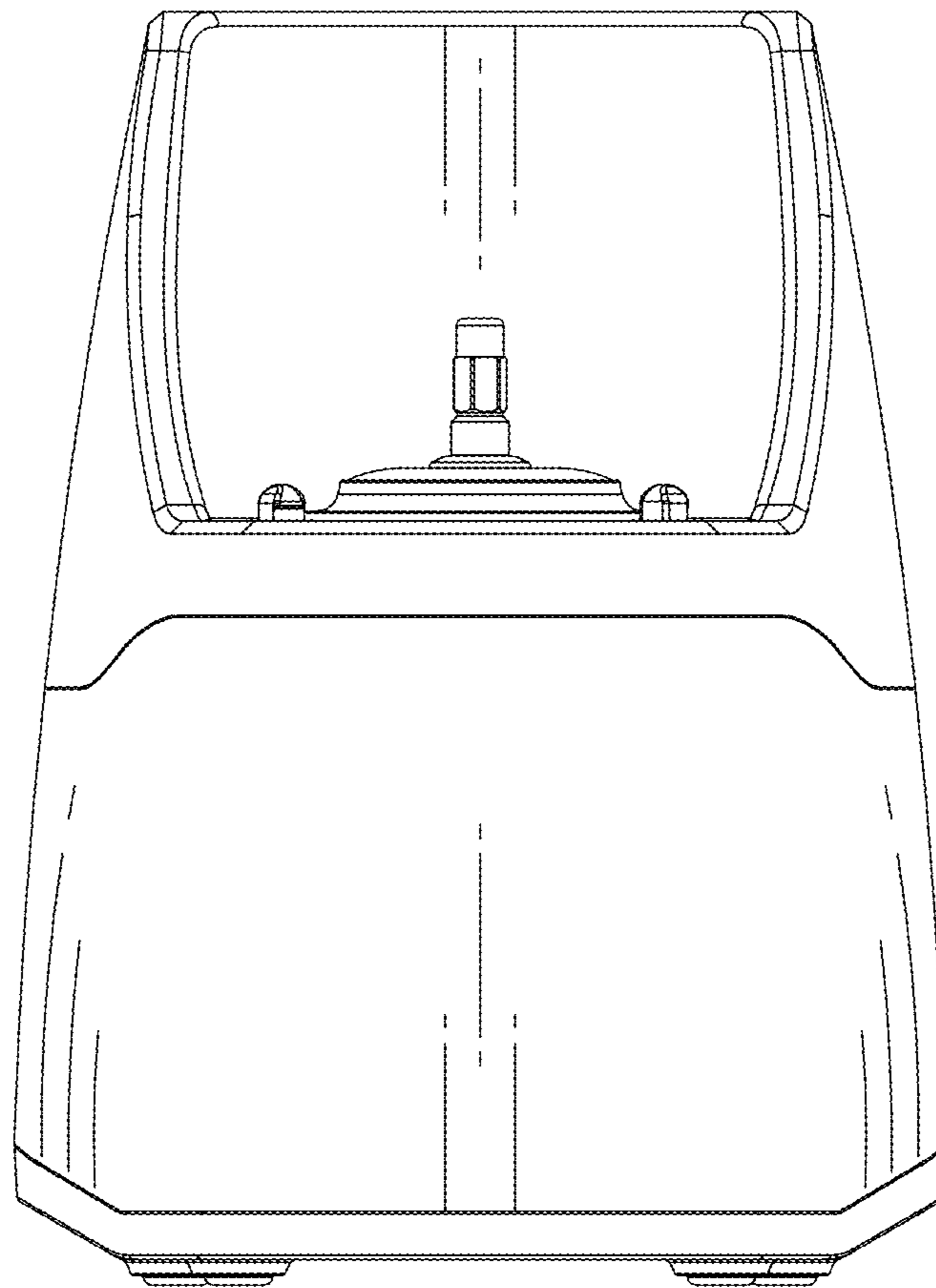

Fig. 2



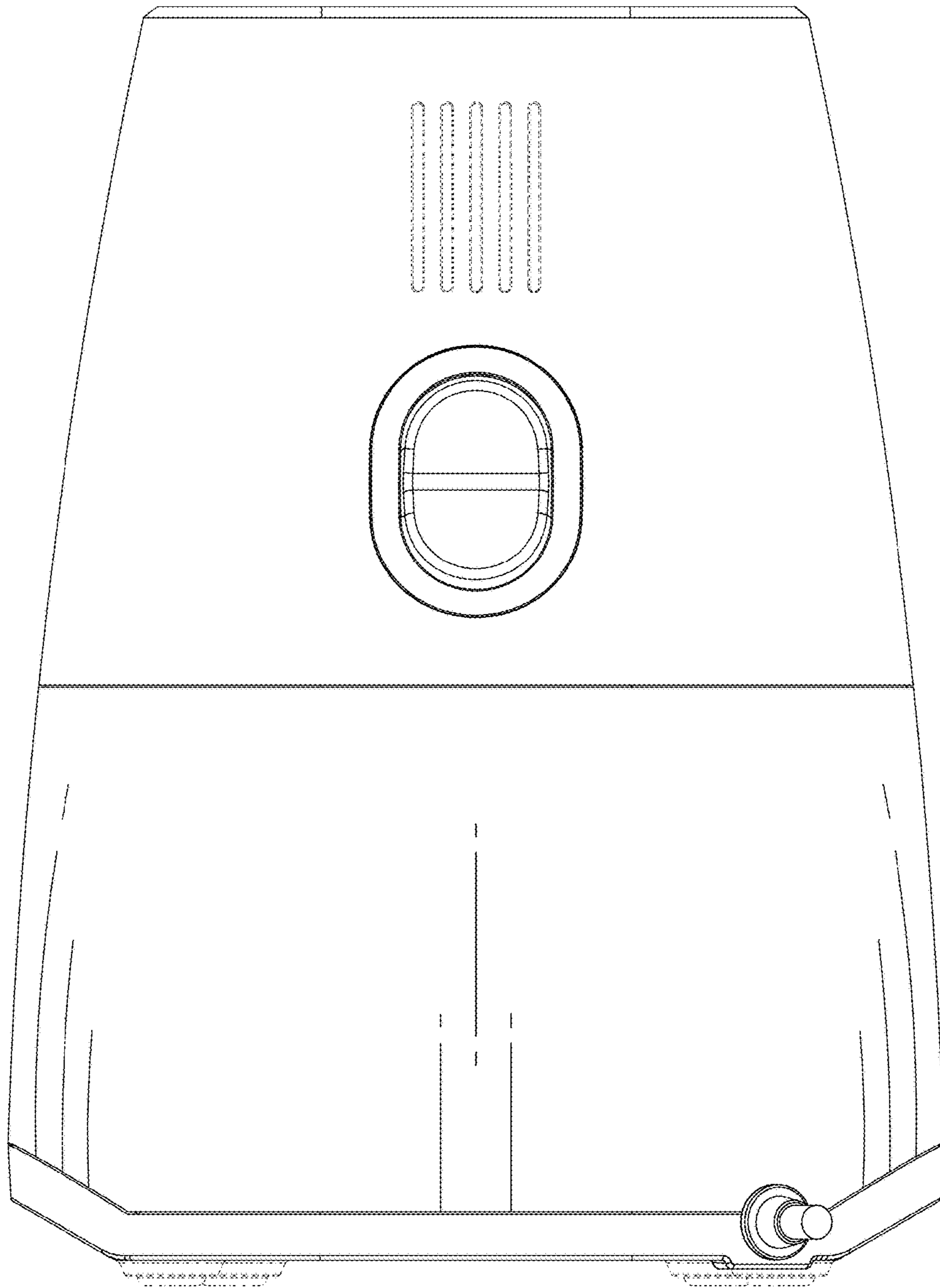

FIG. 3

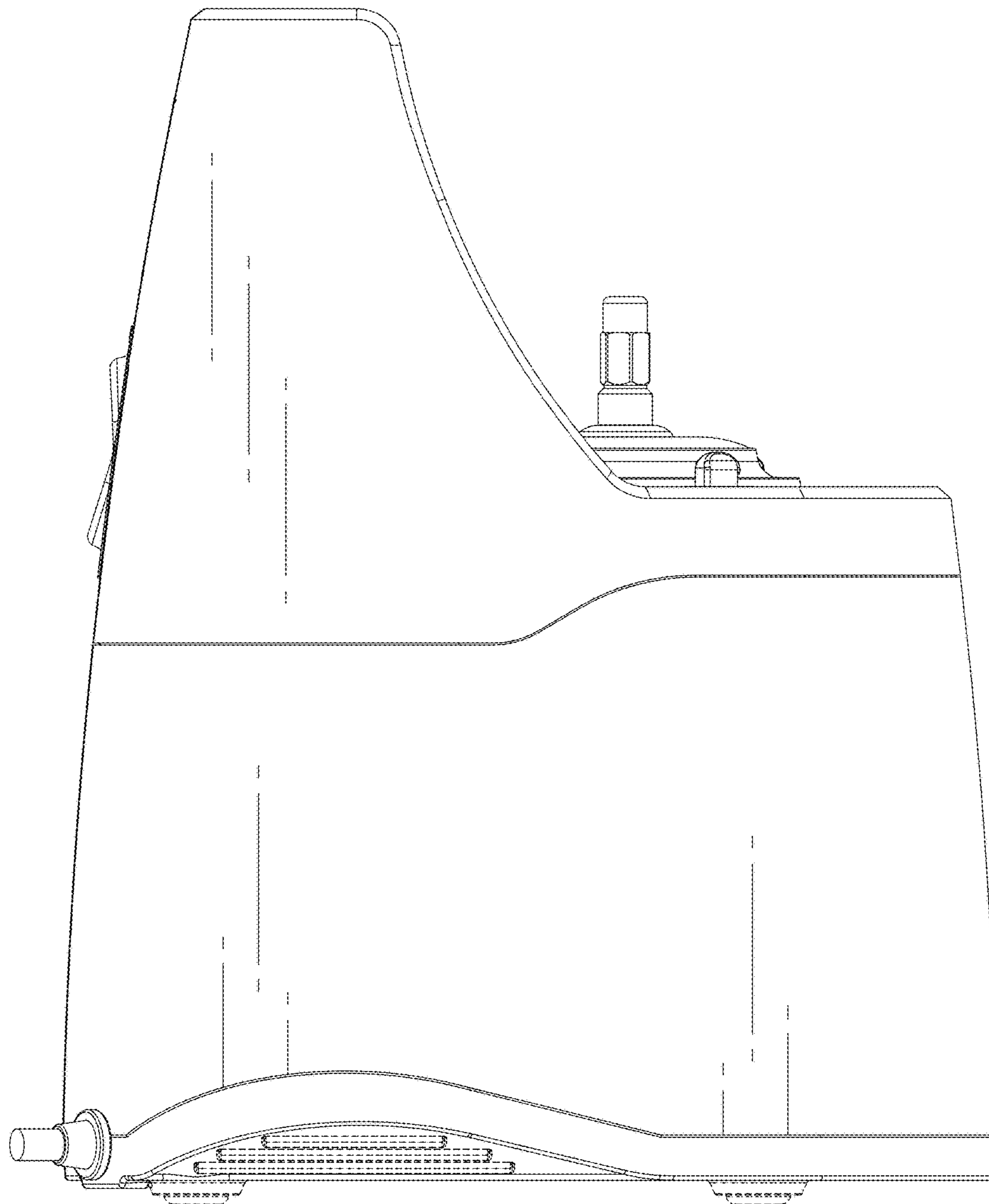

FIG. 4

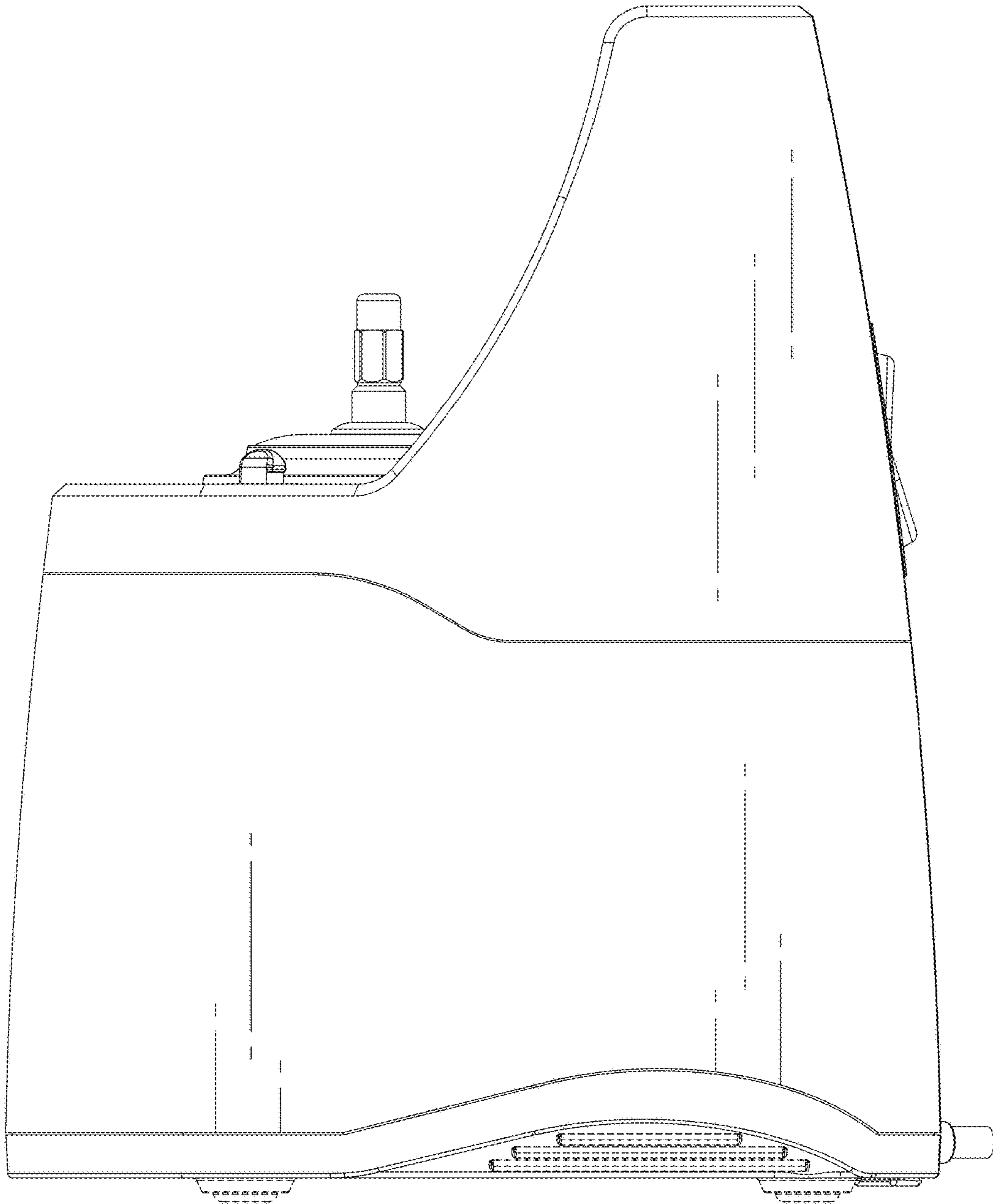

FIG. 5

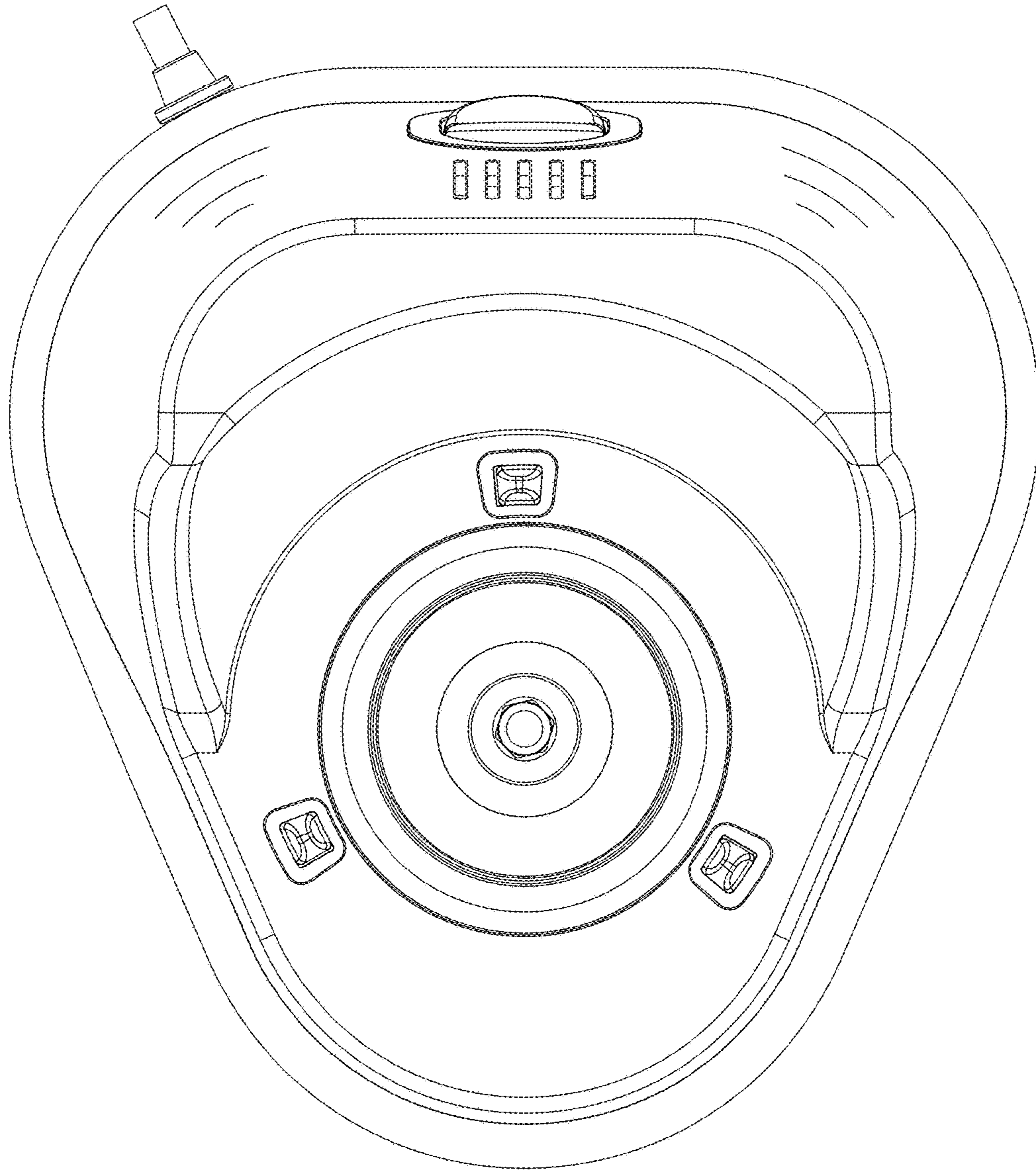

FIG. 6

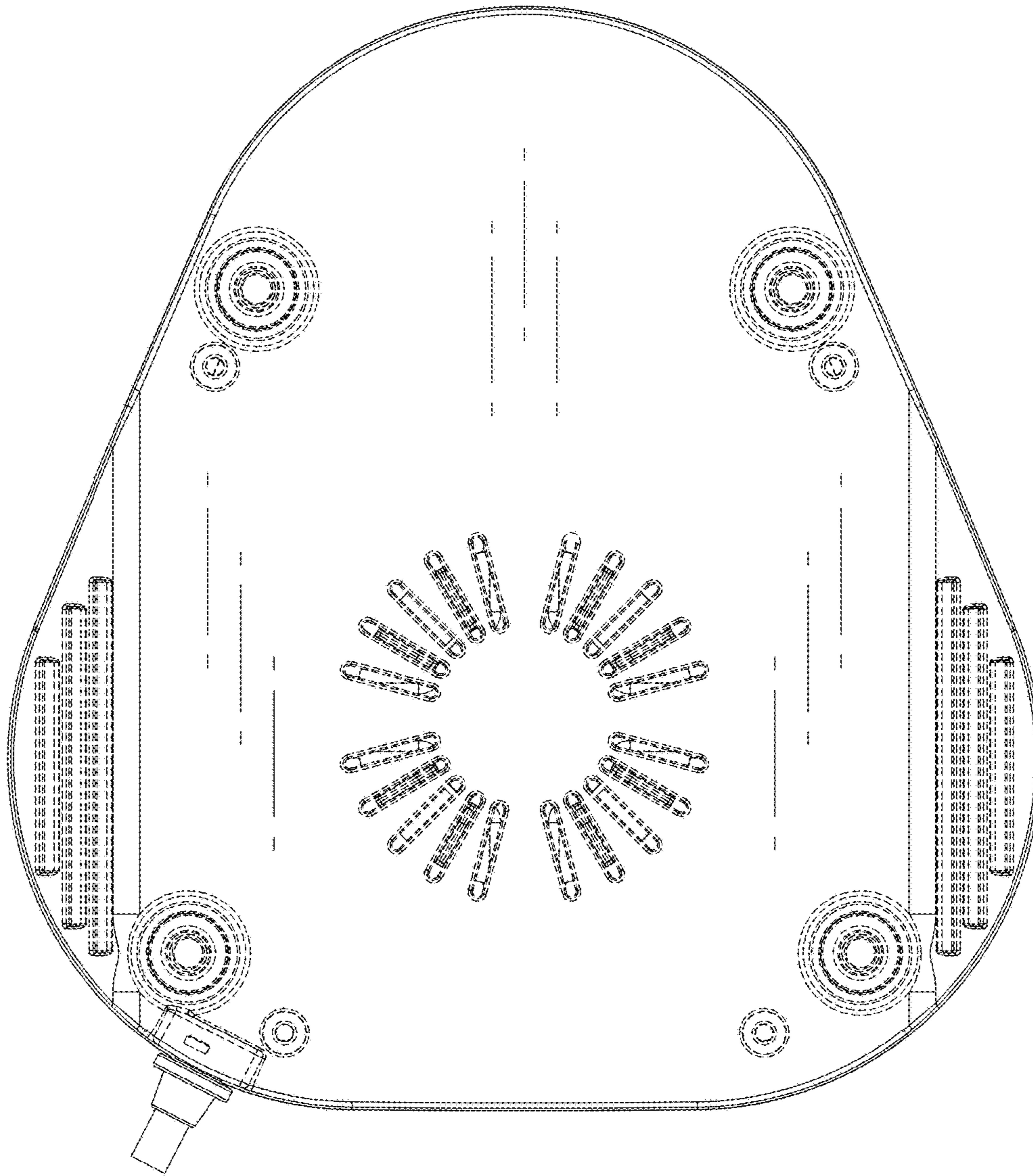

FIG. 7