



US00D793161S

(12) **United States Design Patent** (10) **Patent No.:** **US D793,161 S**  
**Fullmer et al.** (45) **Date of Patent:** **\*\* Aug. 1, 2017**

(54) **GRILL LINER**

F24C 15/12; F24C 15/14; F24C 15/16;  
F24C 15/164; F24C 15/18

(71) Applicant: **Trinidad Benham Corporation**,  
Denver, CO (US)

See application file for complete search history.

(72) Inventors: **Scott D. Fullmer**, Lone Tree, CO (US);  
**John W. Adam**, Castle Pines, CO (US);  
**Donald W. Lawson**, St. Simons Island,  
GA (US); **Christopher M. Eckert**,  
Huntington, IN (US)

(56) **References Cited**

U.S. PATENT DOCUMENTS

3,199,438 A \* 8/1965 Myler ..... A47J 37/041  
248/175  
D241,777 S \* 10/1976 Aliman ..... D15/89  
D311,339 S \* 10/1990 Weed ..... D7/359  
5,447,097 A 9/1995 Rhee  
5,453,574 A \* 9/1995 Zuran ..... A47J 37/067  
126/25 R

(73) Assignee: **Trinidad Benham Corporation**,  
Denver, CO (US)

(Continued)

(\*\*) Term: **15 Years**

OTHER PUBLICATIONS

(21) Appl. No.: **29/554,452**

“Grillpro Aluminum Foil Grilling Tray” by Onward Manufacturing  
Company, Ontario, Canada; 2014; 2 pp.

(22) Filed: **Feb. 11, 2016**

(Continued)

(51) **LOC (10) Cl.** ..... **07-02**

*Primary Examiner* — Ricky Pham

(52) **U.S. Cl.**

(74) *Attorney, Agent, or Firm* — Marsh Fischmann &  
Breyfogle, LLP

USPC ..... **D7/409**; D7/354

(58) **Field of Classification Search**

(57) **CLAIM**

USPC ..... D3/323; D6/601; D7/323, 332,  
D7/335–337, 354–355, 359–367,  
D7/387–388, 402, 407–409, 698;  
D9/456; D11/155; D15/89; D23/365

The ornamental design for a grill liner, as shown and  
described.

CPC .... A21B 2/00; A21B 3/00; A21B 3/13; A21B  
3/15; A21B 5/00; A21B 5/02; A23N  
12/06; A23N 12/08; A23N 12/10; A47J  
37/00; A47J 37/04; A47J 37/041; A47J  
37/042; A47J 37/06; A47J 37/067; A47J  
37/0688; A47J 37/0694; A47J 37/07;  
A47J 37/0704; A47J 37/10; A47J 47/20;  
A47J 2037/00; A47J 2037/06; A47J  
2037/0611; A47J 2037/07; A47J  
2037/0786; A47J 2037/0795; F24C 15/10;

**DESCRIPTION**

FIG. 1 is a top perspective view of a grill liner;  
FIG. 2 is a bottom perspective view of the grill liner of FIG.  
1;  
FIG. 3 is a top view of the grill liner of FIG. 1;  
FIG. 4 is a bottom view of the grill liner of FIG. 1;  
FIG. 5 is a front view of the grill liner of FIG. 1, the rear side  
being a mirror image thereof;  
FIG. 6 is a right side view of the grill liner of FIG. 1, the left  
side being a mirror image thereof;  
FIG. 7 is a cross-sectional view of the grill liner of FIG. 1,  
taken along line 7-7 of FIG. 3; and,

(Continued)

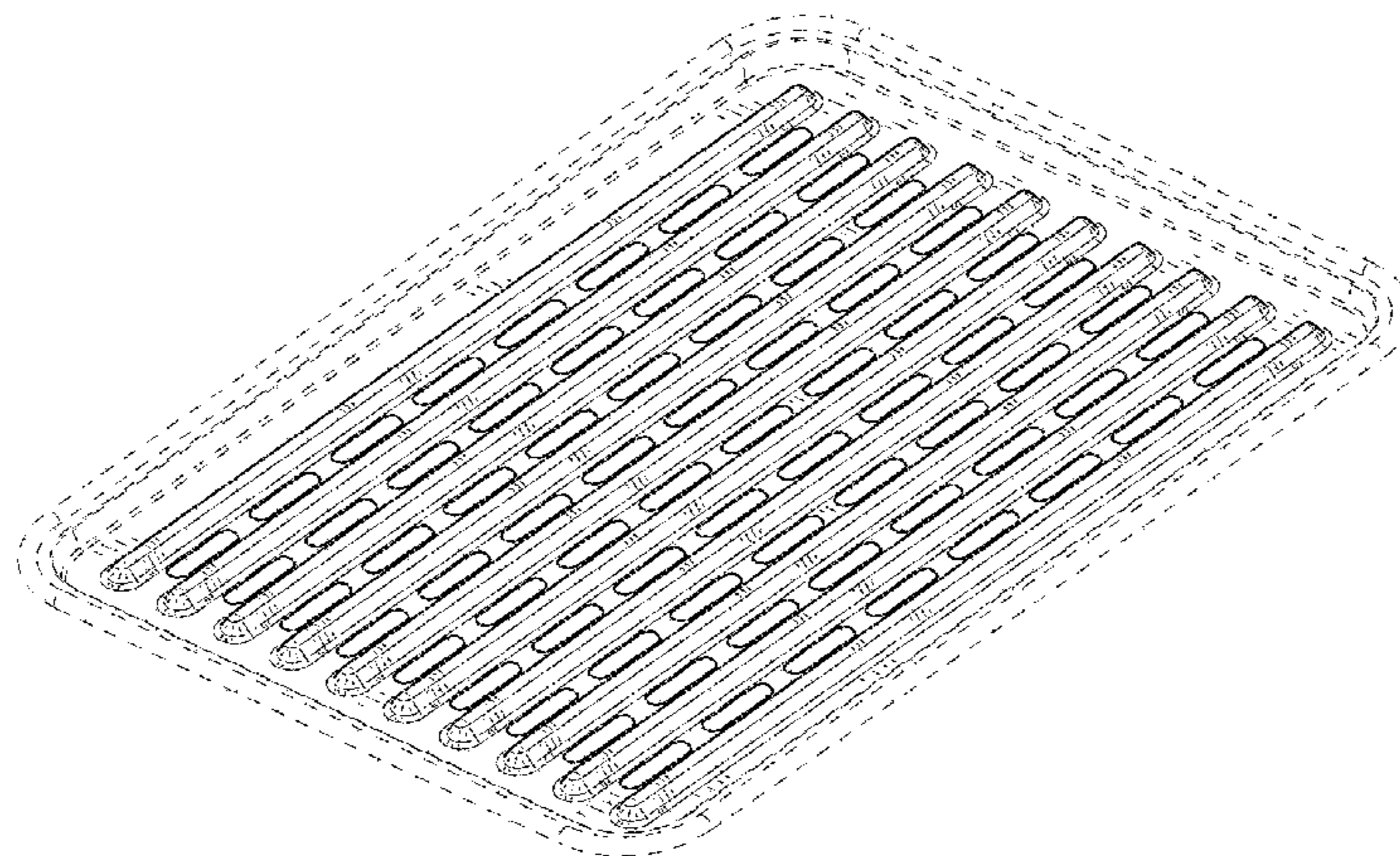

FIG. 8 is a cross-sectional view of the grill liner of FIG. 1, taken along line 8-8 of FIG. 3.

The broken lines in the drawing indicate environmental structure and form no part of the design to be patented.

**1 Claim, 6 Drawing Sheets**

(56)

**References Cited**

U.S. PATENT DOCUMENTS

5,884,555 A \* 3/1999 Chang ..... A47J 37/067  
99/400  
6,131,505 A \* 10/2000 Lin ..... A47J 37/041  
403/386  
D444,950 S \* 7/2001 Hwang ..... D3/323  
D463,202 S \* 9/2002 Smith ..... D7/359  
6,481,343 B1 \* 11/2002 Rigney ..... A47J 37/067  
99/396  
D566,556 S \* 4/2008 Baker ..... D9/456  
D567,022 S \* 4/2008 Spangrud ..... D7/409  
D569,160 S \* 5/2008 Mossbeck ..... D6/601  
D570,154 S \* 6/2008 Wang ..... D7/359

D600,070 S \* 9/2009 Kellermann ..... D7/409  
D604,556 S \* 11/2009 Zemel ..... D7/359  
D608,146 S \* 1/2010 Zemel ..... D7/409  
D618,047 S \* 6/2010 Seymour ..... D7/367  
7,810,487 B2 \* 10/2010 Johnston ..... A47J 37/0694  
126/152 A  
7,971,522 B2 7/2011 Sarnoff  
8,037,879 B2 \* 10/2011 Murrin ..... A47J 37/0694  
126/25 R  
D651,043 S \* 12/2011 Sarnoff ..... D7/354  
D655,130 S 3/2012 Sarnoff et al.  
D655,804 S \* 3/2012 Platt ..... D23/365  
8,234,973 B1 8/2012 Rhee  
D697,757 S \* 1/2014 Xin ..... D7/409  
D706,577 S \* 6/2014 Funnell, II ..... D7/354  
D727,791 S \* 4/2015 Montagano ..... D11/155  
D757,493 S \* 5/2016 Lee ..... D7/352  
D774,367 S \* 12/2016 Neal ..... D7/698

OTHER PUBLICATIONS

“BBQ King Grill Pan” by Handi-Foil of America; (date unknown);  
2 pp.  
Design U.S. Appl. No. 29/554,449, filed Feb. 11, 2016; 12 pp.

\* cited by examiner

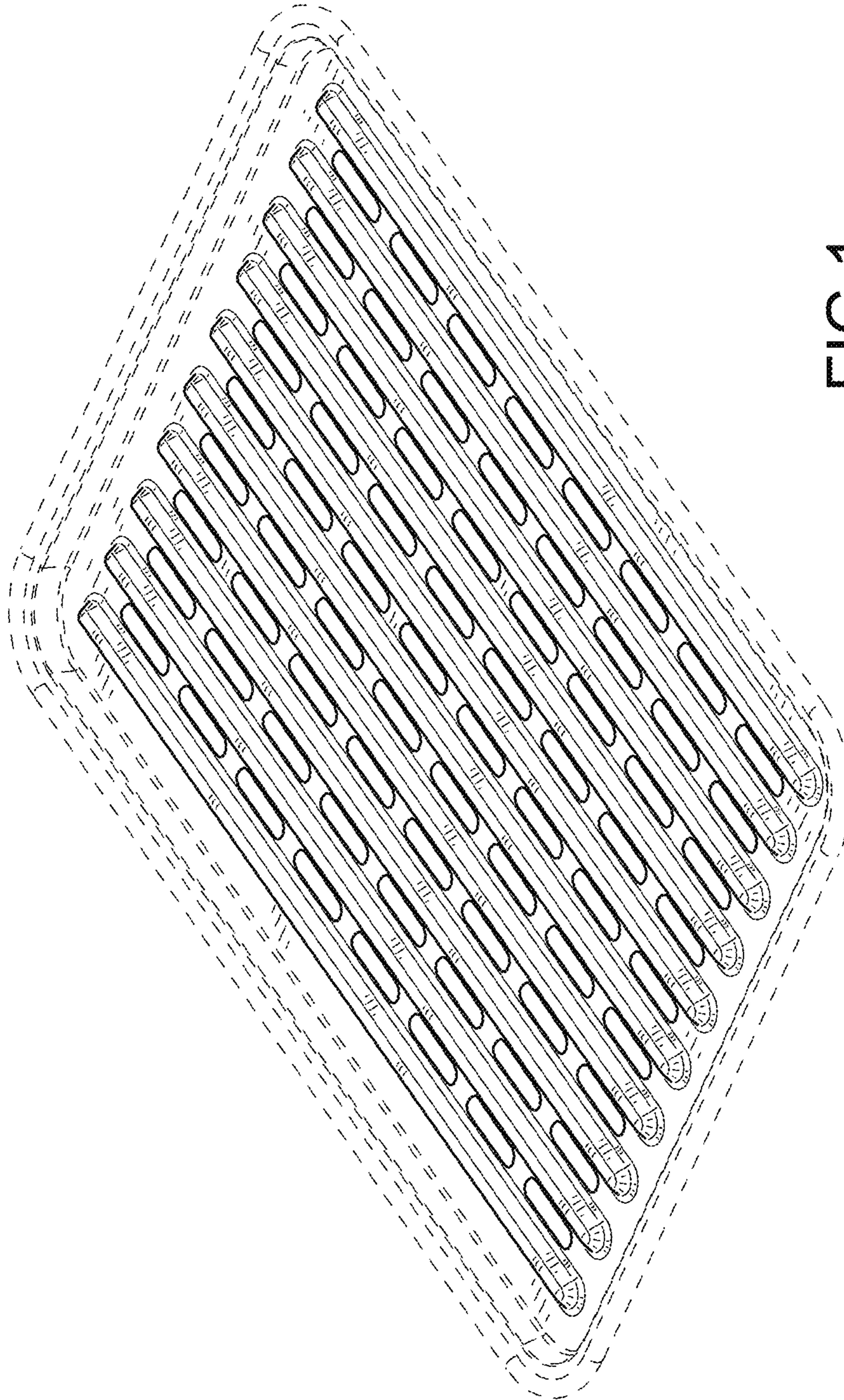

FIG.1

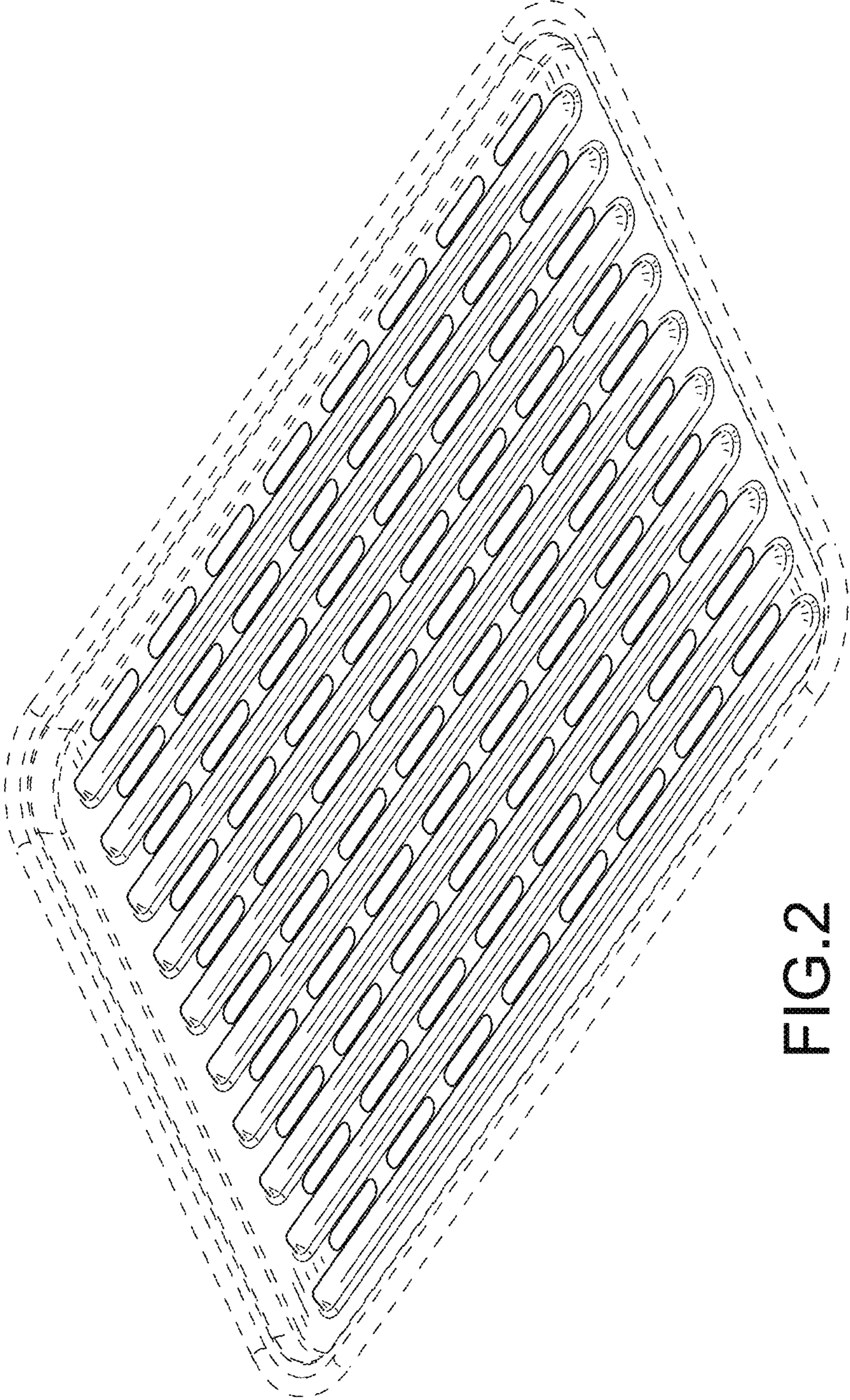

FIG.2

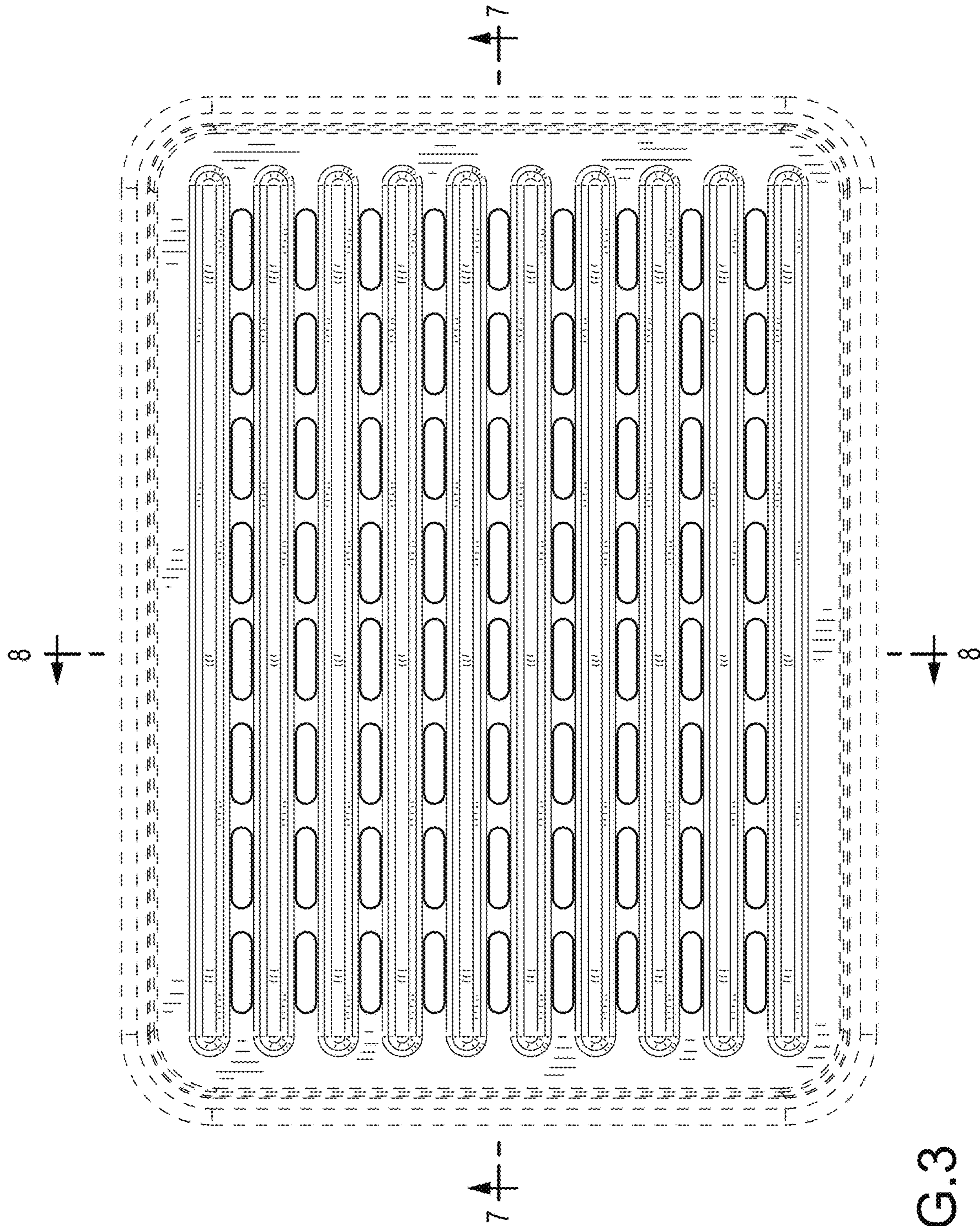

FIG. 3

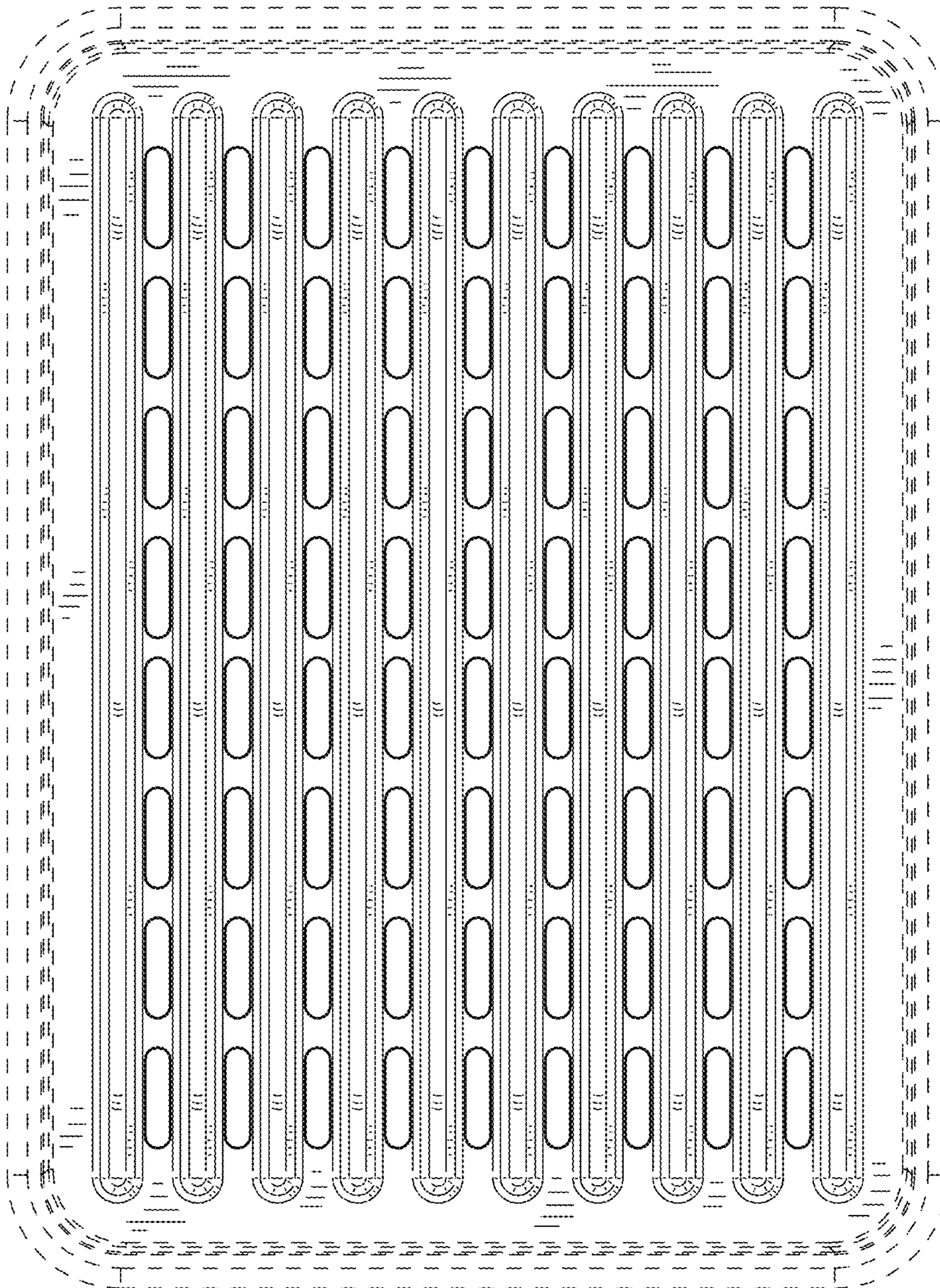

FIG.4

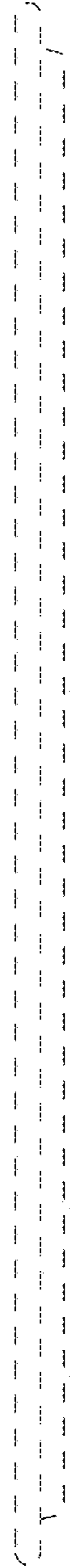

FIG. 5

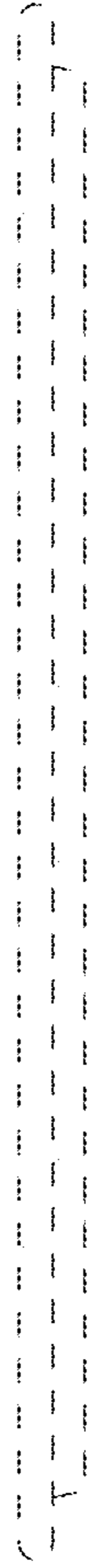

FIG. 6

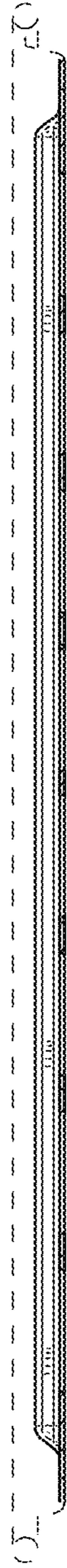

FIG. 7



FIG. 8