



US00D793109S

(12) **United States Design Patent**
Kaczmarek

(10) **Patent No.:** **US D793,109 S**

(45) **Date of Patent:** **** Aug. 1, 2017**

(54) **MULTI-USE CHAIR**

(71) Applicant: **Robert Kaczmarek**, Pittsburgh, PA
(US)

(72) Inventor: **Robert Kaczmarek**, Pittsburgh, PA
(US)

(**) Term: **15 Years**

(21) Appl. No.: **29/548,611**

(22) Filed: **Dec. 15, 2015**

(51) **LOC (10) Cl.** **06-01**

(52) **U.S. Cl.**
USPC **D6/361**

(58) **Field of Classification Search**
USPC D6/334-336, 361, 371, 373, 374, 375,
D6/716, 716.1, 716.4
CPC A47C 1/143; A47C 7/50; A47C 5/125;
A47C 5/00; A47C 20/021
See application file for complete search history.

(56) **References Cited**

U.S. PATENT DOCUMENTS

D90,878 S * 10/1933 Goodman D6/361
D153,932 S * 5/1949 Fraser D6/361
D175,624 S * 9/1955 Laskowitz D6/361
D183,790 S * 10/1958 Deaton 297/423.1

D227,204 S * 6/1973 Grierson D6/361
D228,428 S * 9/1973 Wilson D6/361
4,066,293 A * 1/1978 Meier A47C 1/143
297/325
D300,390 S * 3/1989 Soley D6/361
D406,473 S * 3/1999 Lin D6/361
D490,618 S * 6/2004 Green D6/361
D530,933 S * 10/2006 Vitaro D6/361
D645,268 S * 9/2011 Robson D6/361
D648,551 S * 11/2011 Clark D6/361
D745,786 S * 12/2015 Ko D6/361
9,314,103 B1 * 4/2016 Lakkios A47C 7/50

* cited by examiner

Primary Examiner — Mimosa De

(57) **CLAIM**

The ornamental design for a multi-use chair, as shown and described.

DESCRIPTION

FIG. 1 is a front perspective view of a multi-use chair showing my new design;
FIG. 2 is a rear perspective view thereof;
FIG. 3 is a right side view thereof; the left side view being a mirror image;
FIG. 4 is a front view thereof;
FIG. 5 is a rear view thereof;
FIG. 6 is a top view thereof; and,
FIG. 7 is a bottom view thereof.

1 Claim, 7 Drawing Sheets

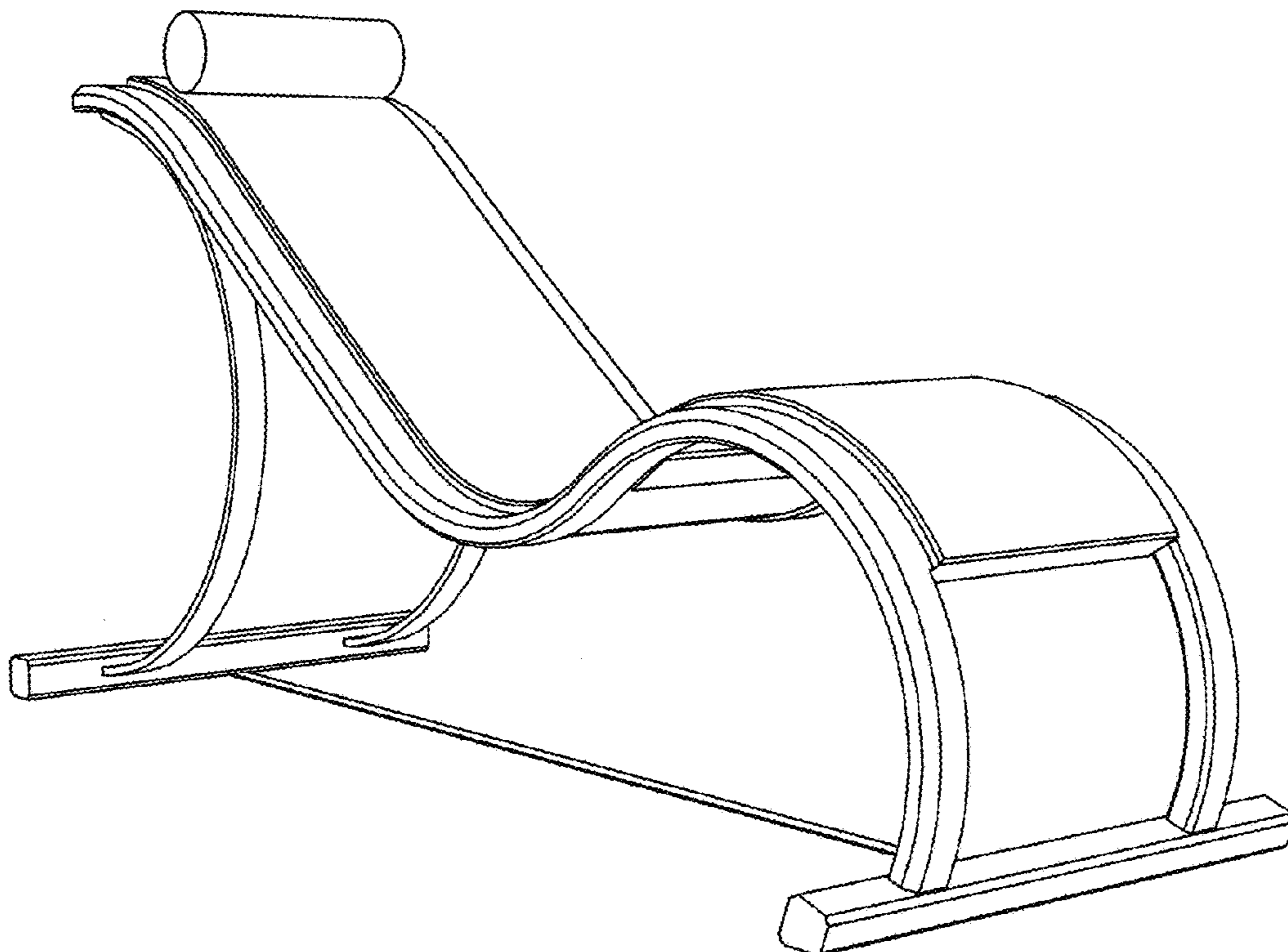

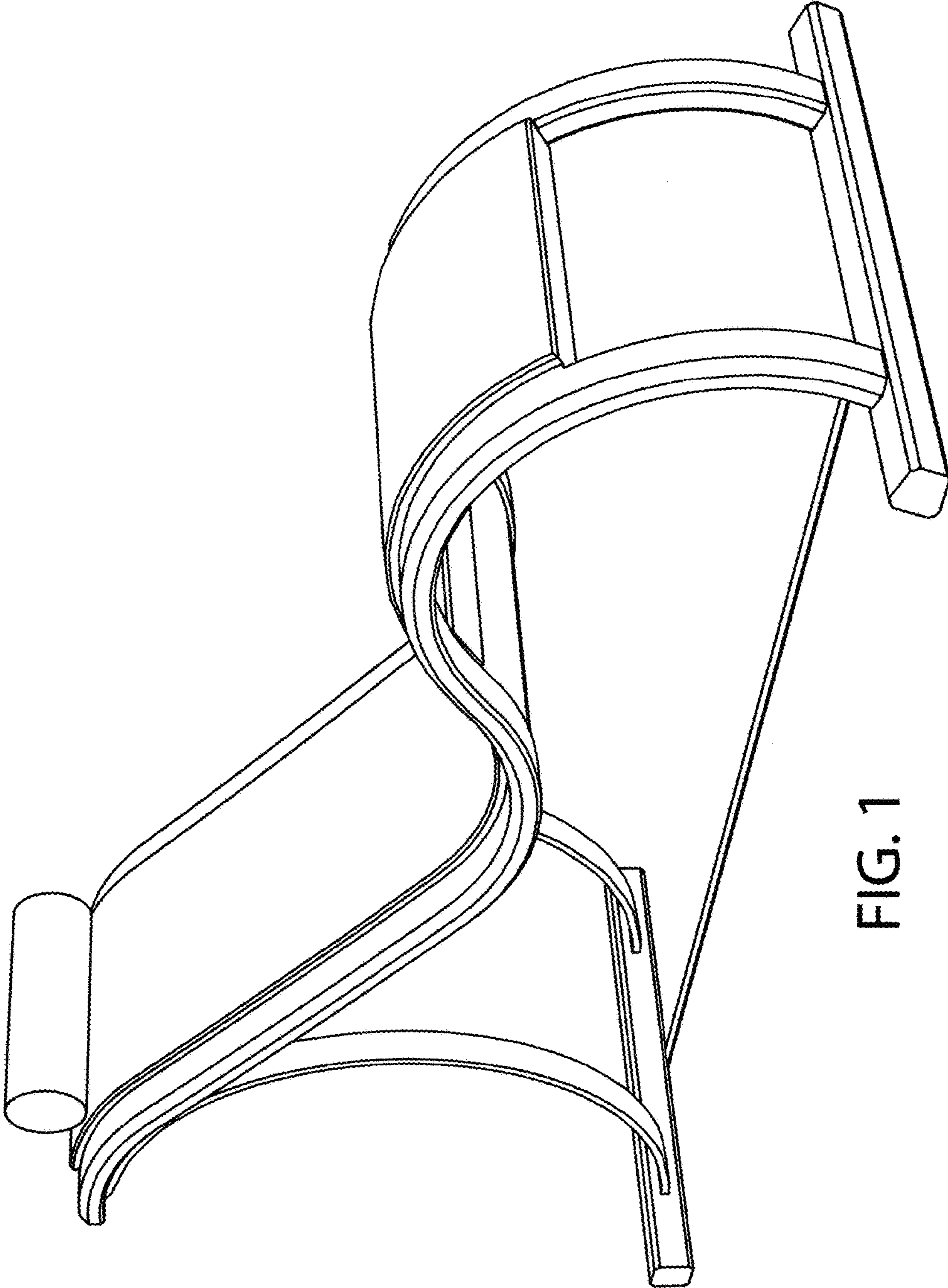

FIG. 1

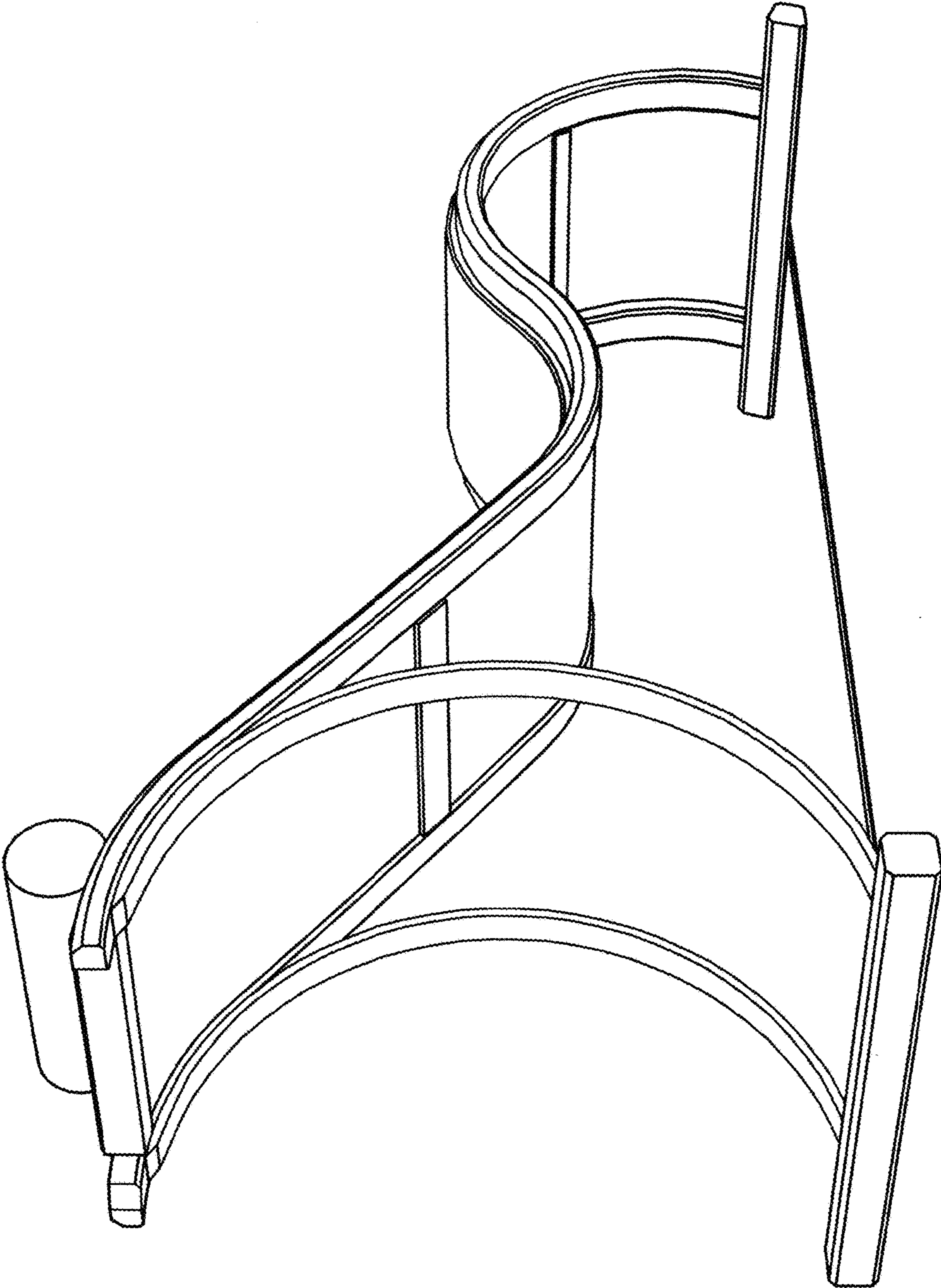

FIG. 2

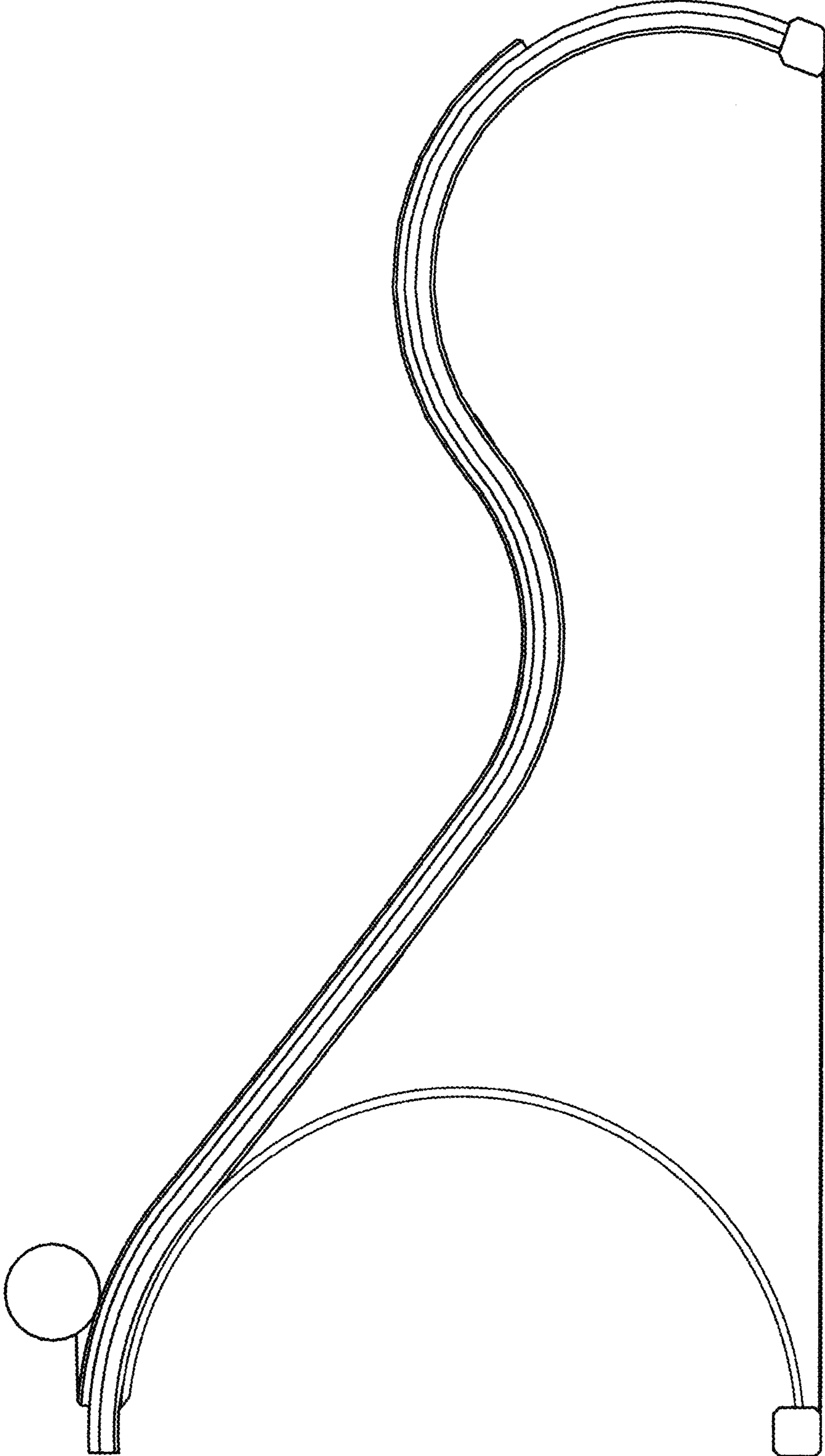

FIG. 3

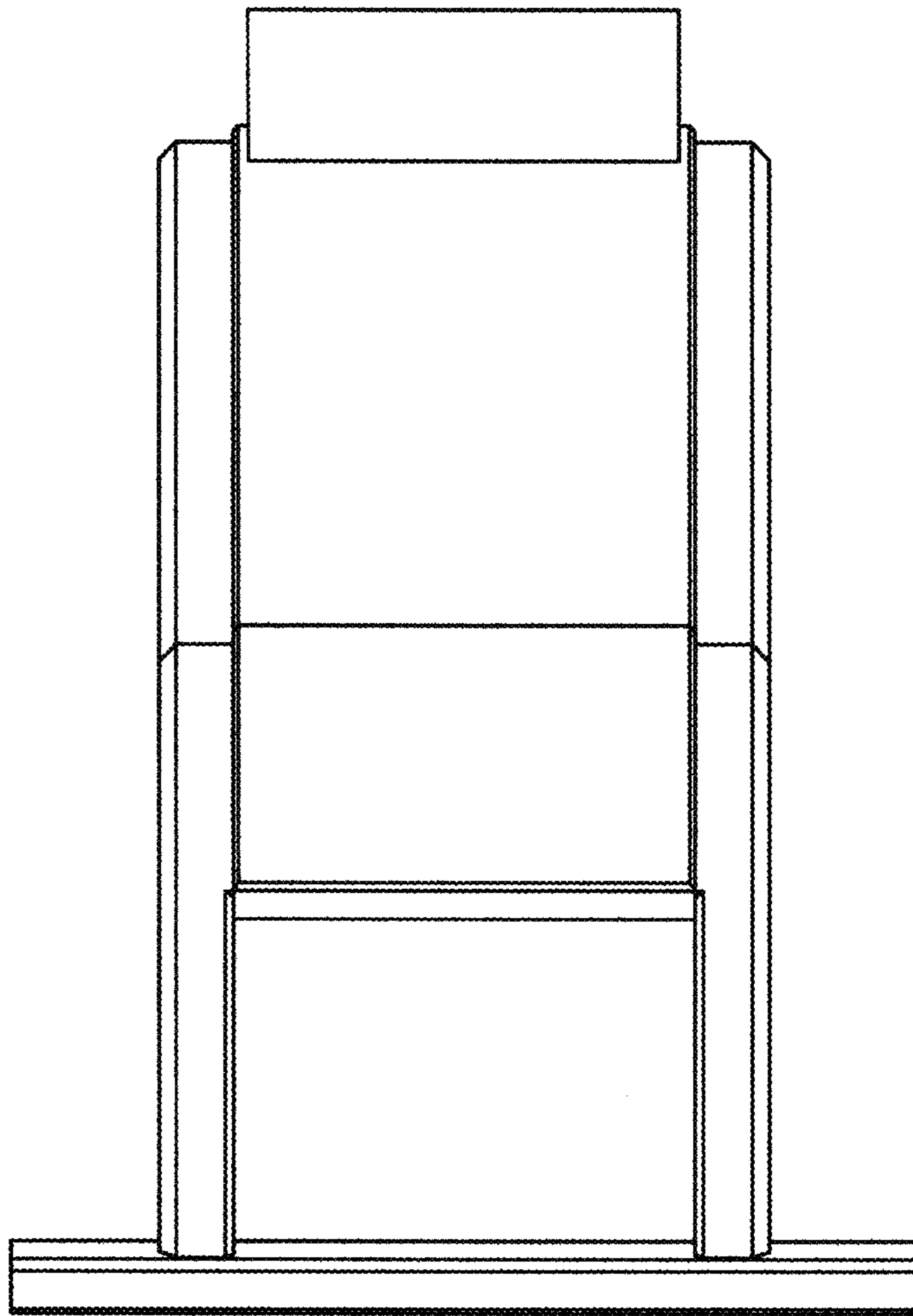

FIG. 4

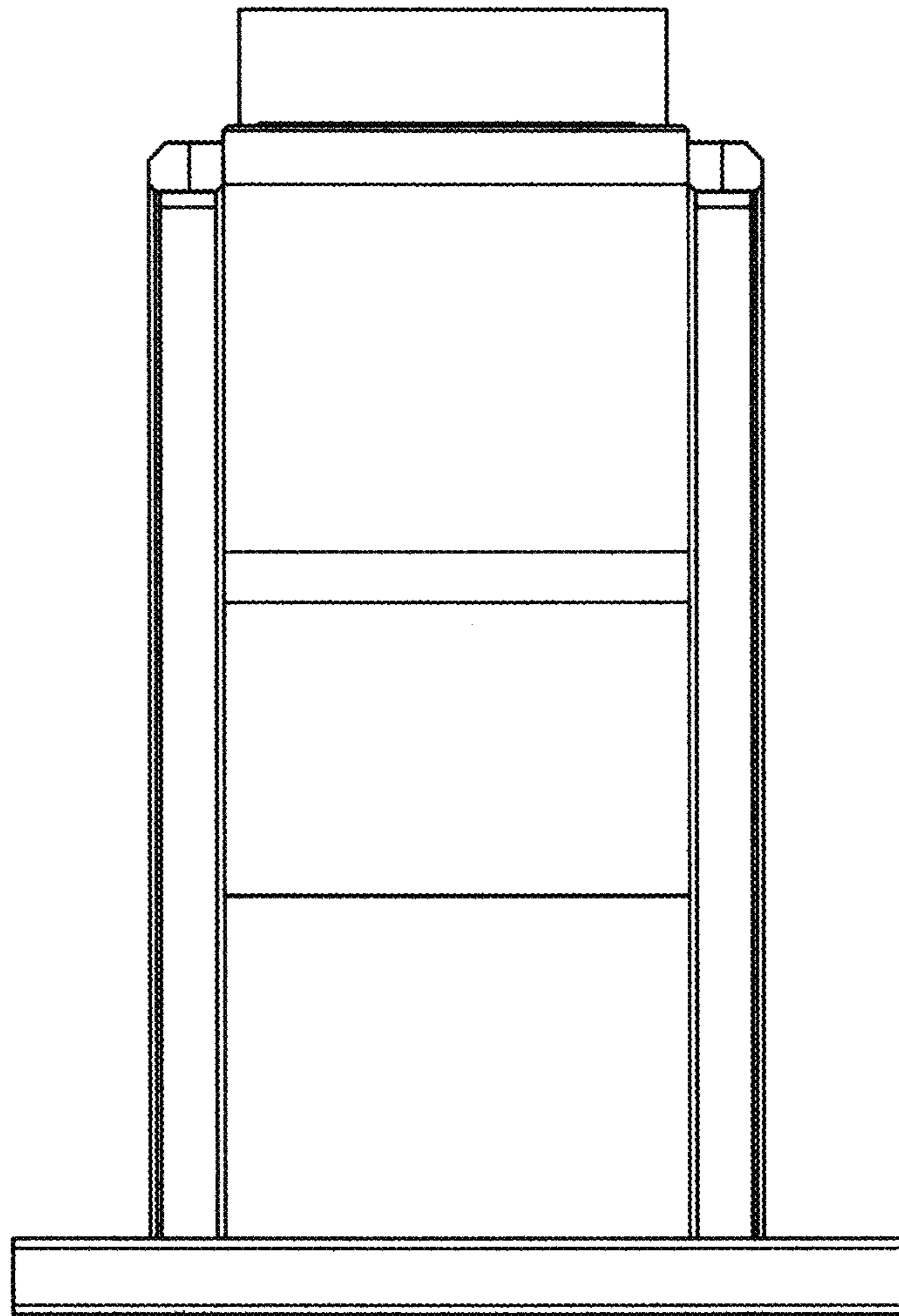

FIG. 5

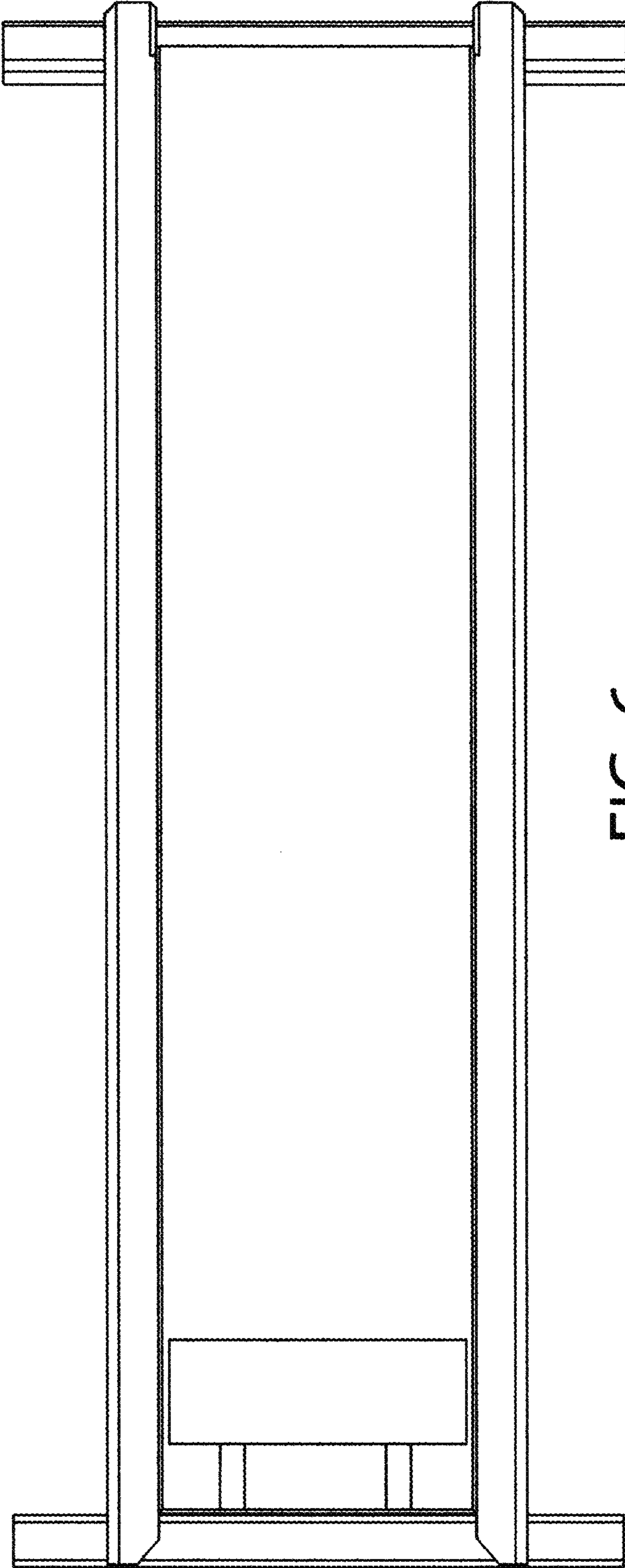

FIG. 6

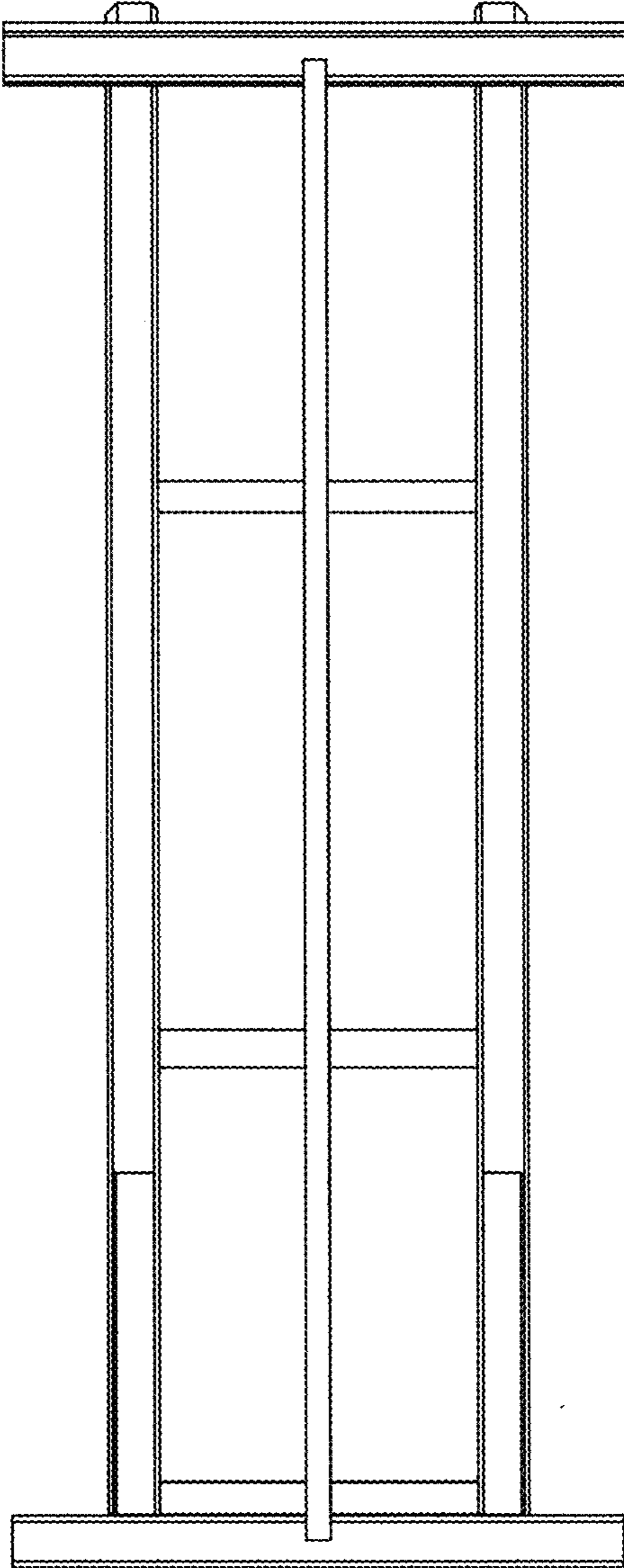

FIG. 7