



US00D793092S

(12) **United States Design Patent** (10) **Patent No.:** **US D793,092 S**
Morton et al. (45) **Date of Patent:** **** Aug. 1, 2017**

(54) **BRUSH HANDLE**

D191,876 S * 12/1961 Hvale D7/395
4,217,915 A 8/1980 Gress
D281,728 S 12/1985 Sherman
D294,743 S 3/1988 Seki

(71) Applicant: **Goody Products, Inc.**, Atlanta, GA (US)

(Continued)

(72) Inventors: **Timothy James Morton**, Kalamazoo, MI (US); **Roberta Celeste Brown**, Kalamazoo, MI (US); **Carl Johan Liden**, New York, NY (US); **Brett Tobias Tom**, San Francisco, CA (US); **Nicholas Burrows**, Brooklyn, NY (US); **Eric Call**, New York, NY (US)

FOREIGN PATENT DOCUMENTS

CA 169798 3/2017
CA 169799 * 3/2017

(Continued)

(73) Assignee: **Goody Products, Inc.**, Atlanta, GA (US)

OTHER PUBLICATIONS

US Trademark Application #86595257 (new Registered Trademark #5138142) for "Amp It Up," filed on Apr. 13, 2015 by Goody Products, Inc., First use in Commerce Date: Mar. 31, 2016. Publication Date: Sep. 8, 2015. Retrieved Feb. 10, 2017. 3 pages.*

(Continued)

(**) Term: **15 Years**

Primary Examiner — Karen E. Eldridge Powers

Assistant Examiner — Jasmine Mlinarcik

(21) Appl. No.: **29/553,840**

(74) *Attorney, Agent, or Firm* — Stephanie Chu

(22) Filed: **Feb. 4, 2016**

(51) **LOC (10) Cl.** **04-02**

(52) **U.S. Cl.**

USPC **D4/138; D4/134**

(58) **Field of Classification Search**

USPC D4/100, 127, 130, 132, 133, 134, 136;
D7/395; D28/21, 28, 30, 64.4, 64.7, 73;
D32/49; 15/106, 143.1, 159.1, 186, 187
CPC A45D 24/00; A45D 24/10; A45D 24/14;
A46B 9/00; A46B 9/023; A46B 15/0085;
A46B 15/0087; A46B 15/0095; A46B
2200/104; A46B 2200/205
See application file for complete search history.

(57) **CLAIM**

The ornamental design for a brush handle, as shown and described.

DESCRIPTION

FIG. 1 is a perspective view of a brush handle showing a new design;
FIG. 2 is a front elevation view thereof;
FIG. 3 is a back elevation view thereof;
FIG. 4 is a right side elevation view thereof;
FIG. 5 is a left side elevation view thereof;
FIG. 6 is a top plan view thereof; and,
FIG. 7 is a bottom plan view thereof.
The subject matter shown in dashed lines represents environmental structure and forms no part of the claimed design.

(56) **References Cited**

U.S. PATENT DOCUMENTS

D48,399 S * 1/1916 Scheuer D4/134
1,957,363 A * 5/1934 Snell A46B 3/16
15/186
1,963,360 A 6/1934 Gibbin
2,197,551 A 4/1940 Jensen

1 Claim, 5 Drawing Sheets

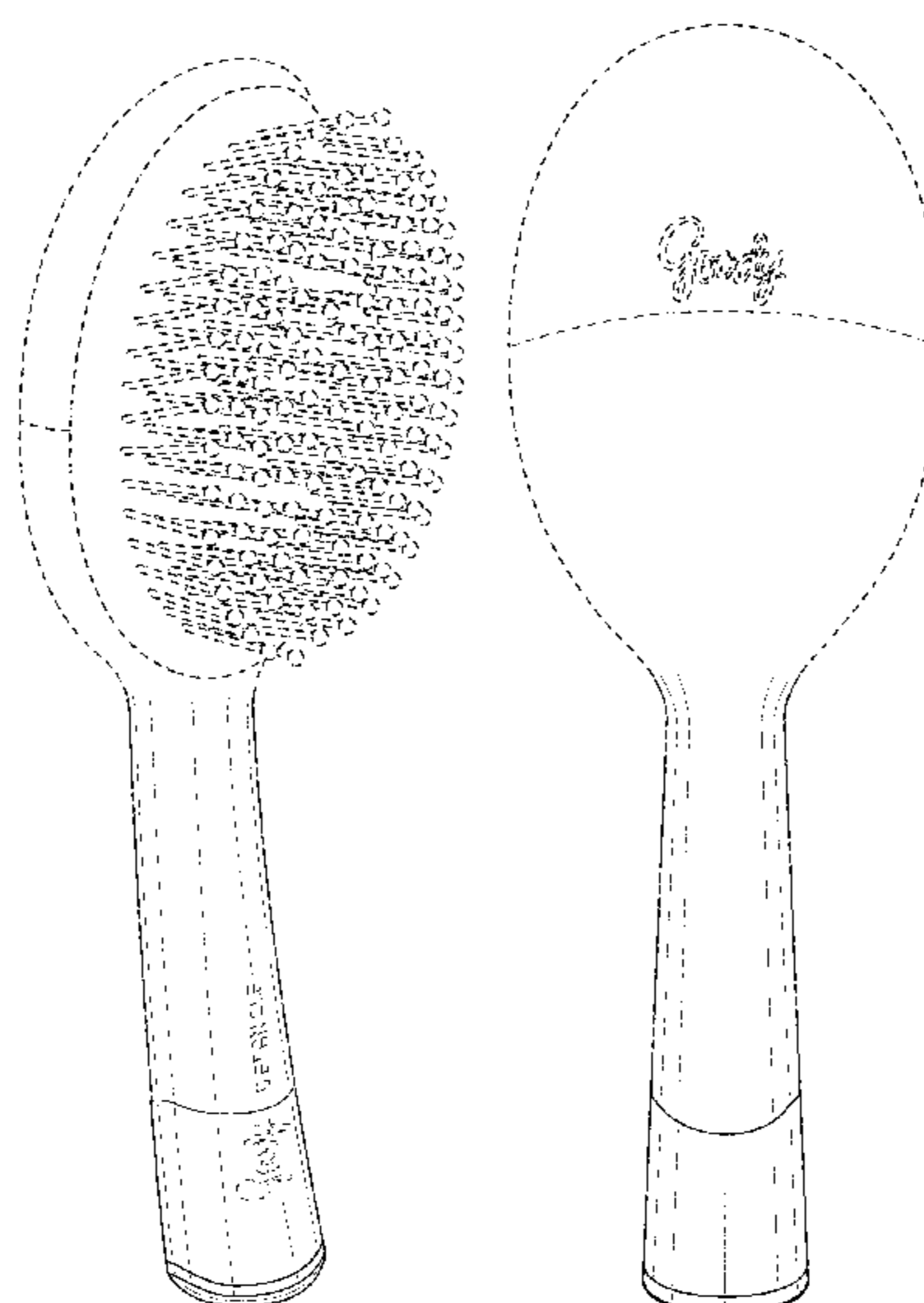

(56)

References Cited

U.S. PATENT DOCUMENTS

D299,279	S	1/1989	Reeves	
D339,210	S	9/1993	Classen	
D379,508	S	5/1997	Hudson	
D381,207	S	7/1997	Gertsma	
5,911,226	A	6/1999	Vecchiola	
5,979,463	A	11/1999	Santy, III	
D427,776	S	7/2000	Chan	
6,213,129	B1	4/2001	Muldoon	
D479,916	S	9/2003	Park	
6,658,687	B1 *	12/2003	McDonald A46B 15/0042 15/105
D510,192	S	10/2005	Kampel	
D513,883	S	1/2006	Kampel	
D539,547	S	4/2007	Leung	
D539,548	S	4/2007	Leung	
D541,534	S	5/2007	Leung	
D543,363	S	5/2007	Leung	
D543,705	S *	6/2007	Leung D4/133
D580,178	S *	11/2008	Bingaman D4/134
7,526,829	B2	5/2009	Chang	
7,690,733	B2	4/2010	Spitale	
D627,976	S	11/2010	Magallanes Orozco	
D646,062	S	10/2011	Leventhal	
D668,054	S	10/2012	Julemont	
8,573,231	B2	11/2013	Ragosta	
D696,026	S	12/2013	Park	
D708,857	S	7/2014	Brown	
D709,705	S	7/2014	Brown	
8,826,918	B2	9/2014	Hornbach	
D721,233	S	1/2015	Schuler	
D721,234	S	1/2015	Schuler	
D721,505	S	1/2015	Schuler	
D721,508	S	1/2015	Schuler	
D724,849	S *	3/2015	Schuler D4/133
D730,060	S	5/2015	Rennette	
9,402,460	B2 *	8/2016	Hickey A46B 9/023
D771,393	S	11/2016	Michelson	
D781,598	S	3/2017	Treeby	
D782,202	S *	3/2017	Machiorlette D4/127
2001/0001887	A1	5/2001	Bigio	
2006/0037879	A1	2/2006	Christmas	
2006/0288512	A1	12/2006	Kinchen	
2014/0101879	A1	4/2014	Brown	
2014/0366910	A1	12/2014	Habibi	
2015/0096135	A1	4/2015	Rosenzweig	
2015/0107528	A1	4/2015	Moeller	
2015/0135455	A1	5/2015	Reusche	
2015/0182013	A1	7/2015	Yao	

FOREIGN PATENT DOCUMENTS

CN	303568187	1/2016
CN	201630367691	2/2017
CN	201630367692	2/2017
CN	201630367975	* 2/2017
JP	D1545602	3/2016
KR	300898876.0000	3/2017

OTHER PUBLICATIONS

Design U.S. Appl. No. 29/508,812, filed Nov. 11, 2014 entitled "Brush," Inventor: Brown et al.
 Design U.S. Appl. No. 29/553,835, filed Feb. 4, 2016 entitled "Brush Handle," Inventor: Morton et al.

Design U.S. Appl. No. 29/553,836, filed Feb. 4, 2016 entitled "Brush," Inventor: Morton et al.
 Design U.S. Appl. No. 29/553,837, filed Feb. 4, 2016 entitled "Brush," Inventor: Morton et al.
 Design U.S. Appl. No. 29/553,838, filed Feb. 4, 2016 entitled "Brush," Inventor: Morton et al.
 Design U.S. Appl. No. 29/552,839, filed Feb. 4, 2016 entitled "Brush," Inventor: Morton et al.
 Goody Straight Talk Cushion Brush, [on-line]; [Internet publication date unknown]; [retrieved from the Internet on Apr. 14, 2017]; URL: <http://goody.com/Products/Styling_Tools/Goody_Straight_Talk_Cushion_Brush?colld=e18f5ccd-1f19-46e2-a228-7310b139a20b&c_id=35a36c88-d359-4104-a53c-dfbfd8452780>; 2 pages.
 Goody Straight Talk Boar . . . Brush . . . , [on-line]; [Internet publication date unknown]; [retrieved from the Internet on Apr. 14, 2017]; URL: <http://www.goody.com/Products/Goody_Refresh/Goody_Straight_Talk_Boar_and_Nylon_Paddle_Hair_Brush_Blue_and_Grey?colld=c482e40d-18fd-4286-a49b-7f3f9802e148&c_id=35a36c88-d359-4104-a53c-dfbfd8452780>; 2 pages.
 Goody Smart Classics Vent Hair Brush; [Internet publication date unknown]; [retrieved from the Internet on Apr. 14, 2017]; URL: <http://www.goody.com/Products/Goody_Refresh/Goody_Smart_Classics_Vent_Hair_Brush?colld=c482e40d-18fd-4286-a49b-7f3f9802e148&c_id=35a36c88-d359-4104-a53c-dfbfd8452780>; 2 pages.
 Goody Detangle It Vent . . . , [on-line]; [Internet publication date unknown]; [retrieved from the Internet on Apr. 14, 2017]; URL: <http://www.goody.com/Products/Goody_Refresh/Goody_Detangle_It_Vent_and_Comb_Set_Purple_and_Grey?colld=c482e40d-18fd-4286-a49b-7f3f9802e148&c_id=35a36c88-d359-4104-a53c-dfbfd8452780>; 2 pages.
 Goody Detangle It Cushion Brush, [on-line]; [Internet publication date unknown]; [retrieved from the Internet on Apr. 14, 2017]; URL: <http://www.goody.com/Products/Styling_Tools/Goody_Detangle_It_Cushion_Brush?colld=e18f5ccd-1f19-46e2-a228-7310b139a20b&c_id=35a36c88-d359-4104-a53c-dfbfd8452780>; 2 pages.
 Goody Detangle It . . . Purple, [on-line]; [Internet publication date unknown]; [retrieved from the Internet on Apr. 14, 2017]; URL: <http://www.goody.com/Products/Goody_Refresh/Goody_Detangle_It_Cushion_Hair_Brush_Purple?colld=c482e40d-18fd-4286-a49b-7f3f9802e148&c_id=35a36c88-d359-4104-a53c-dfbfd8452780>; 2 pages.
 Goody Smart Classics Oval Cushion . . . ; [on-line]; [Internet publication date unknown]; [retrieved from the Internet on Apr. 14, 2017]; URL: <http://www.goody.com/Products/Goody_Refresh/Goody_Smart_Classics_Oval_Cushion_and_Oval_Cushion_Purse_Hair_Brush_Set?colld=c482e40d-18fd-4286-a49b-7f3f9802e148&c_id=35a36c88-d359-4104-a53c-dfbfd8452780>; 2 pages.
 Goody Detangle It Paddle . . . [on-line]; [Internet publication date unknown]; [retrieved from the Internet on Apr. 14, 2017]; URL: <http://www.goody.com/Products/Goody_Refresh/Goody_Detangle_It_Paddle_Hair_Brush_Purple_and_Grey?colld=c482e40d-18fd-4286-a49b-7f3f9802e148&c_id=35a36c88-d359-4104-a53c-dfbfd8452780>; 2 pages.
 Goody Amp It Up Round Hair Brush [on-line]. Publication date unknown; retrieved from the Internet May 1, 2017. URL: <<https://www.walmart.com/ip/Goody-Amp-It-Up-Medium-Round-Hair-Brush/50280015?acti>>. 2 pages.

* cited by examiner

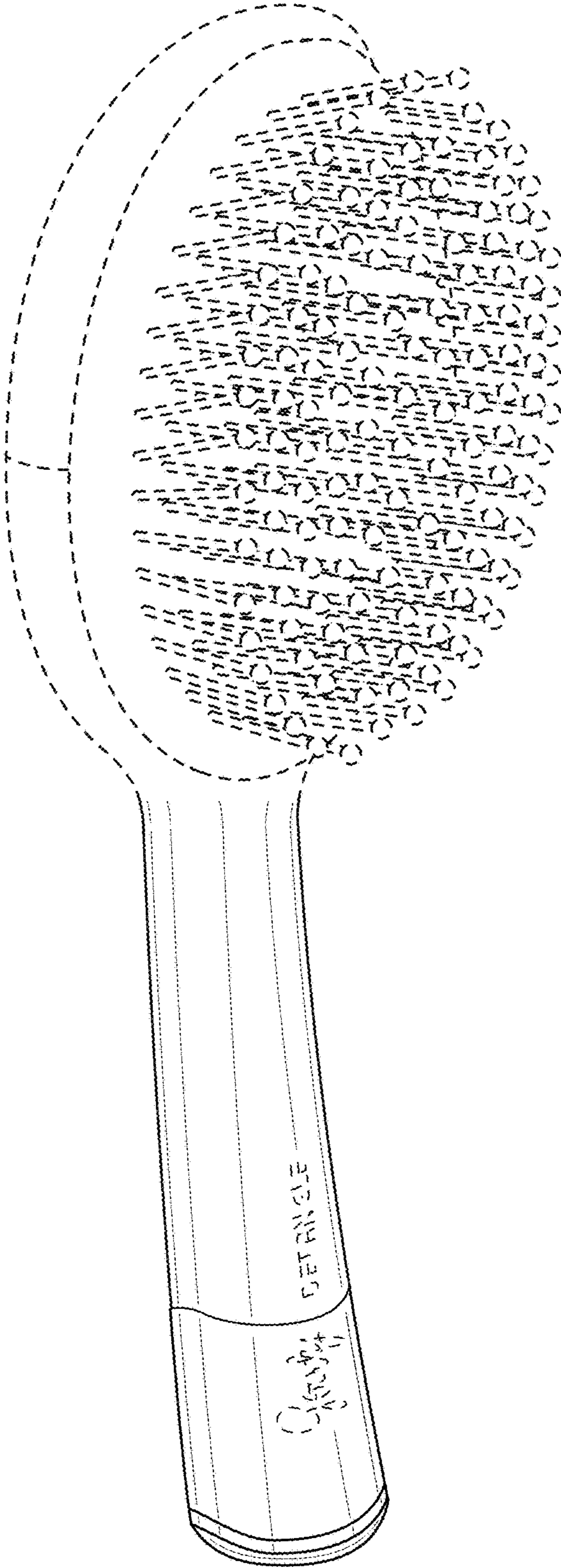

FIG. 1

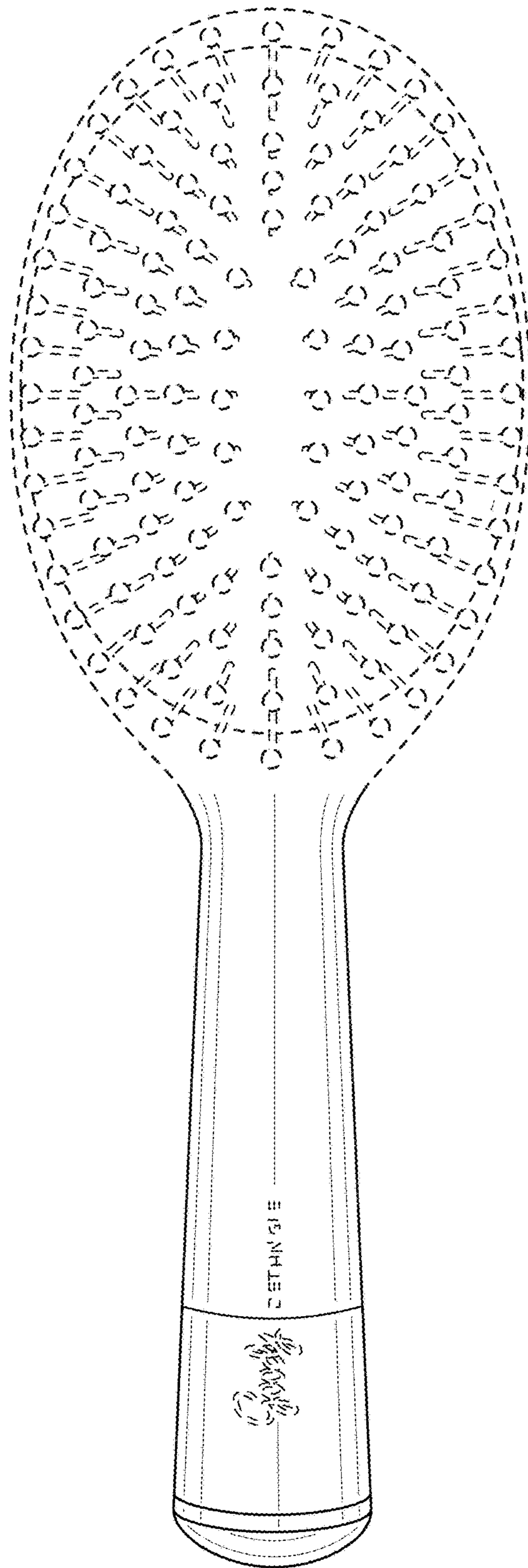

FIG. 2

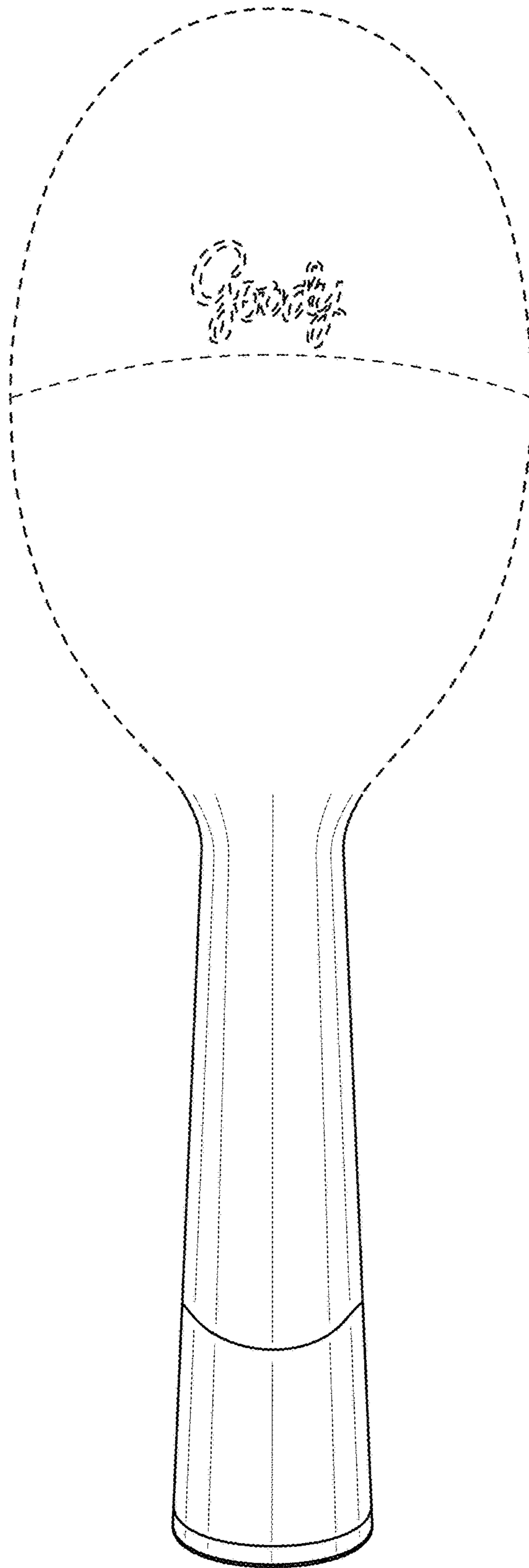

FIG. 3

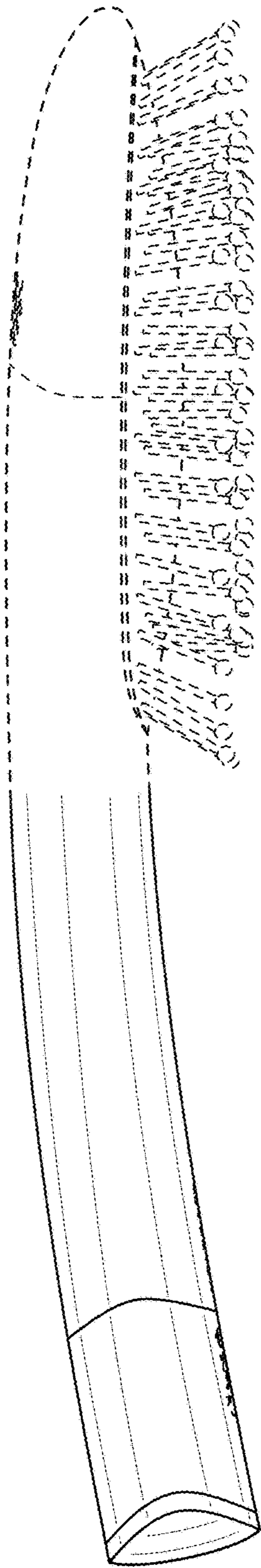

FIG. 4

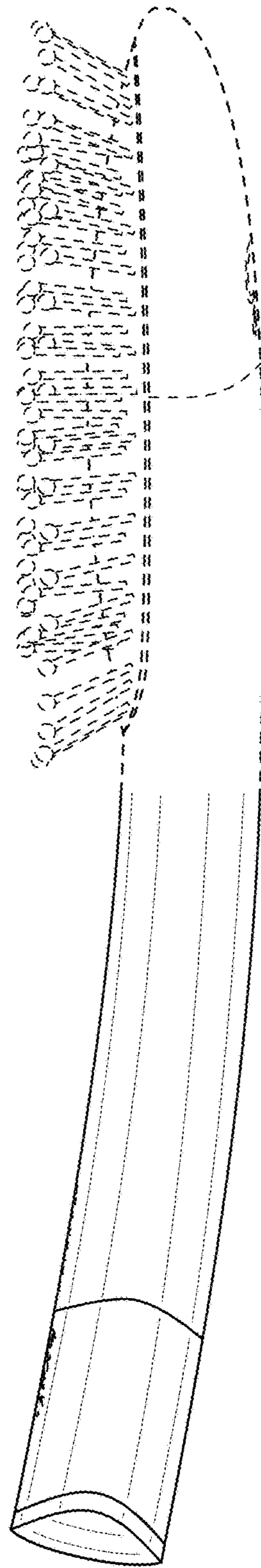

FIG. 5

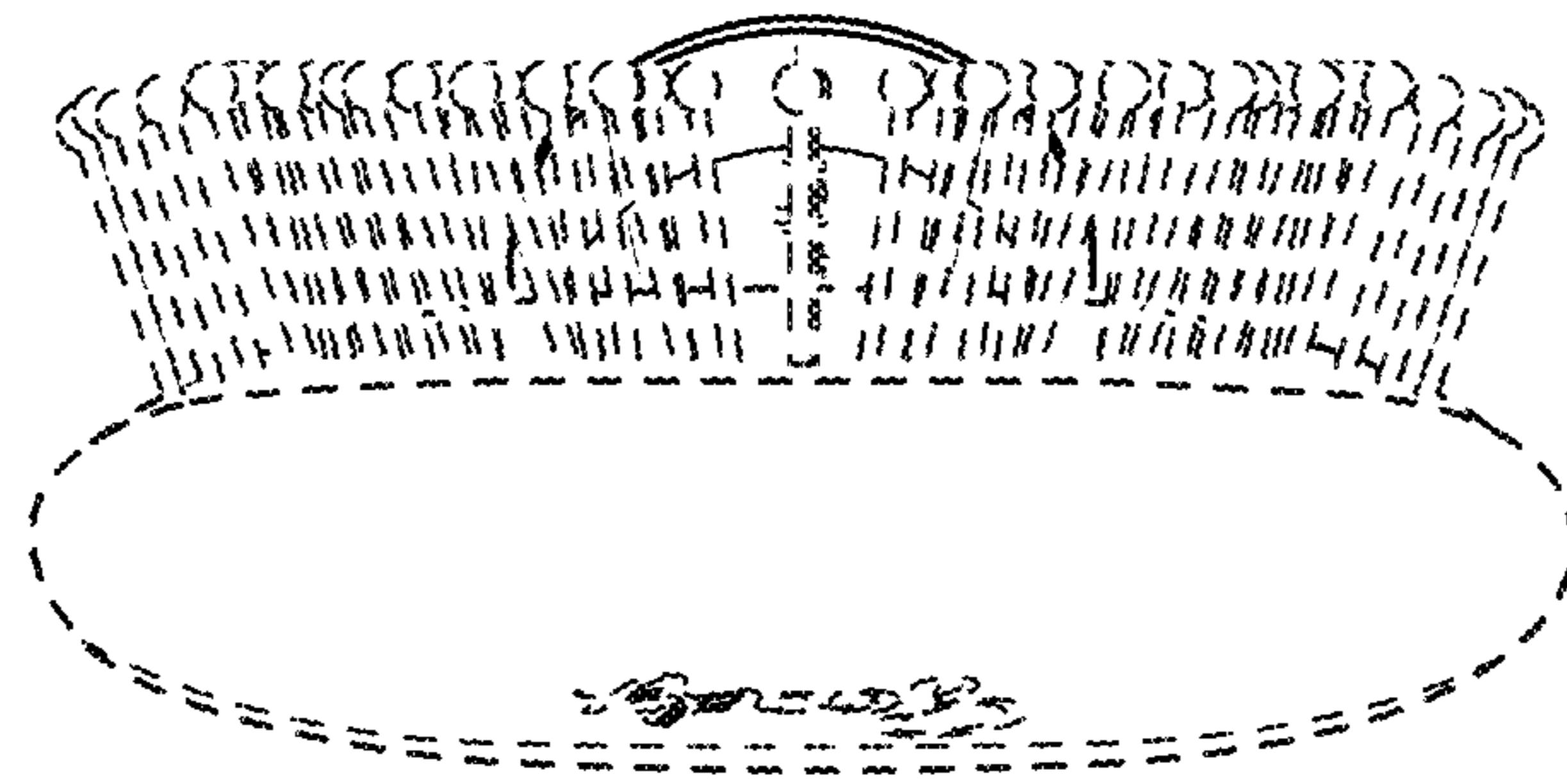

FIG. 6

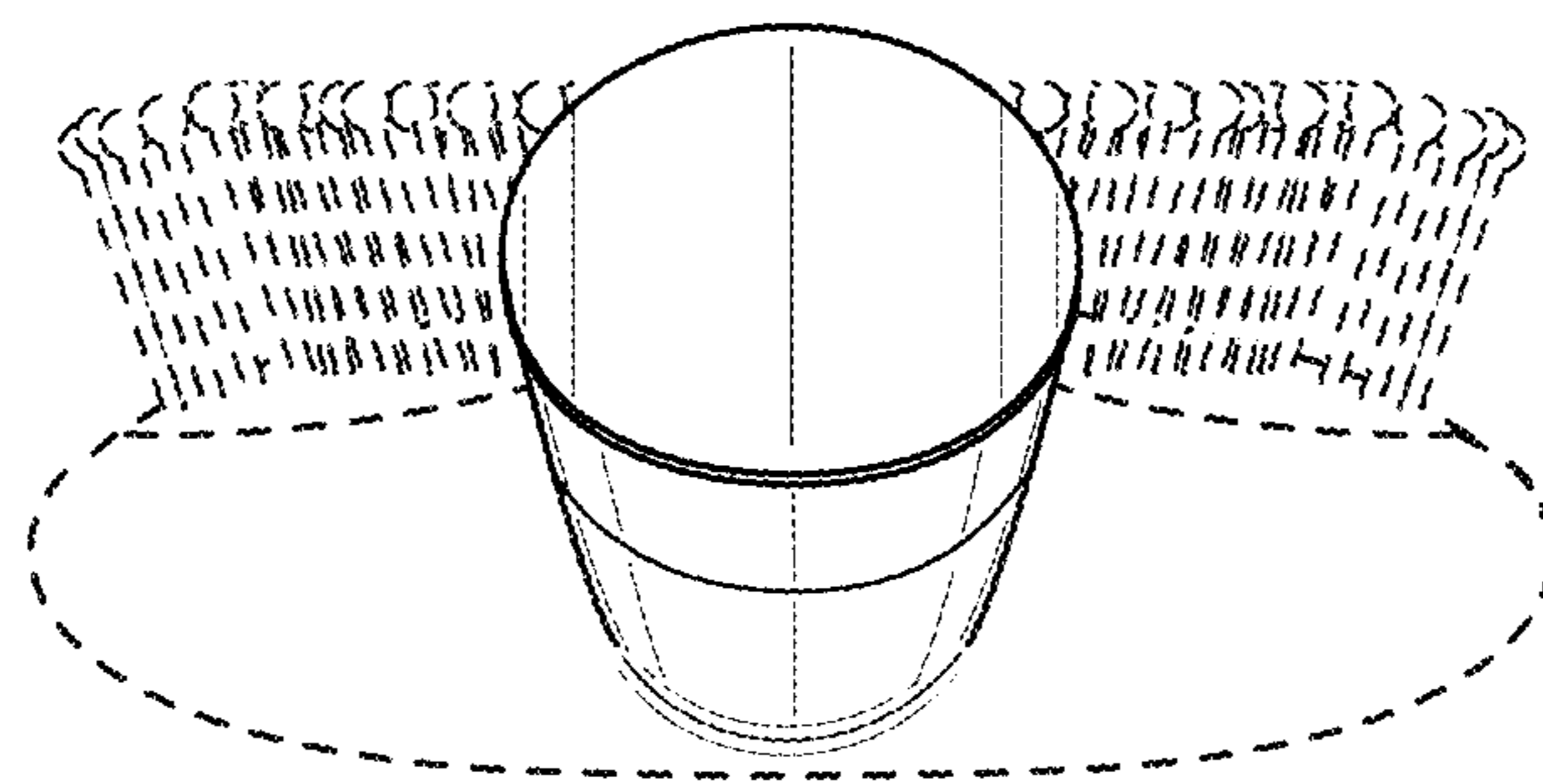

FIG. 7