



US00D792999S

(12) **United States Design Patent**
Sonneman

(10) **Patent No.:** **US D792,999 S**
(45) **Date of Patent:** **** Jul. 25, 2017**

(54) **LIGHT FIXTURE**

- (71) Applicant: **Robert A. Sonneman**, Mamaroneck, NY (US)
- (72) Inventor: **Robert A. Sonneman**, Mamaroneck, NY (US)
- (**) Term: **15 Years**
- (21) Appl. No.: **29/590,633**
- (22) Filed: **Jan. 12, 2017**
- (51) **LOC (10) Cl.** **26-03**
- (52) **U.S. Cl.**
USPC **D26/88**
- (58) **Field of Classification Search**
USPC D26/68, 72, 76, 85, 87, 118, 128
CPC F21S 8/03; F21S 8/033; F21S 8/036; F21S 8/037; F21S 8/04; F21V 21/02
See application file for complete search history.

(56) **References Cited**

U.S. PATENT DOCUMENTS

D39,323 S *	5/1908	Phelps	D26/128
1,087,574 A *	2/1914	Dawes	G09F 13/04 40/572
D46,952 S *	2/1915	Long	D26/128
D49,292 S *	6/1916	West	D26/128
D50,094 S *	12/1916	Dawes	D26/128
D161,830 S *	2/1951	Grossman	D26/128
D222,105 S *	9/1971	Encausse	D27/156
D323,904 S *	2/1992	Camino	D26/128
D541,970 S *	5/2007	Blackman	D26/81
D626,272 S *	10/2010	Verelst	D26/85
D781,484 S *	3/2017	Urquiola	D26/85

OTHER PUBLICATIONS

Possini Euro Ritzville LED swag pendant. Found at eurostylelighting.com visited May 15, 2017.*
Cantina Large LED pendant from sonneman a way of light. website visited May 15, 2017. (2 pages).*

* cited by examiner

Primary Examiner — Clare E Heflin

(74) *Attorney, Agent, or Firm* — Gottlieb, Rackman & Reisman, P.C.

(57) **CLAIM**

The ornamental design for a light fixture, as shown and described.

DESCRIPTION

FIG. 1 is a perspective view of the light fixture showing my new design;

FIG. 2 is a front elevational view thereof;

FIG. 3 is a rear elevational view thereof;

FIG. 4 is a right side elevational view thereof;

FIG. 5 is a left side elevational view thereof;

FIG. 6 is a top plan view thereof; and,

FIG. 7 is a bottom plan view thereof.

The broken lines shown in the drawings are included for the purpose of illustrating portions of the article that form no part of the claimed design.

A portion of the light fixture is shown with symbolic breaks in its length. The appearance of any portion of the article between the break lines forms no part of the claimed design.

1 Claim, 5 Drawing Sheets

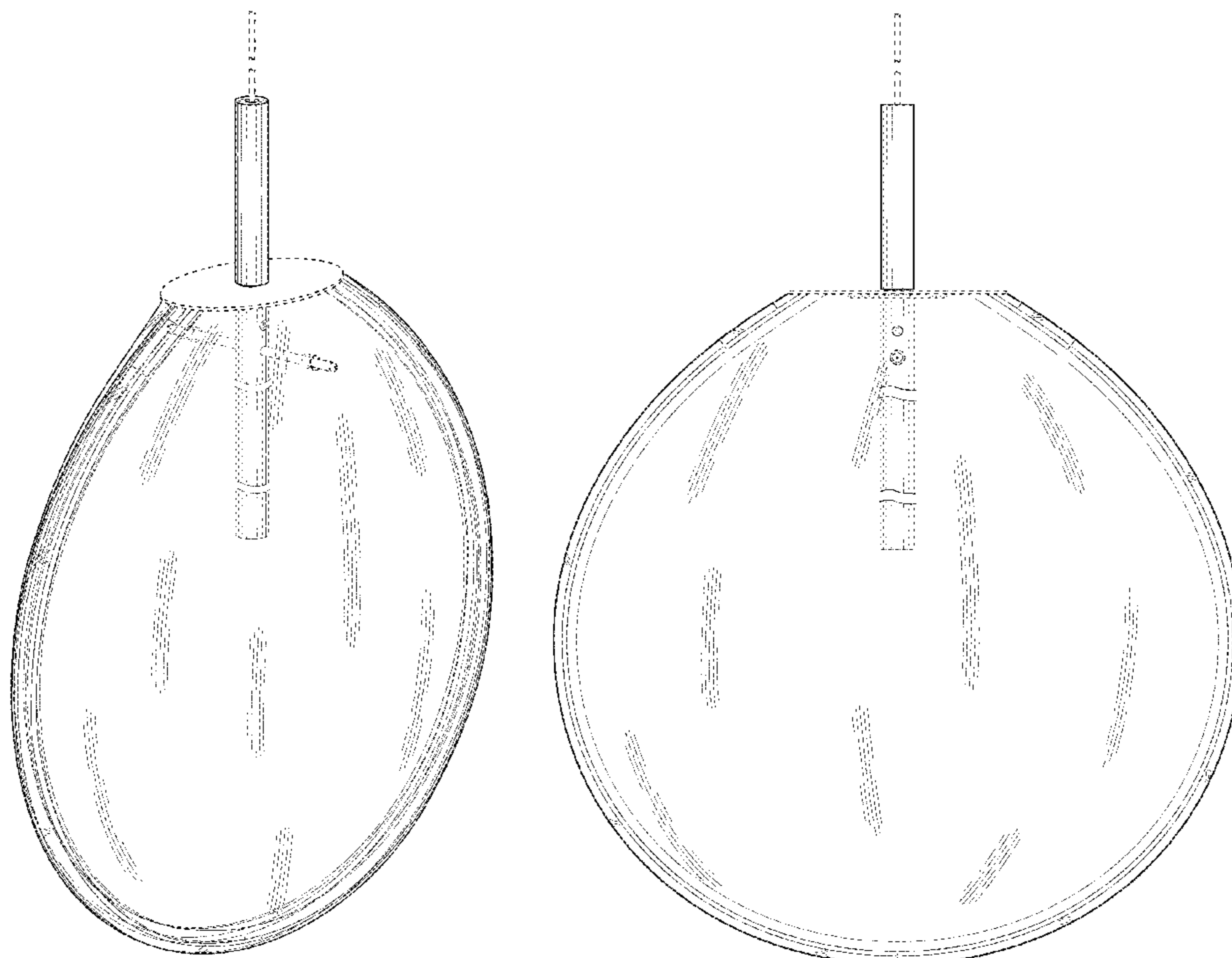

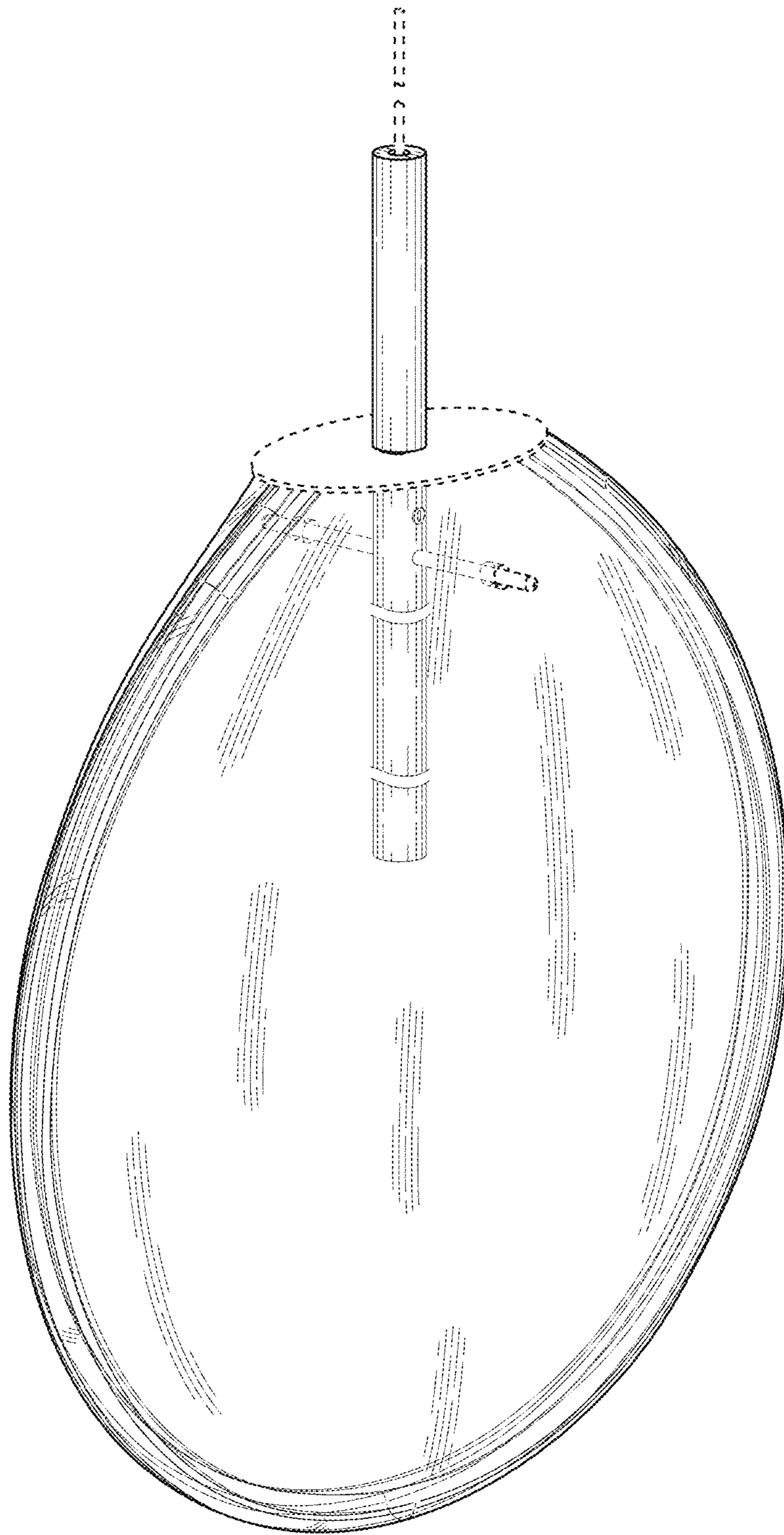

FIG. 1

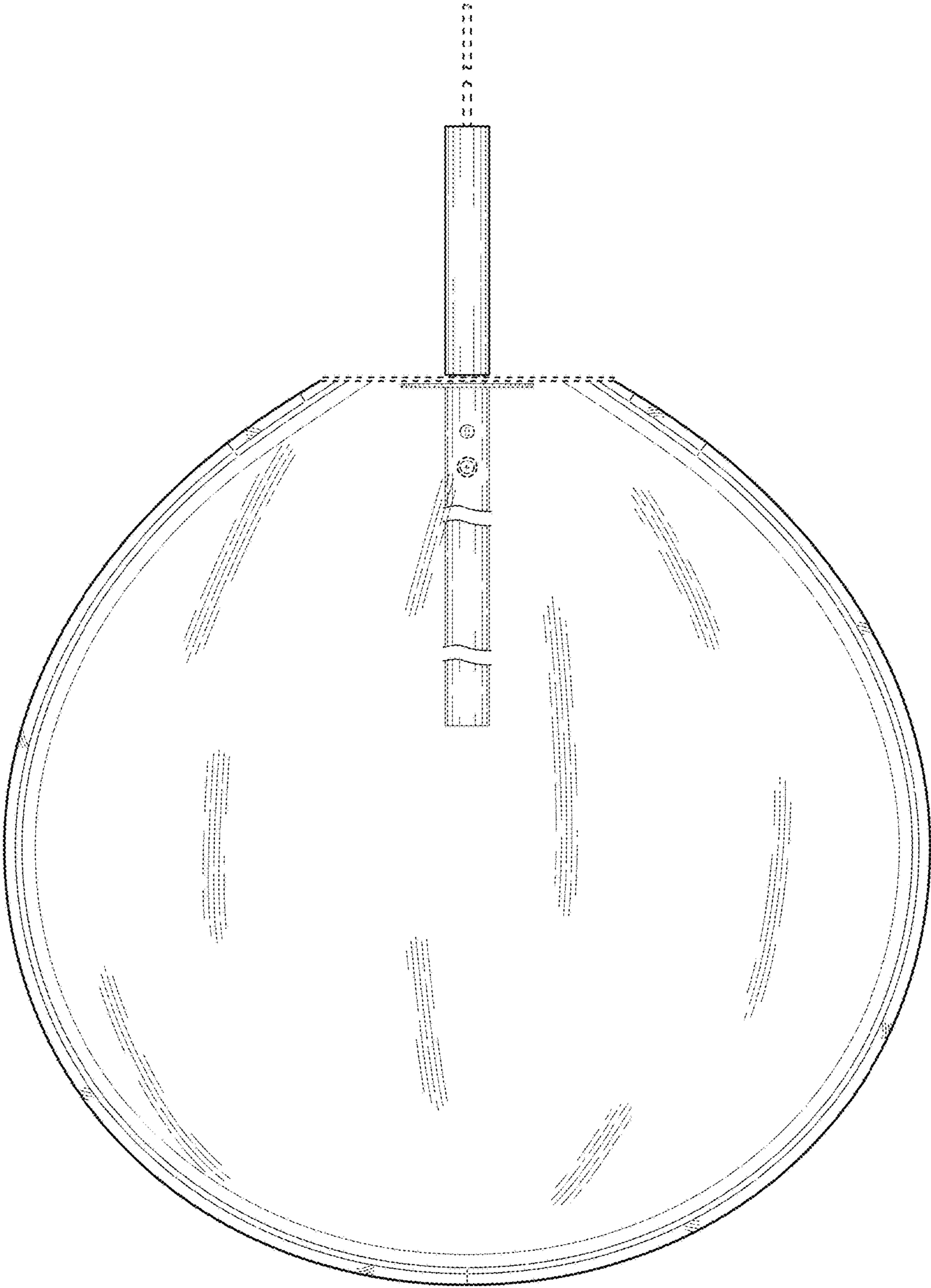

FIG. 2

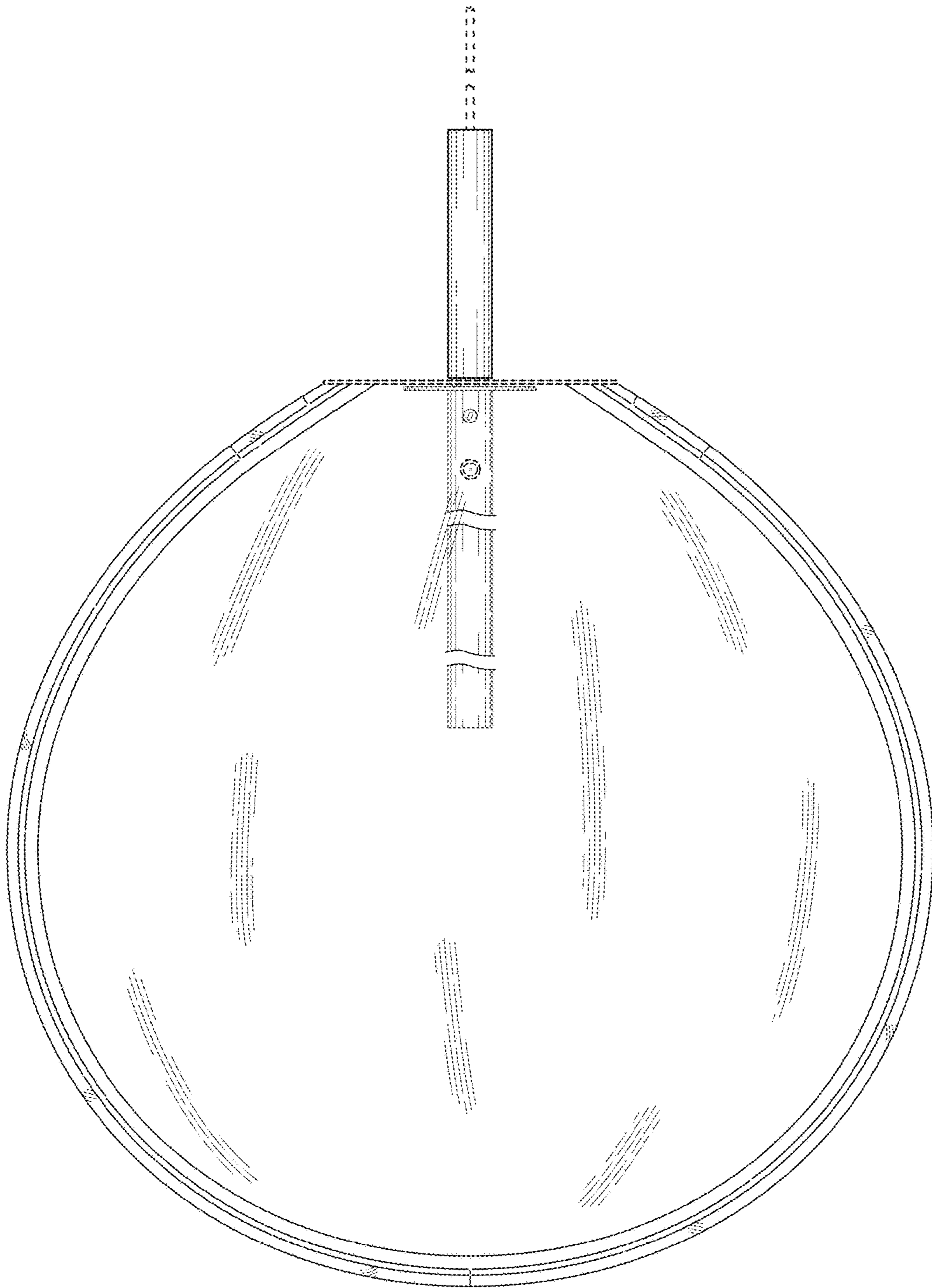

FIG. 3

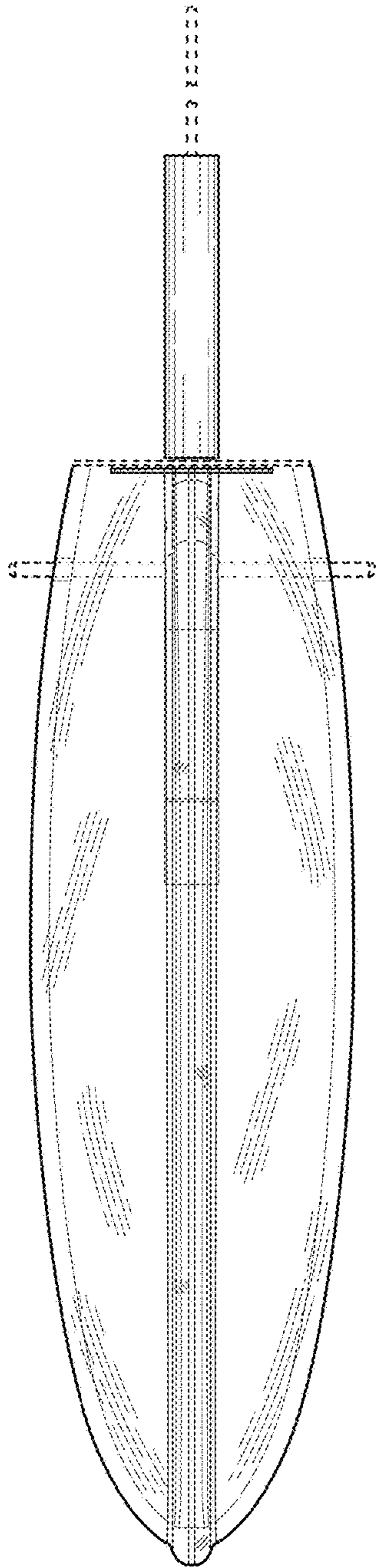

FIG. 4

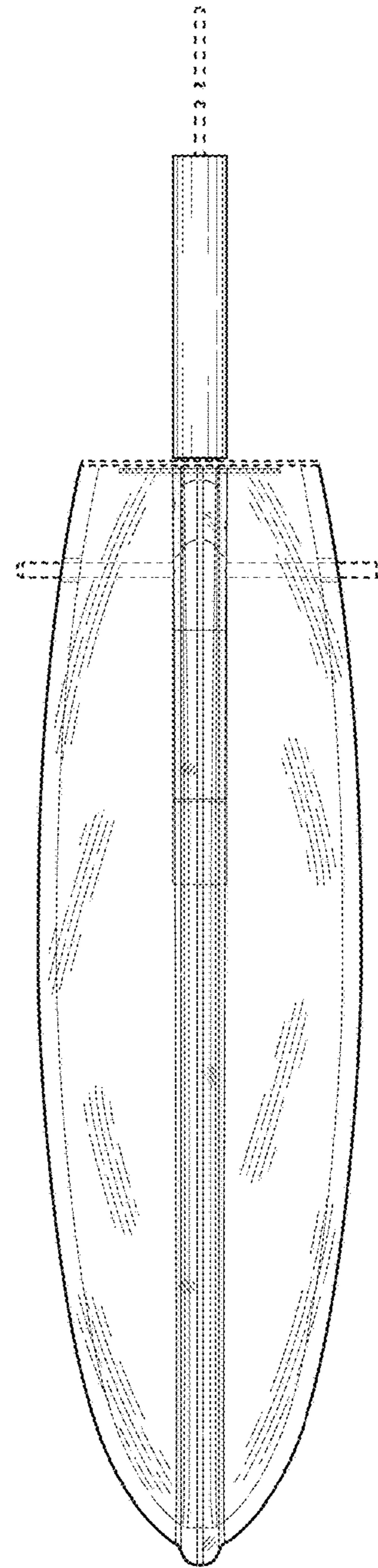

FIG. 5

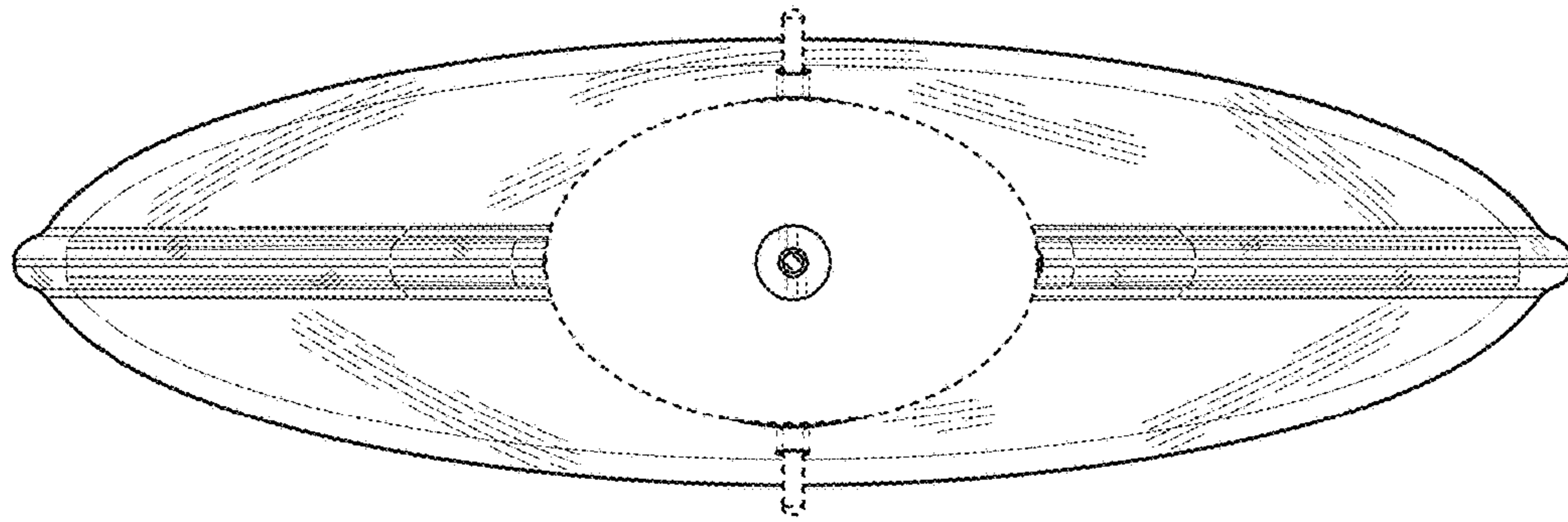

FIG. 6

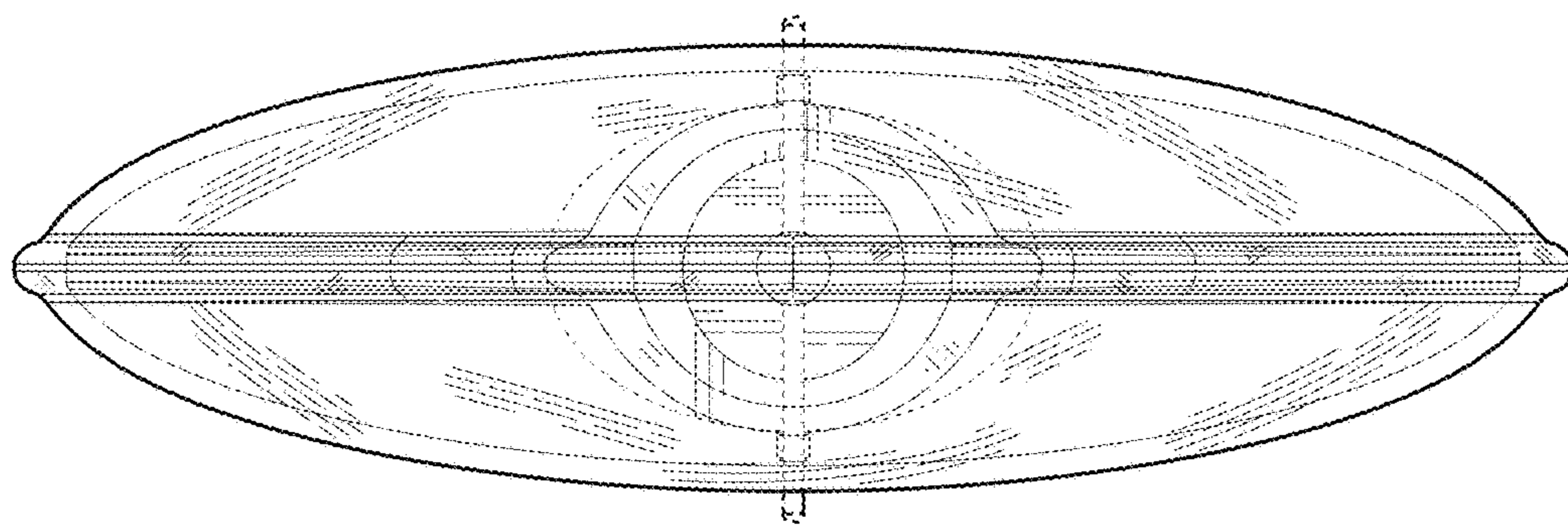

FIG. 7