

US00D792973S

(12) **United States Design Patent**  
**Matheny**

(10) **Patent No.:** **US D792,973 S**  
(45) **Date of Patent:** **\*\* Jul. 25, 2017**

- (54) **NASAL SUPPORT DEVICE**
- (71) Applicant: **Matheny ENTERprises, LLC**, Plano, TX (US)
- (72) Inventor: **Keith E. Matheny**, Plano, TX (US)
- (73) Assignee: **Matheny ENTERprises, LLC**, Plano, TX (US)
- (\*\*) Term: **15 Years**
- (21) Appl. No.: **29/546,253**
- (22) Filed: **Nov. 20, 2015**

8,709,080	B2 *	4/2014	Marten	.....	A61B 17/0057
					623/9
8,740,929	B2 *	6/2014	Gopferich	.....	A61F 2/186
					424/425
D745,969	S *	12/2015	Matheny	.....	D24/155
2005/0203450	A1 *	9/2005	Shippert	.....	A61F 5/08
					602/7
2006/0142736	A1 *	6/2006	Hissink	.....	A61F 11/002
					604/540
2012/0071913	A1 *	3/2012	Tamez	.....	A61F 5/08
					606/199
2013/0338700	A1 *	12/2013	Matheny	.....	A61M 35/00
					606/199

\* cited by examiner

*Primary Examiner* — Charles Hanson

**Related U.S. Application Data**

- (62) Division of application No. 29/432,554, filed on Sep. 17, 2012, now Pat. No. Des. 745,969.
- (51) **LOC (10) Cl.** ..... **24-02**
- (52) **U.S. Cl.**  
USPC ..... **D24/155**
- (58) **Field of Classification Search**  
USPC ..... D24/155-157  
CPC ..... A61F 5/08; A61F 2/186; A61F 11/002  
See application file for complete search history.

(57) **CLAIM**

The ornamental design of a nasal support device, substantially shown and described.

**DESCRIPTION**

FIG. 1 is a top perspective view of an embodiment of a nasal support device;  
 FIG. 2 is a bottom perspective view thereof;  
 FIG. 3 is a first side view thereof;  
 FIG. 4 is a second side view thereof, wherein the second side view is opposed to the first side view;  
 FIG. 5 is a third side view thereof;  
 FIG. 6 is a fourth side view thereof, wherein the fourth side view is opposed to the third side view;  
 FIG. 7 is a top view thereof; and,  
 FIG. 8 is a bottom view thereof.

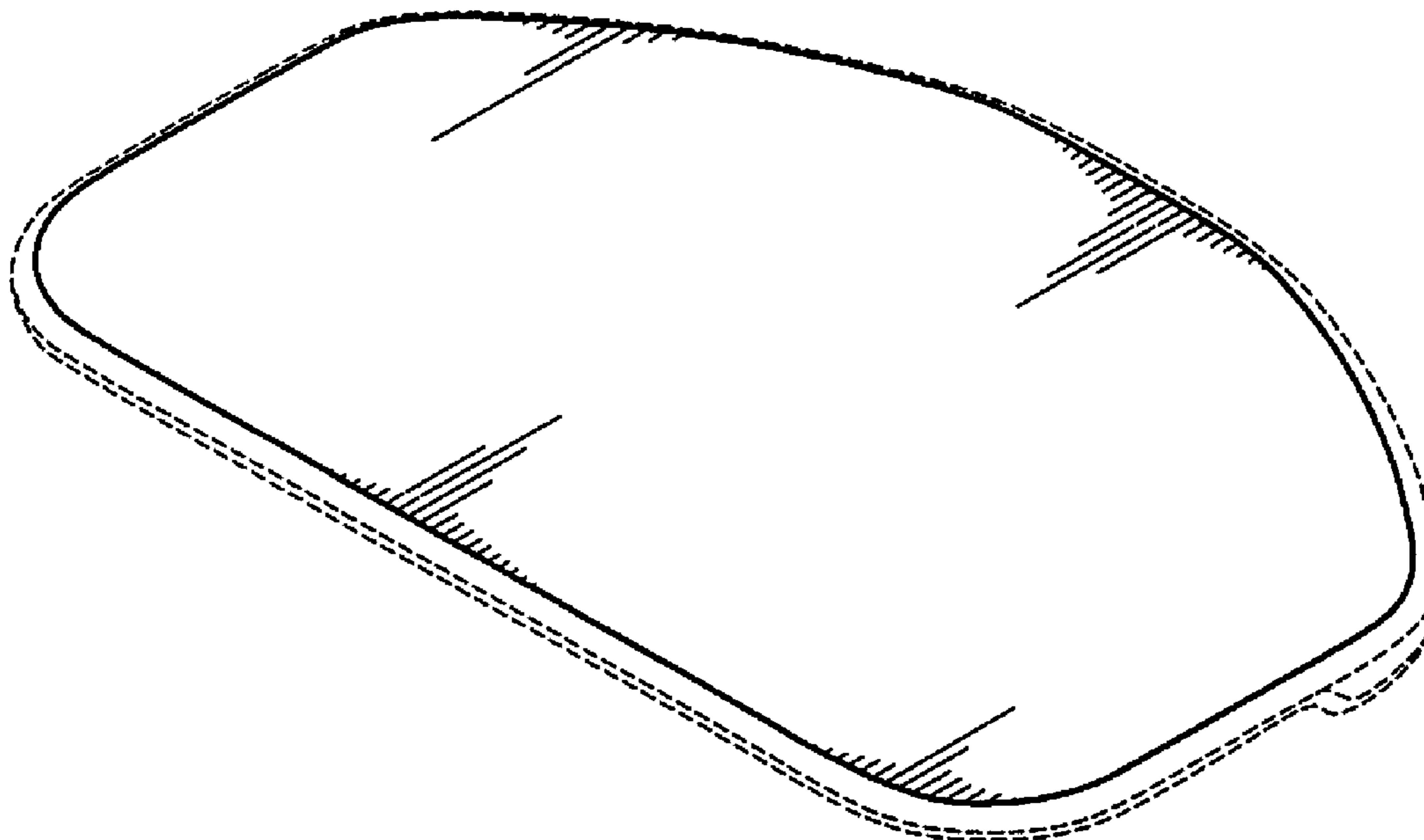
The broken line showing is included for the purpose of illustrating unclaimed subject matter and forms no part of the claimed design.

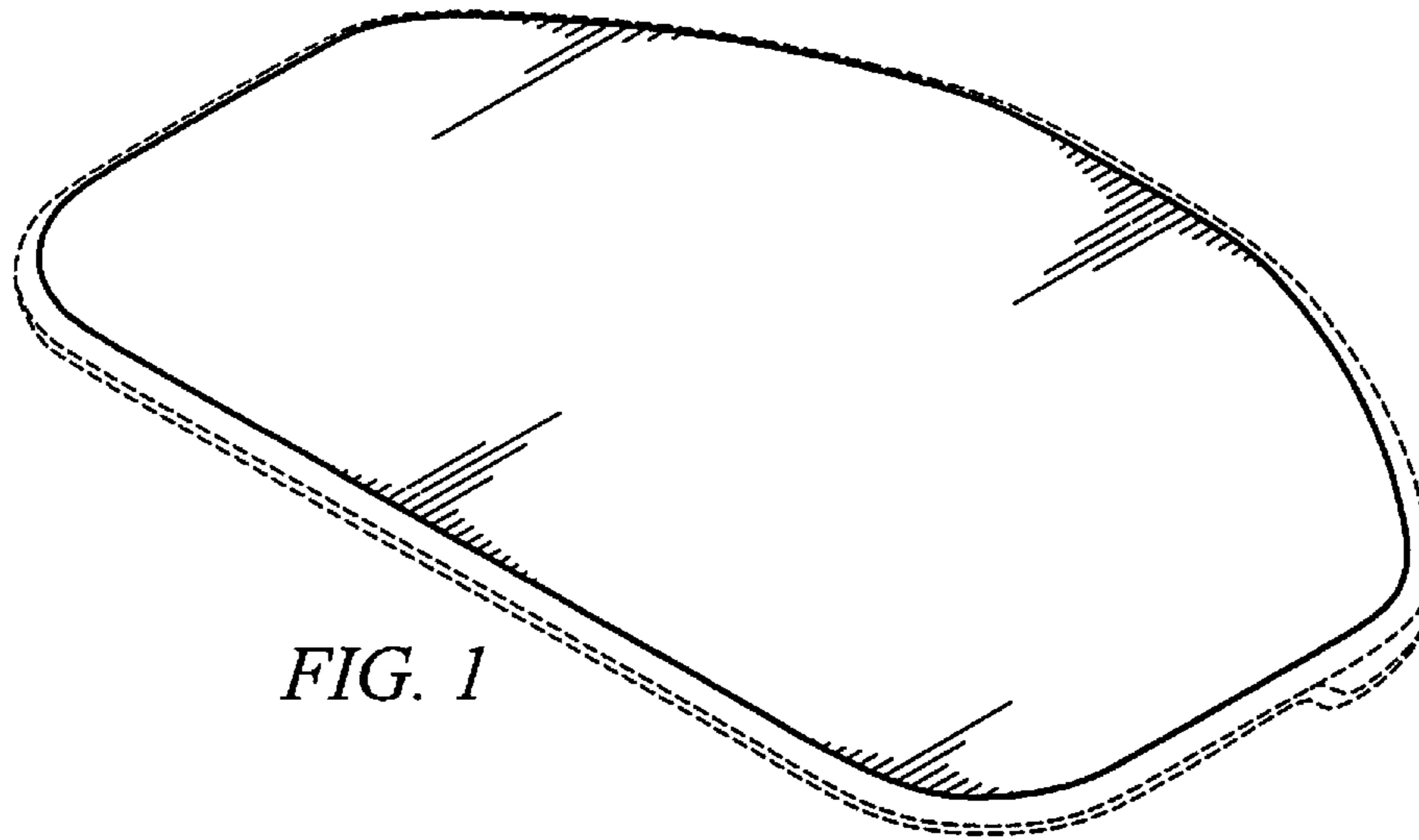
(56) **References Cited**

**U.S. PATENT DOCUMENTS**

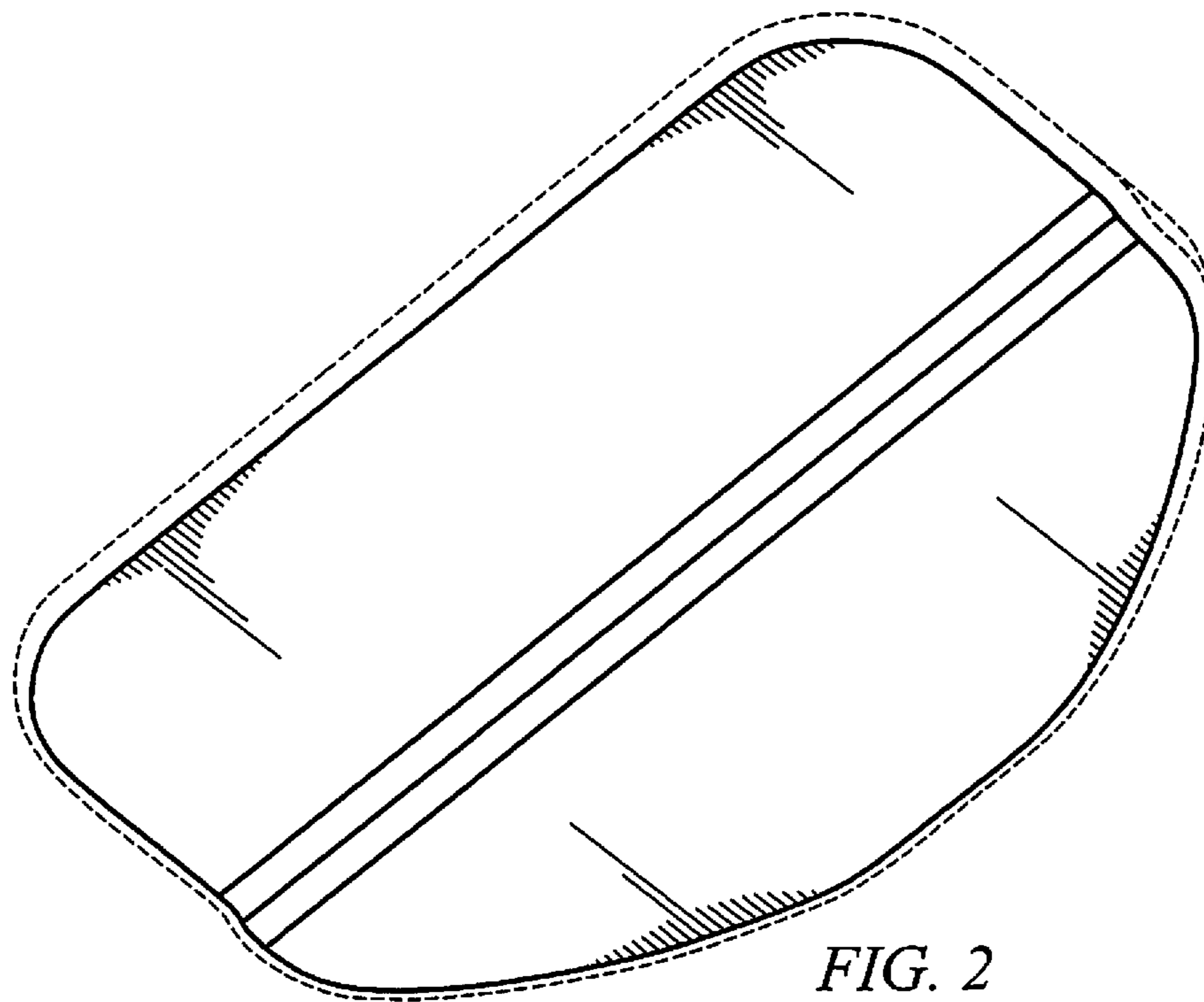
5,601,594	A *	2/1997	Best	.....	A61F 5/08
					606/196
D468,826	S *	1/2003	Doyle	.....	D24/128
7,022,890	B2 *	4/2006	Sessions	.....	A61F 13/12
					602/46
8,585,753	B2 *	11/2013	Scanlon	.....	A61F 2/07
					623/1.42

**1 Claim, 3 Drawing Sheets**

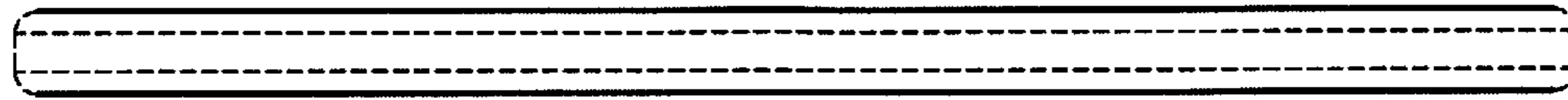




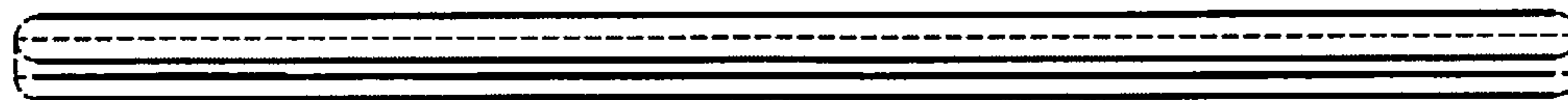
*FIG. 1*



*FIG. 2*



*FIG. 3*



*FIG. 4*



*FIG. 5*



*FIG. 6*

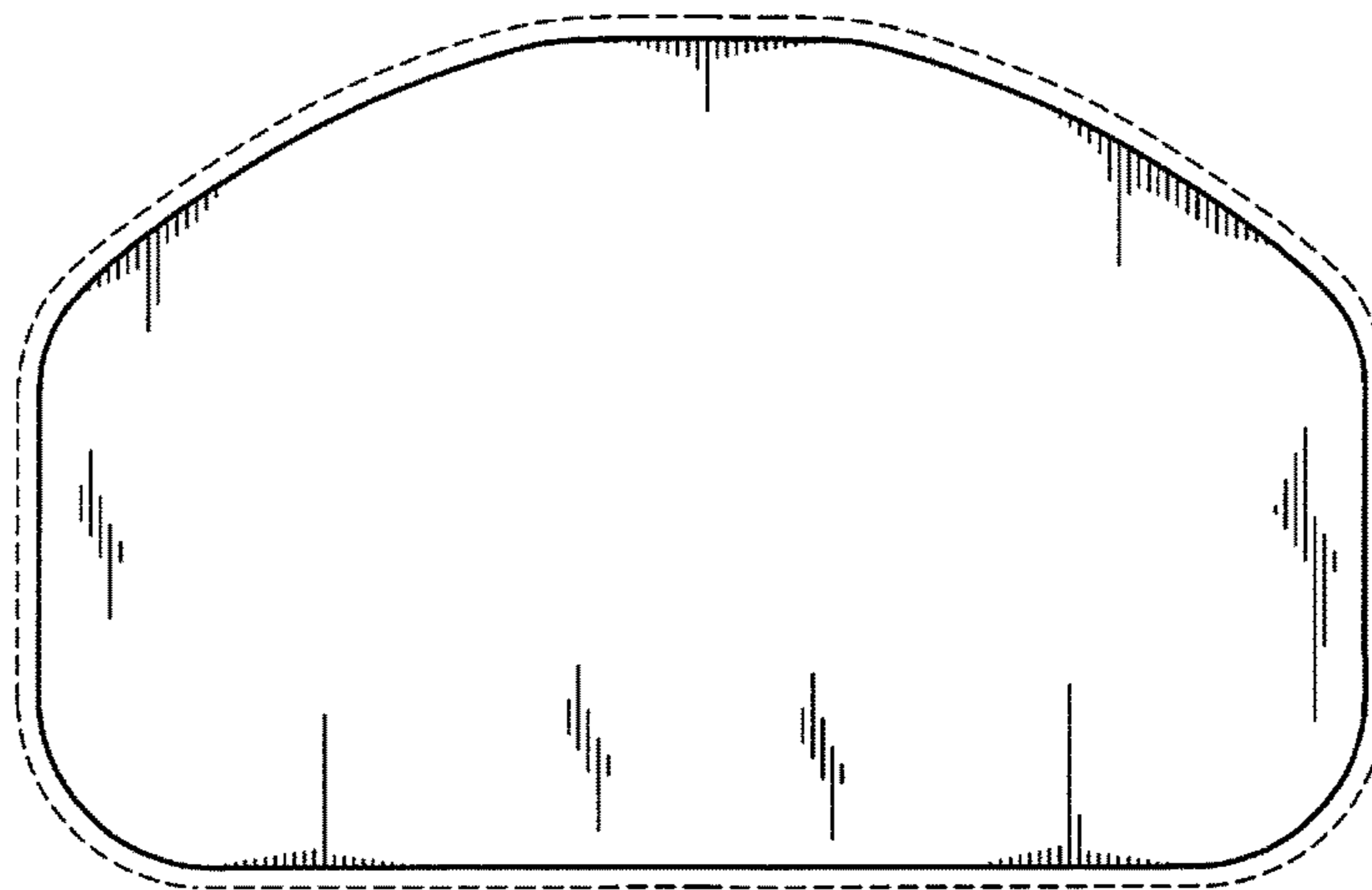


FIG. 7

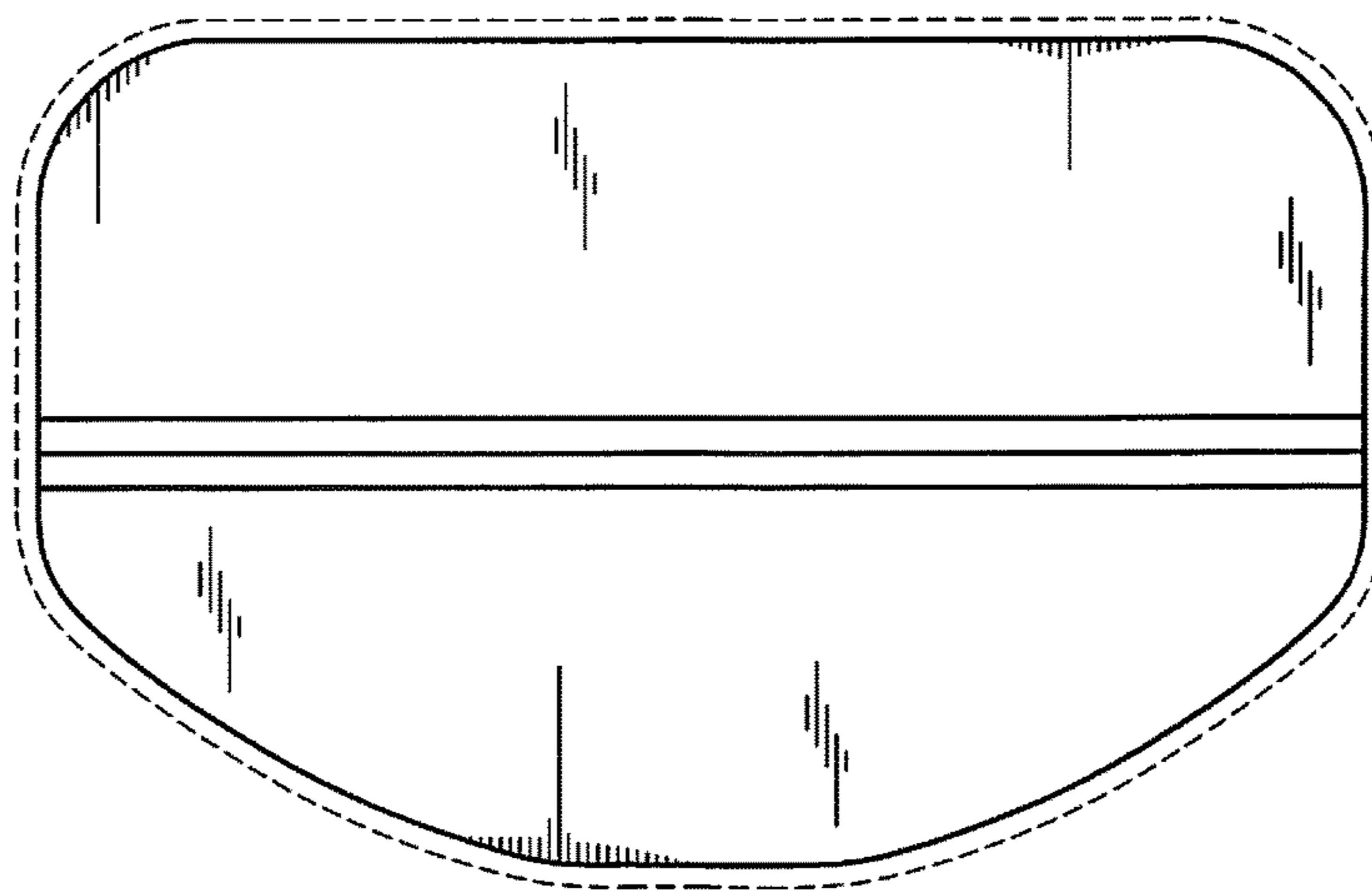


FIG. 8