



US00D792971S

(12) **United States Design Patent**  
**Greenizen et al.**

(10) **Patent No.:** **US D792,971 S**  
(45) **Date of Patent:** **\*\* Jul. 25, 2017**

- (54) **CLAMP**
- (71) Applicant: **EMD Millipore Corporation**, Billerica, MA (US)
- (72) Inventors: **Kurt E. Greenizen**, Atkinson, NH (US); **Christopher A. Scott**, Westford, MA (US); **Paul Sydlowski**, Danvers, MA (US)
- (73) Assignee: **EMD Millipore Corporation**, Billerica, MA (US)
- (\*\*) Term: **15 Years**
- (21) Appl. No.: **29/563,491**
- (22) Filed: **May 5, 2016**
- (51) **LOC (10) Cl.** ..... **24-02**
- (52) **U.S. Cl.**  
USPC ..... **D24/143**; D8/395
- (58) **Field of Classification Search**  
USPC .... D24/143, 133, 128; D8/72-73, 395, 356, D8/394  
CPC ... A61B 17/0487; A61B 17/068; A61B 17/08; A61B 17/122; B01D 29/085; B01D 29/093; B01D 29/096; A61G 7/0503; F16M 11/2064; F16M 13/02; F16M 13/022  
See application file for complete search history.

- 7,798,333 B2 \* 9/2010 Zuk, Jr. .... B01D 29/085 210/406
- 8,157,104 B2 \* 4/2012 Kane ..... B01D 29/085 210/406
- 8,978,897 B2 \* 3/2015 Cai ..... B01D 29/085 210/406
- D750,476 S \* 3/2016 Huang ..... D8/395

**FOREIGN PATENT DOCUMENTS**

BE	613310	A1	5/1962
CN	202133578	U	2/2012
CN	102580376	A	7/2012
CN	202620830	U	12/2012
CN	103203128	A	7/2013
CN	104841194	A	8/2015
CN	204745793	U	11/2015
DE	2552519	A1	5/1977
DE	3502815	A1	7/1986

\* cited by examiner

*Primary Examiner* — Wan Laymon

(74) *Attorney, Agent, or Firm* — Nields, Lemack & Frame, LLC

(57) **CLAIM**

The ornamental design for a clamp, as shown and described.

**DESCRIPTION**

FIG. 1 is a front perspective view of the clamp;  
 FIG. 2 is a rear perspective view of the clamp;  
 FIG. 3 is an additional perspective view from below the clamp;  
 FIG. 4 is a right side view of the clamp (the left side view is a mirror image of the right side view and is not shown);  
 FIG. 5 is a top view of the clamp;  
 FIG. 6 is a bottom view of the clamp;  
 FIG. 7 is a rear view of the clamp; and,  
 FIG. 8 is a front view of the clamp.

**1 Claim, 8 Drawing Sheets**

- (56) **References Cited**  
U.S. PATENT DOCUMENTS  
4,301,010 A 11/1981 Eddleman et al.  
D380,145 S \* 6/1997 Rumpel ..... D8/395  
D416,789 S \* 11/1999 Pernu ..... D8/395  
D438,453 S \* 3/2001 Nelson ..... D8/395  
D447,564 S \* 9/2001 Stewart, Jr. .... D24/143

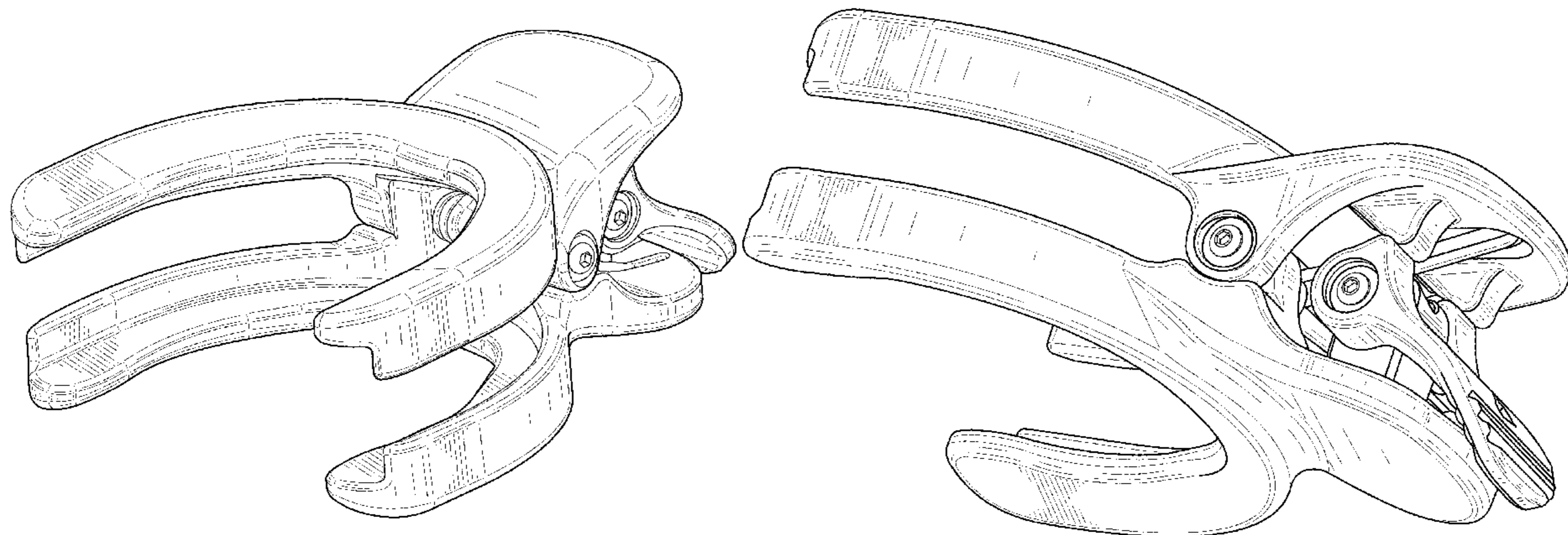

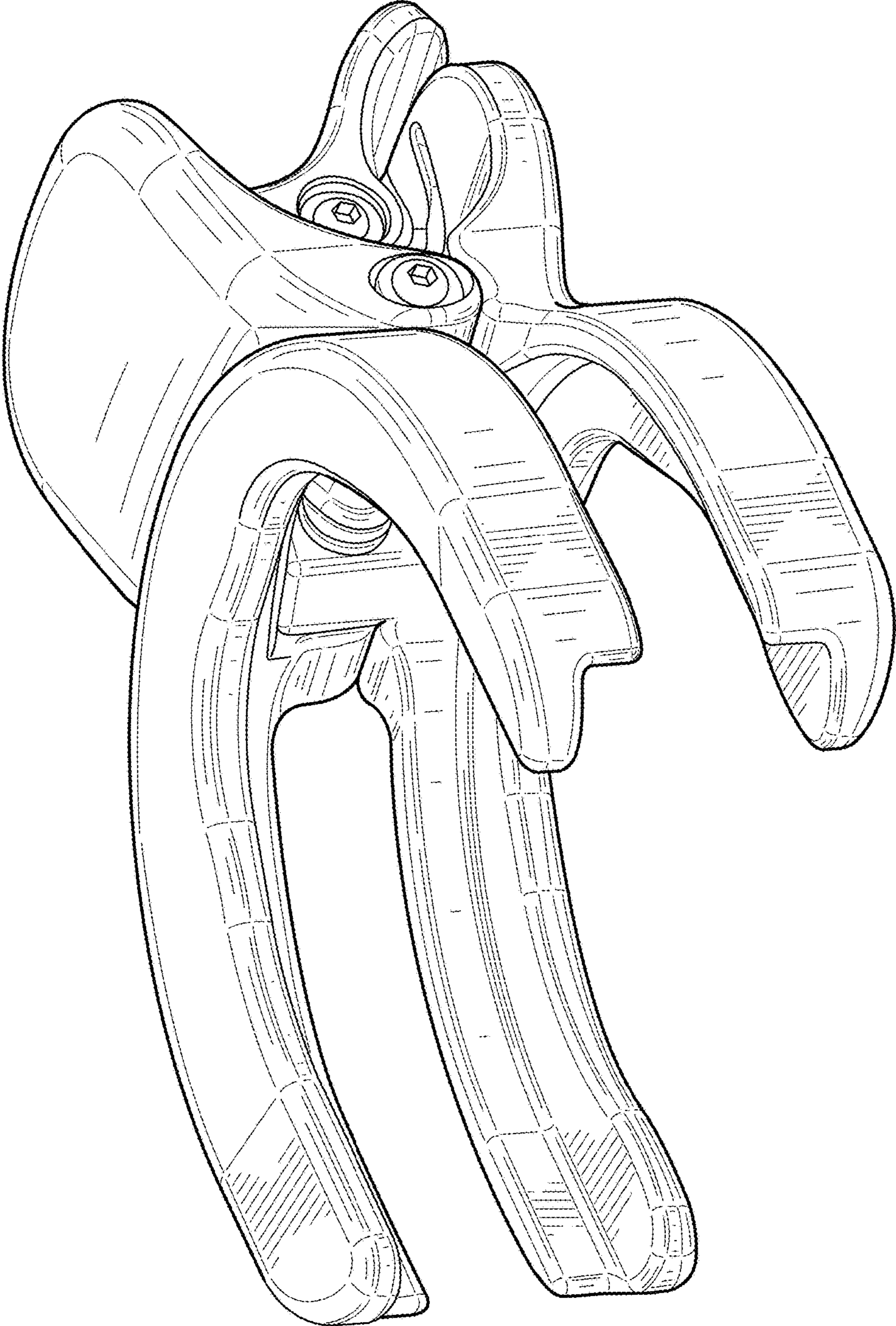

FIG. 1

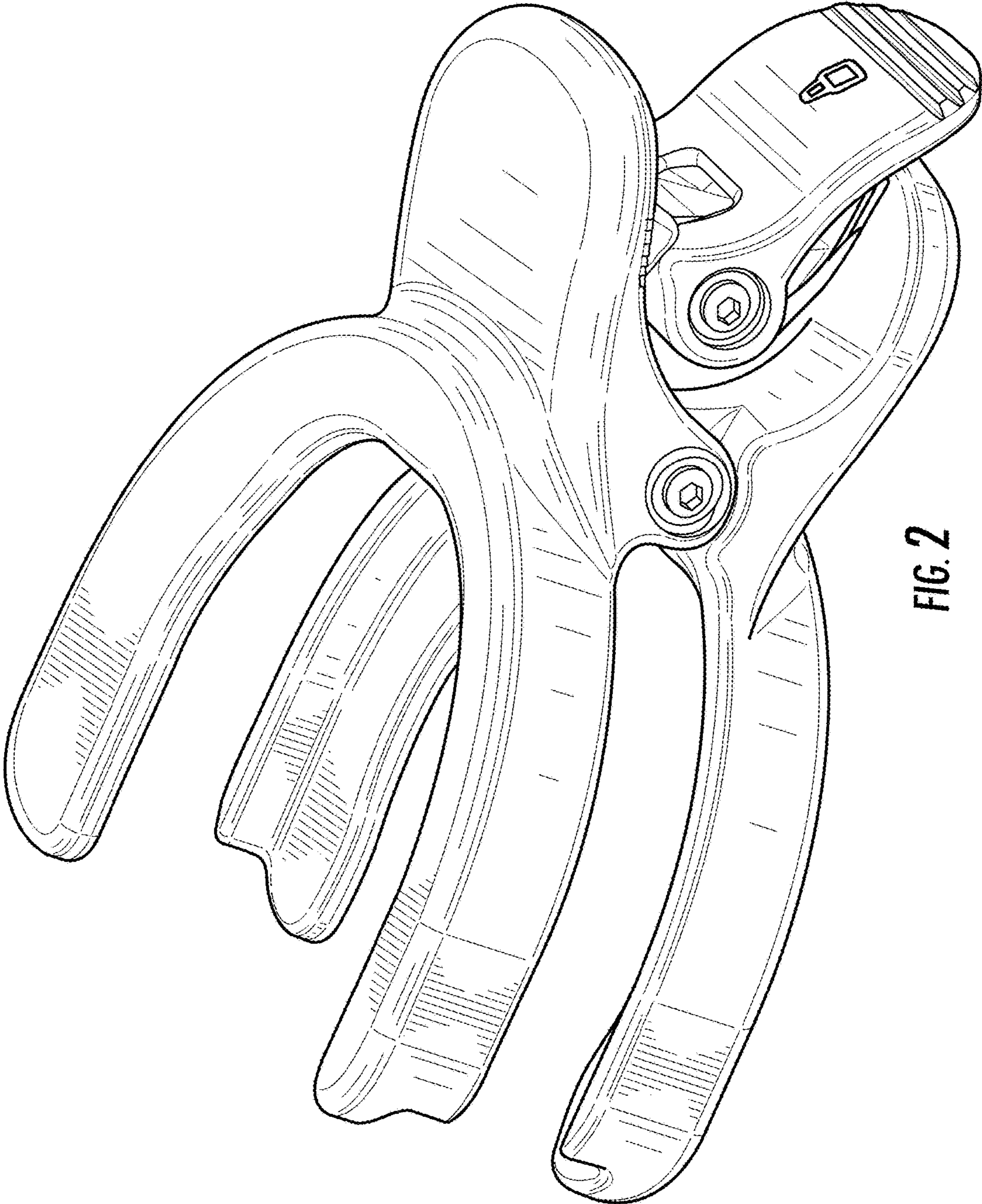

FIG. 2

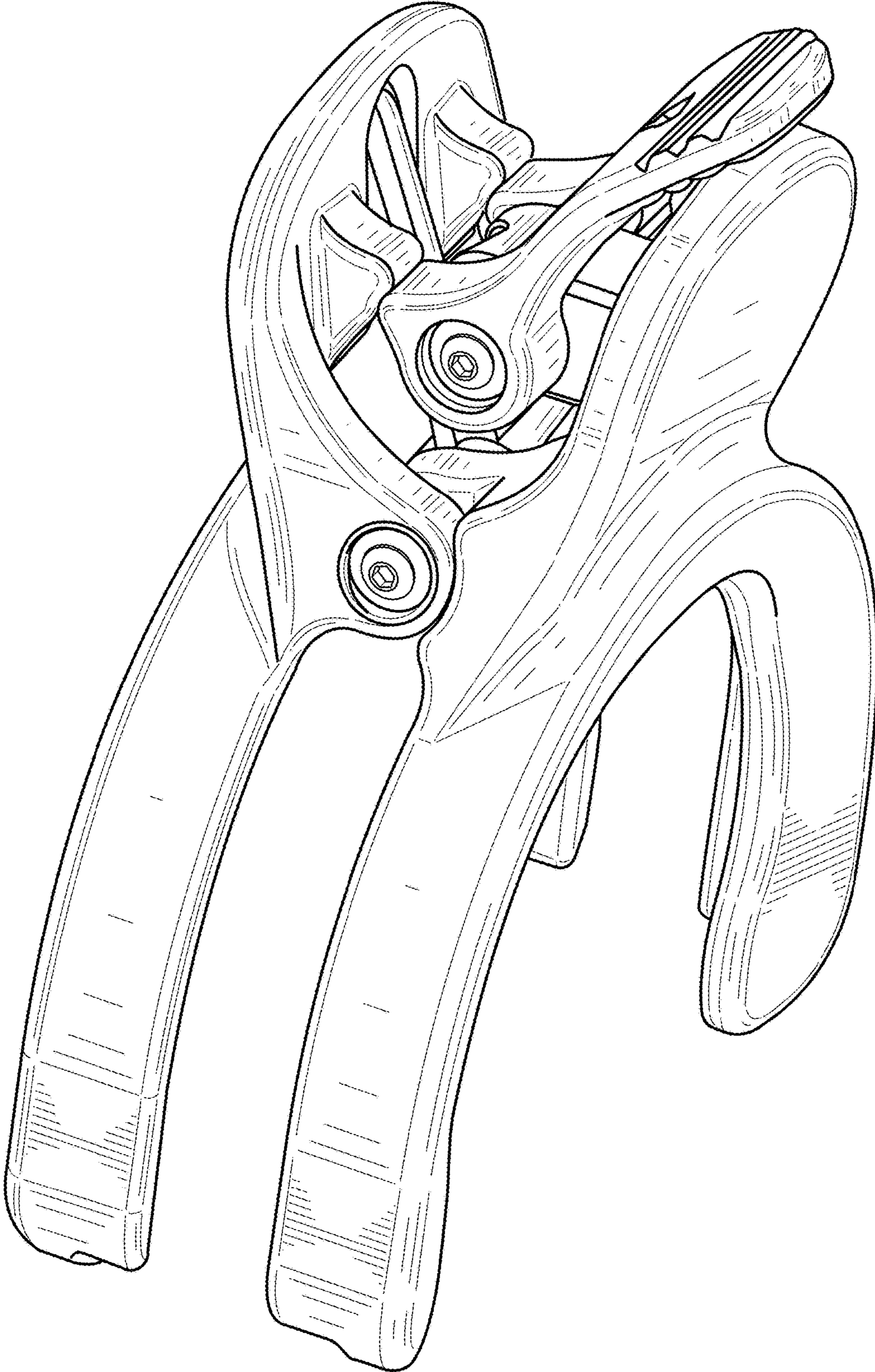

FIG. 3

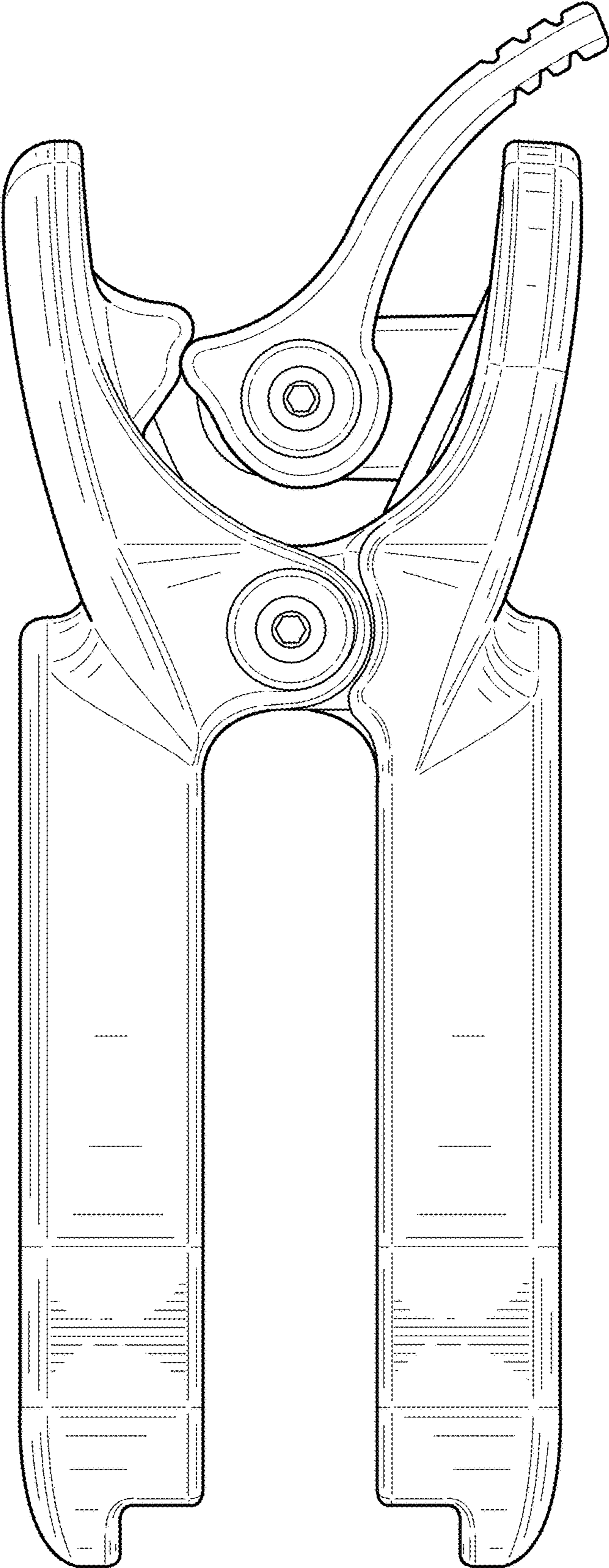

FIG. 4

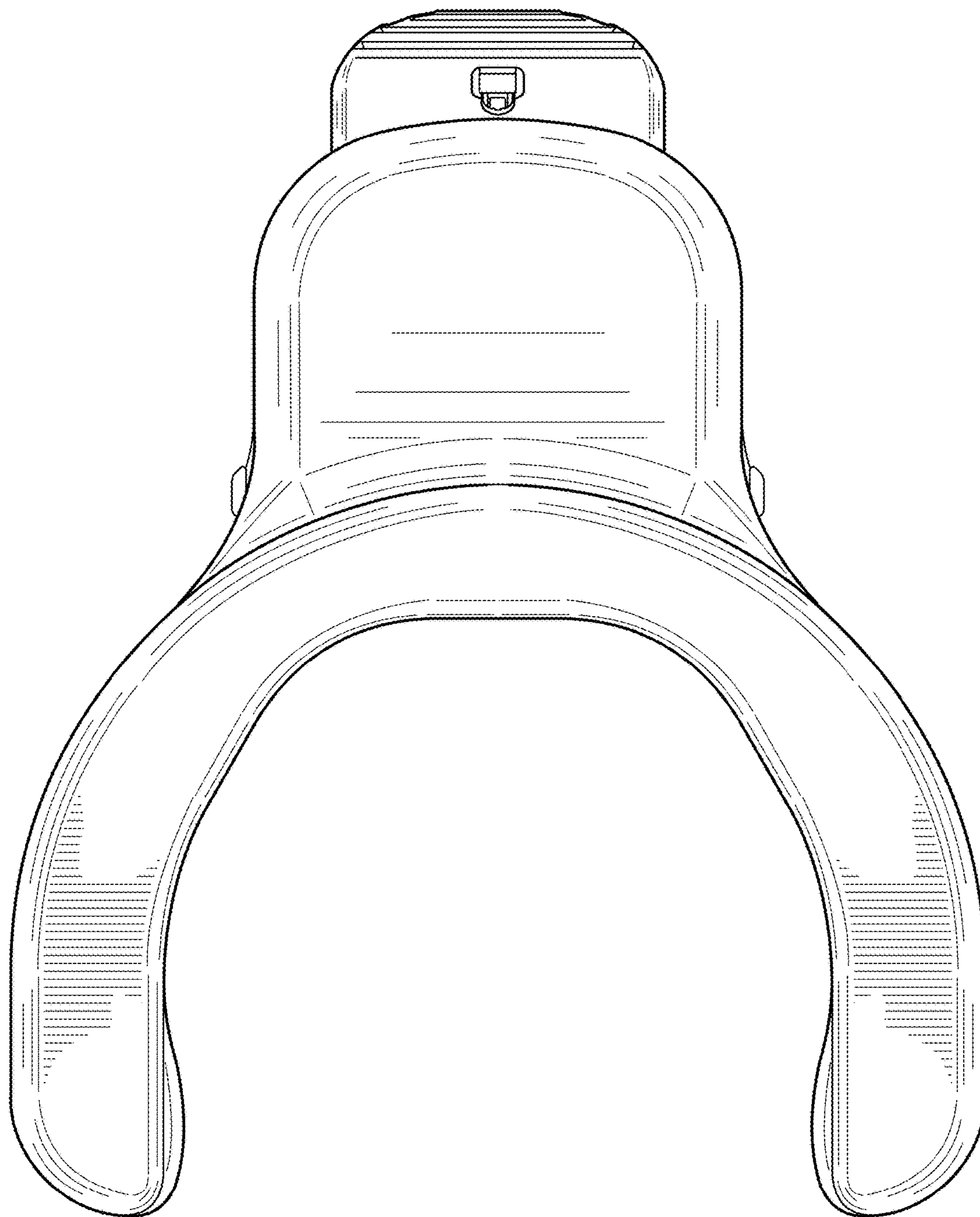

FIG. 5

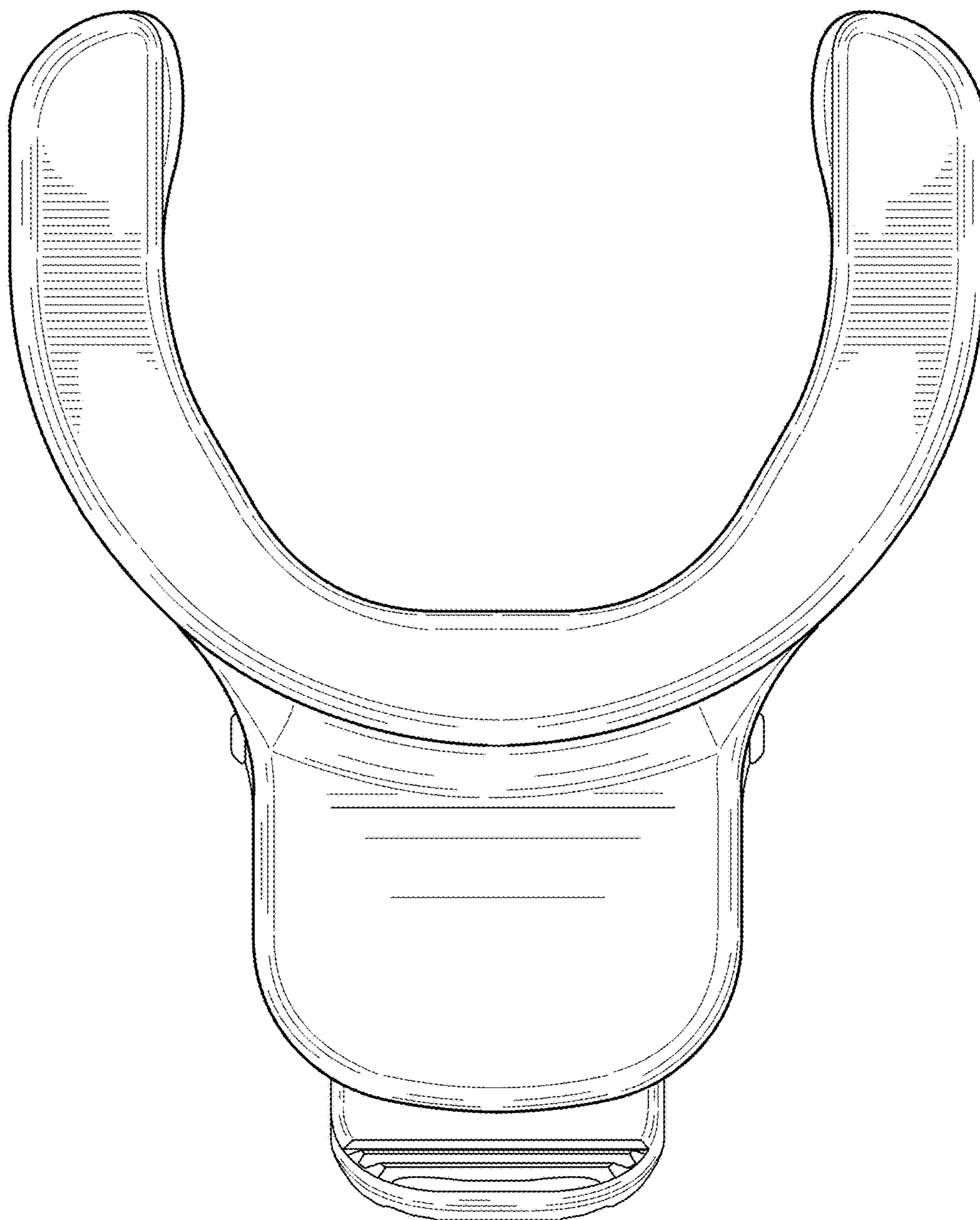
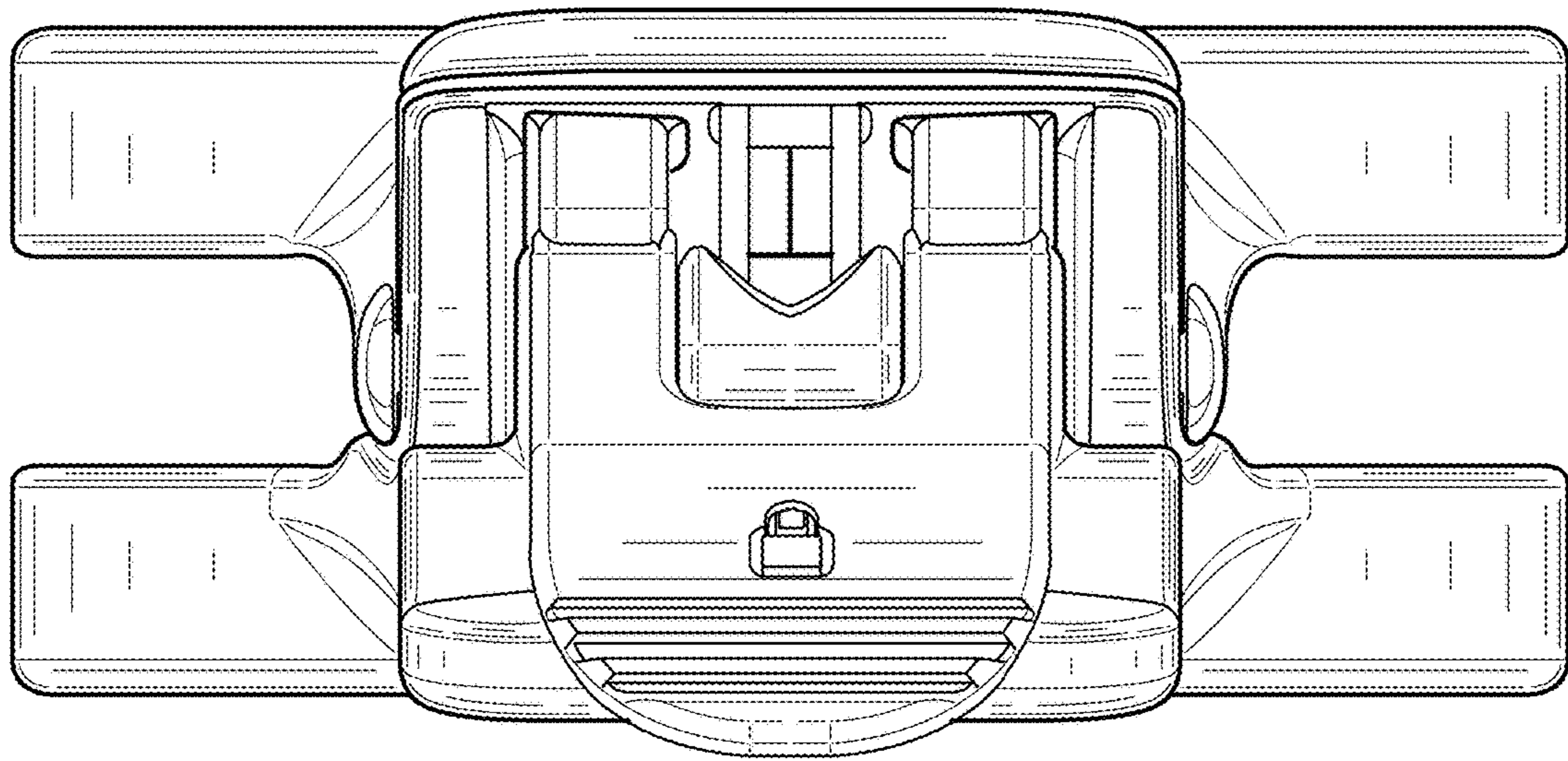

FIG. 6



**FIG. 7**



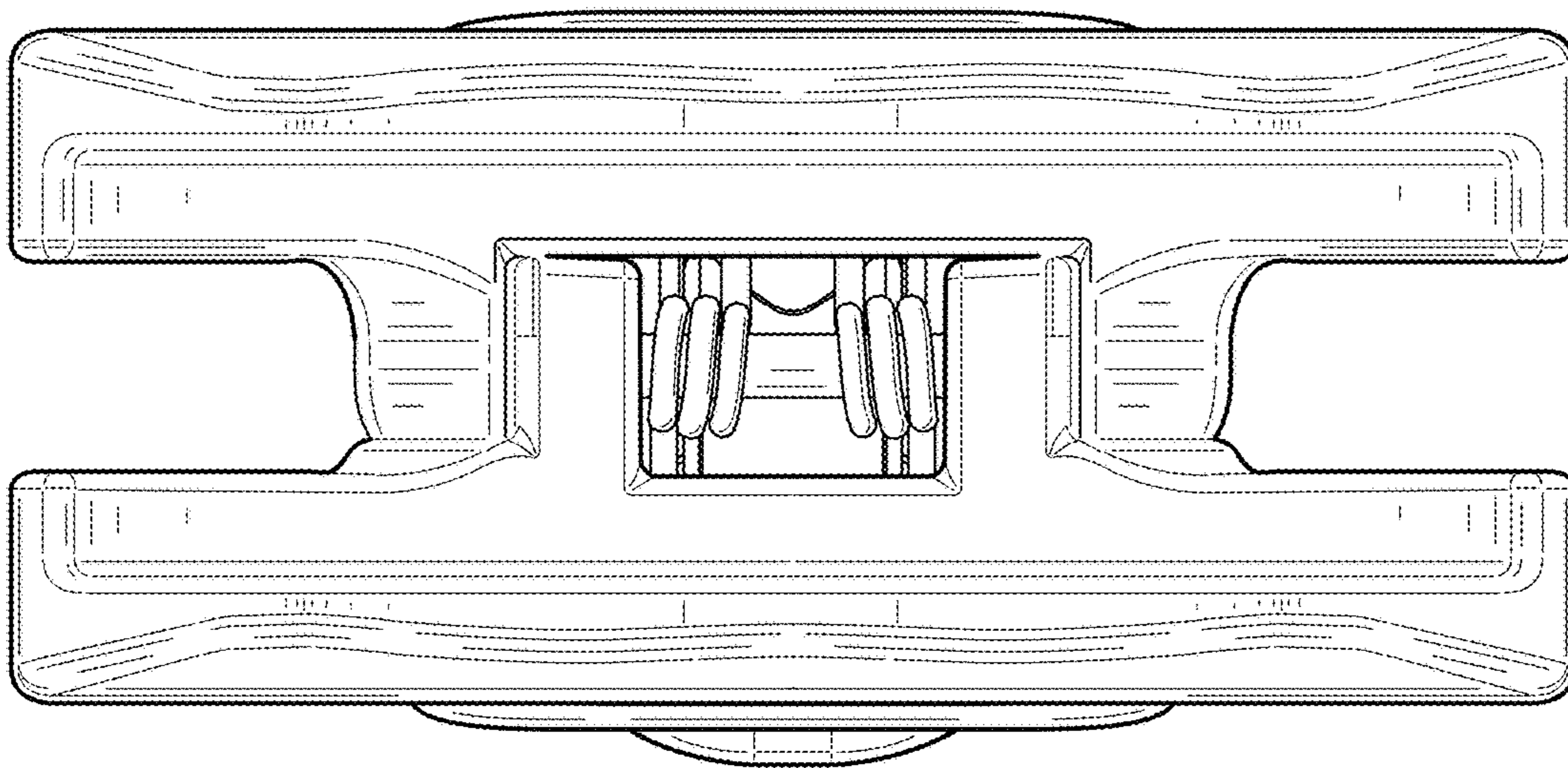

FIG. 8