



US00D792851S

(12) **United States Design Patent** (10) **Patent No.:** **US D792,851 S**
Li et al. (45) **Date of Patent:** **** Jul. 25, 2017**

(54) **CONNECTOR HOUSING**

(71) Applicant: **Molex, LLC**, Lisle, IL (US)

(72) Inventors: **Dixon Li**, Shanghai (CN); **Anson Yin**, Shanghai (CN)

(73) Assignee: **Molex, LLC**, Lisle, IL (US)

(**) Term: **15 Years**

(21) Appl. No.: **29/563,129**

(22) Filed: **May 2, 2016**

(51) **LOC (10) Cl.** **13-03**

(52) **U.S. Cl.**
USPC **D13/147**

(58) **Field of Classification Search**
USPC D13/133, 146, 147, 154, 155, 156, 184, D13/199

(Continued)

(56) **References Cited**

U.S. PATENT DOCUMENTS

D316,703 S * 5/1991 Eto D13/147
D463,370 S * 9/2002 Chen D13/147

(Continued)

FOREIGN PATENT DOCUMENTS

NO 2015/112975 A1 7/2015

Primary Examiner — Daniel Bui

(74) *Attorney, Agent, or Firm* — Banner & Witcoff, Ltd.

(57) **CLAIM**

The ornamental design for connector housing, as shown and described.

DESCRIPTION

FIG. 1 is a front perspective view of a connector housing showing a first embodiment of our new design;

FIG. 2 is a top view thereof;
FIG. 3 is a bottom view thereof;
FIG. 4 is a right side view thereof;
FIG. 5 is a left side view thereof;
FIG. 6 is a front view thereof;
FIG. 7 is a rear view thereof;
FIG. 8 is a front perspective view of a connector housing showing a second embodiment of our new design;
FIG. 9 is a top view thereof;
FIG. 10 is a bottom view thereof;
FIG. 11 is a right side view thereof;
FIG. 12 is a left side view thereof;
FIG. 13 is a front view thereof;
FIG. 14 is a rear view thereof;
FIG. 15 is a front perspective view of a connector housing showing a third embodiment of our new design;
FIG. 16 is a top view thereof;
FIG. 17 is a bottom view thereof;
FIG. 18 is a right side view thereof;
FIG. 19 is a left side view thereof;
FIG. 20 is a front view thereof;
FIG. 21 is a rear view thereof;
FIG. 22 is a front perspective view of a connector housing showing a fourth embodiment of our new design;
FIG. 23 is a top view thereof;
FIG. 24 is a bottom view thereof;
FIG. 25 is a right side view thereof;
FIG. 26 is a left side view thereof;
FIG. 27 is a front view thereof;
FIG. 28 is a rear view thereof;
FIG. 29 is a front perspective view of a connector housing showing a fifth embodiment of our new design;
FIG. 30 is a top view thereof;
FIG. 31 is a bottom view thereof;
FIG. 32 is a right side view thereof;
FIG. 33 is a left side view thereof;
FIG. 34 is a front view thereof;
FIG. 35 is a rear view thereof;
FIG. 36 is a front perspective view of a connector housing showing a sixth embodiment of our new design;
FIG. 37 is a top view thereof;
FIG. 38 is a bottom view thereof;
FIG. 39 is a right side view thereof;
FIG. 40 is a left side view thereof;

(Continued)

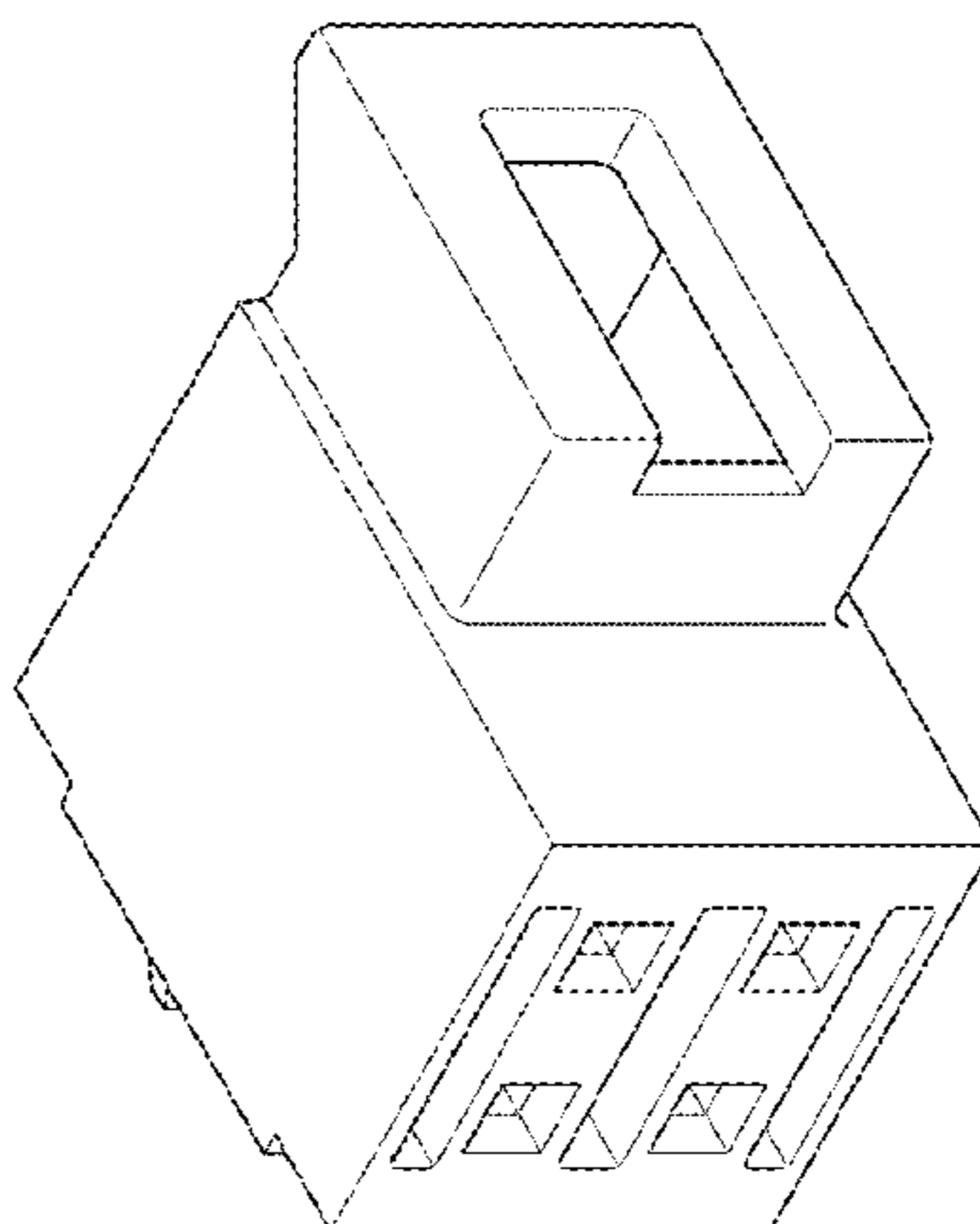

FIG. 41 is a front view thereof;
FIG. 42 is a rear view thereof;
FIG. 43 is a front perspective view of a connector housing showing a seventh embodiment of our new design;
FIG. 44 is a top view thereof;
FIG. 45 is a bottom view thereof;
FIG. 46 is a right side view thereof;
FIG. 47 is a left side view thereof;
FIG. 48 is a front view thereof; and,
FIG. 49 is a rear view thereof.
The connector housing in each embodiment is symmetrical about its longitudinal center plane.

1 Claim, 49 Drawing Sheets

(58) **Field of Classification Search**
CPC H01R 13/02; H01R 13/436; H01R 13/502;

H01R 13/504; H01R 13/506; H01R 13/514; H01R 13/5208; H01R 13/627; H01R 13/639; H01R 13/6581; H01R 24/20; H01R 24/28

See application file for complete search history.

(56)

References Cited

U.S. PATENT DOCUMENTS

D479,199	S	*	9/2003	Jones	D13/147
D524,751	S	*	7/2006	Lee	D13/147
D531,960	S	*	11/2006	Kondas	D13/147
D583,770	S	*	12/2008	Ramsey	D13/146
D605,133	S	*	12/2009	Tanaka	D13/147
D719,098	S	*	12/2014	Endo	D13/147
D748,580	S	*	2/2016	Endo	D13/146
D748,588	S	*	2/2016	Endo	D13/147
D751,990	S	*	3/2016	Ikeda	D13/147

* cited by examiner

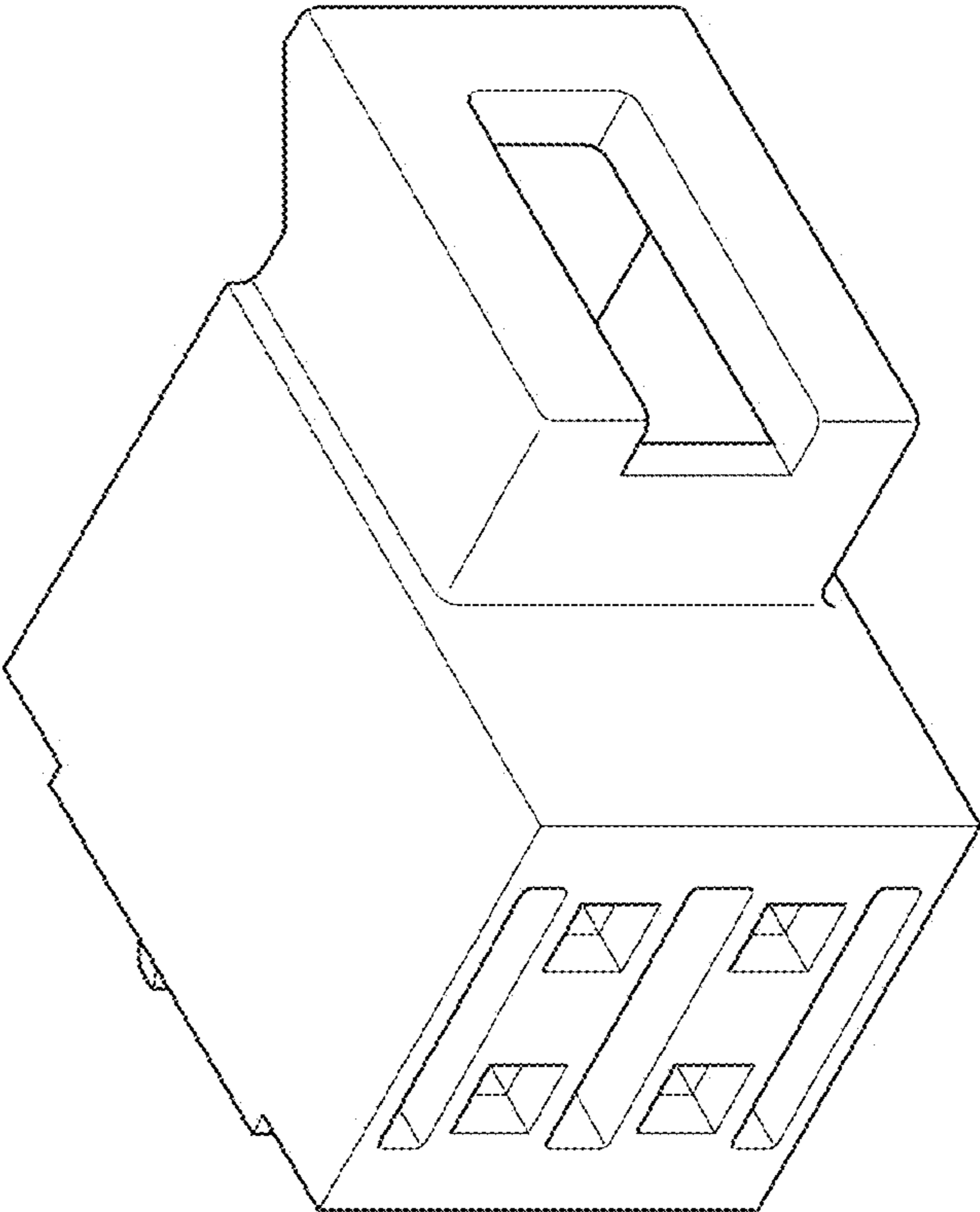

FIG. 1

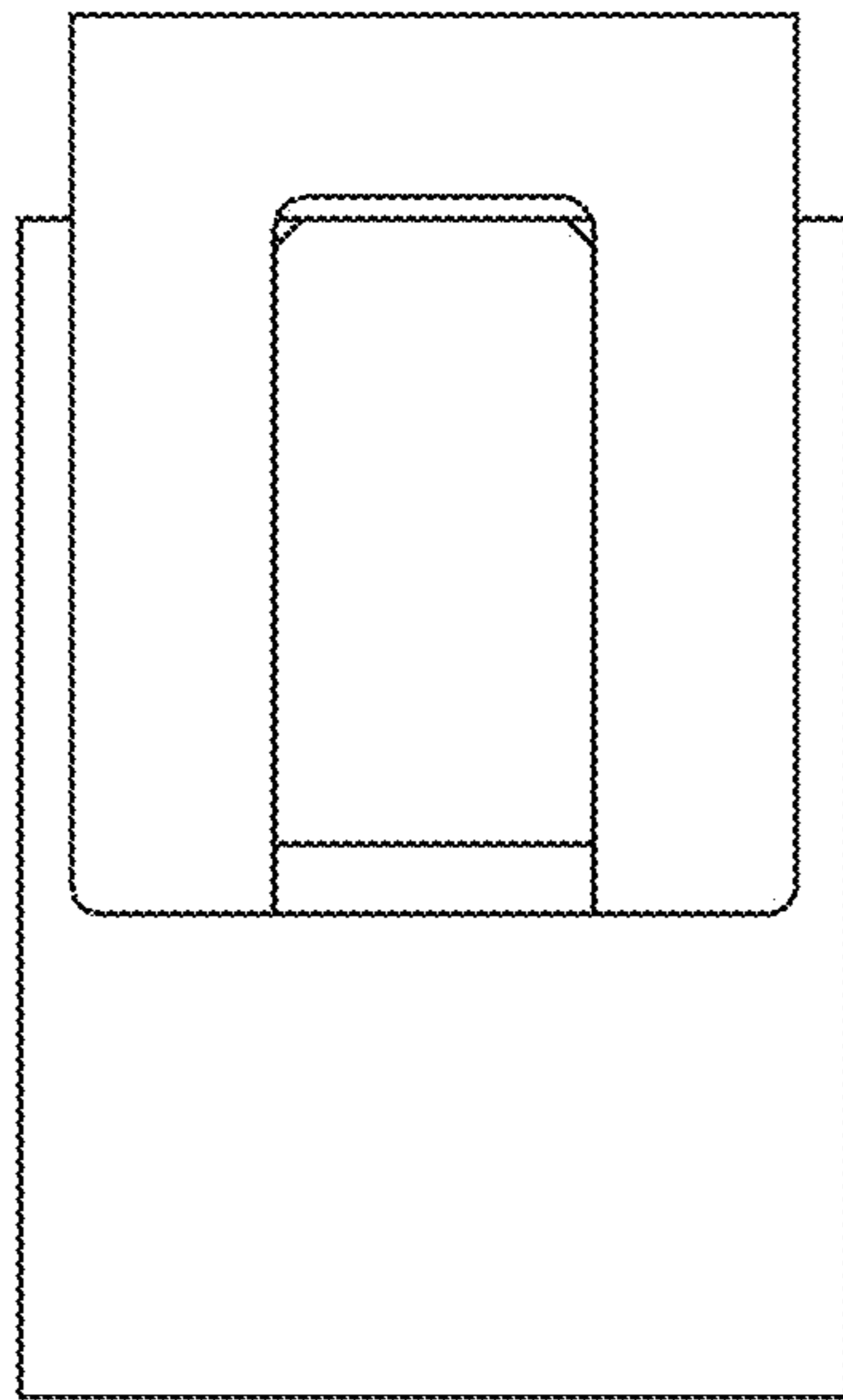

FIG. 2

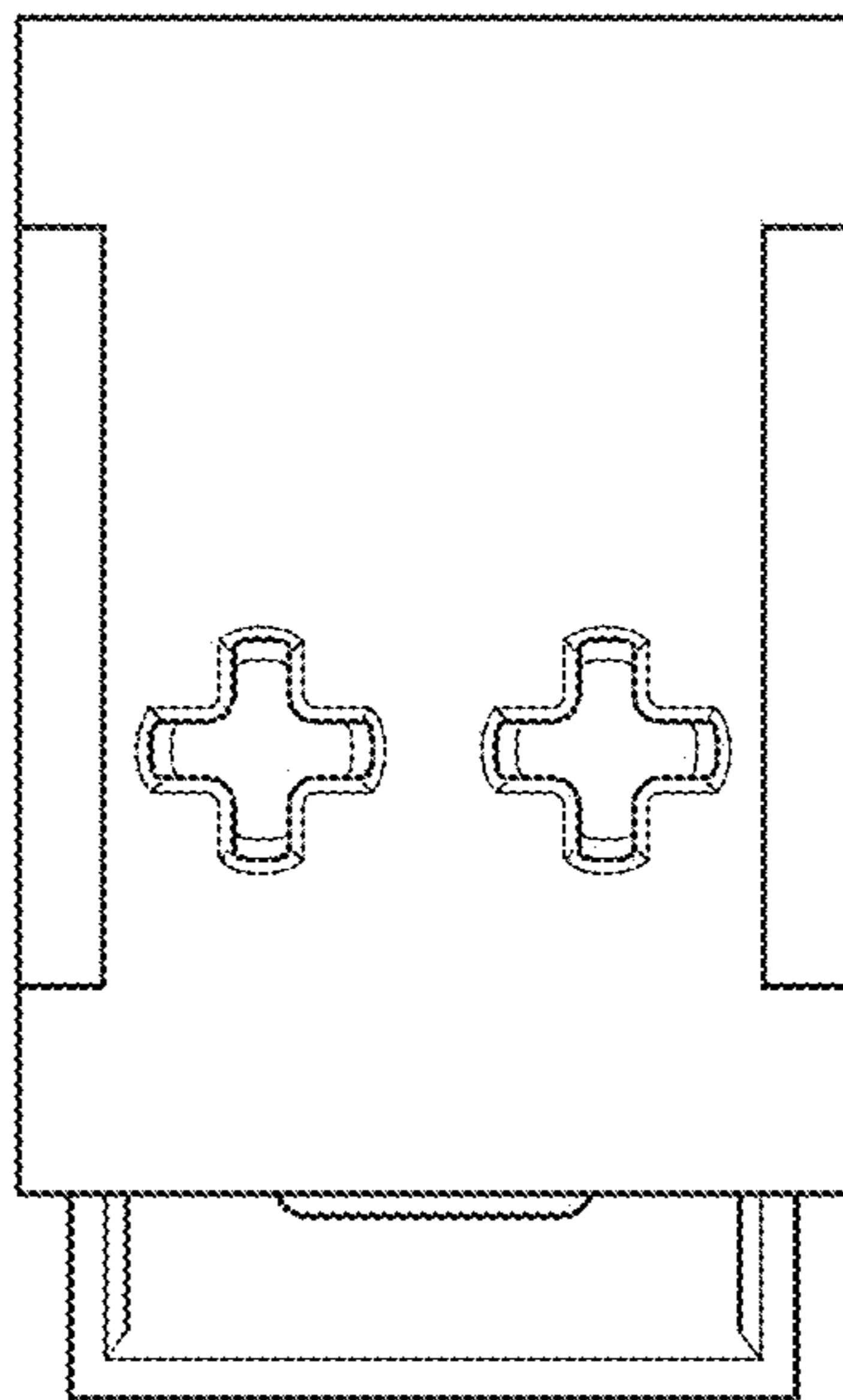

FIG. 3

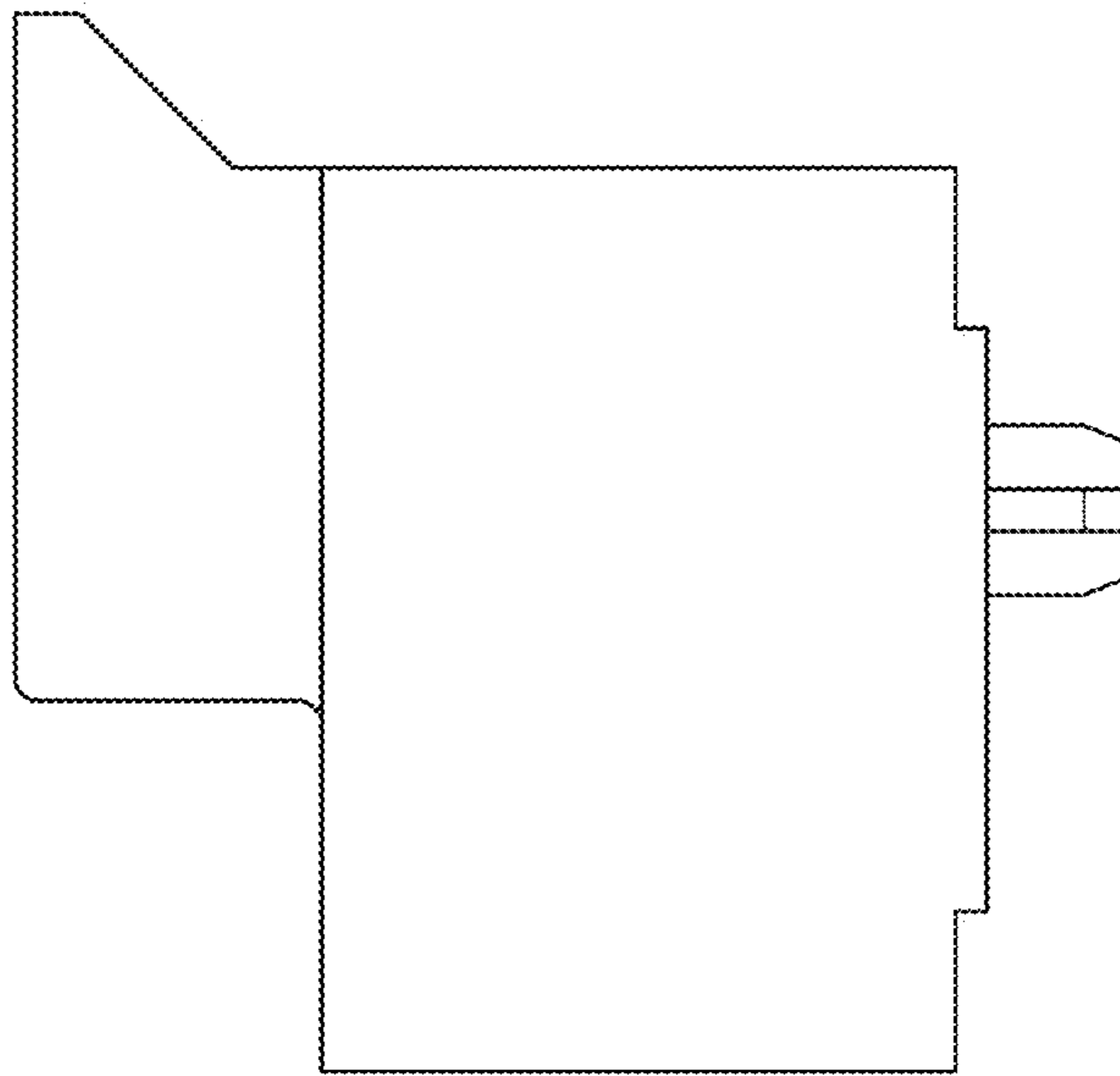

FIG. 4

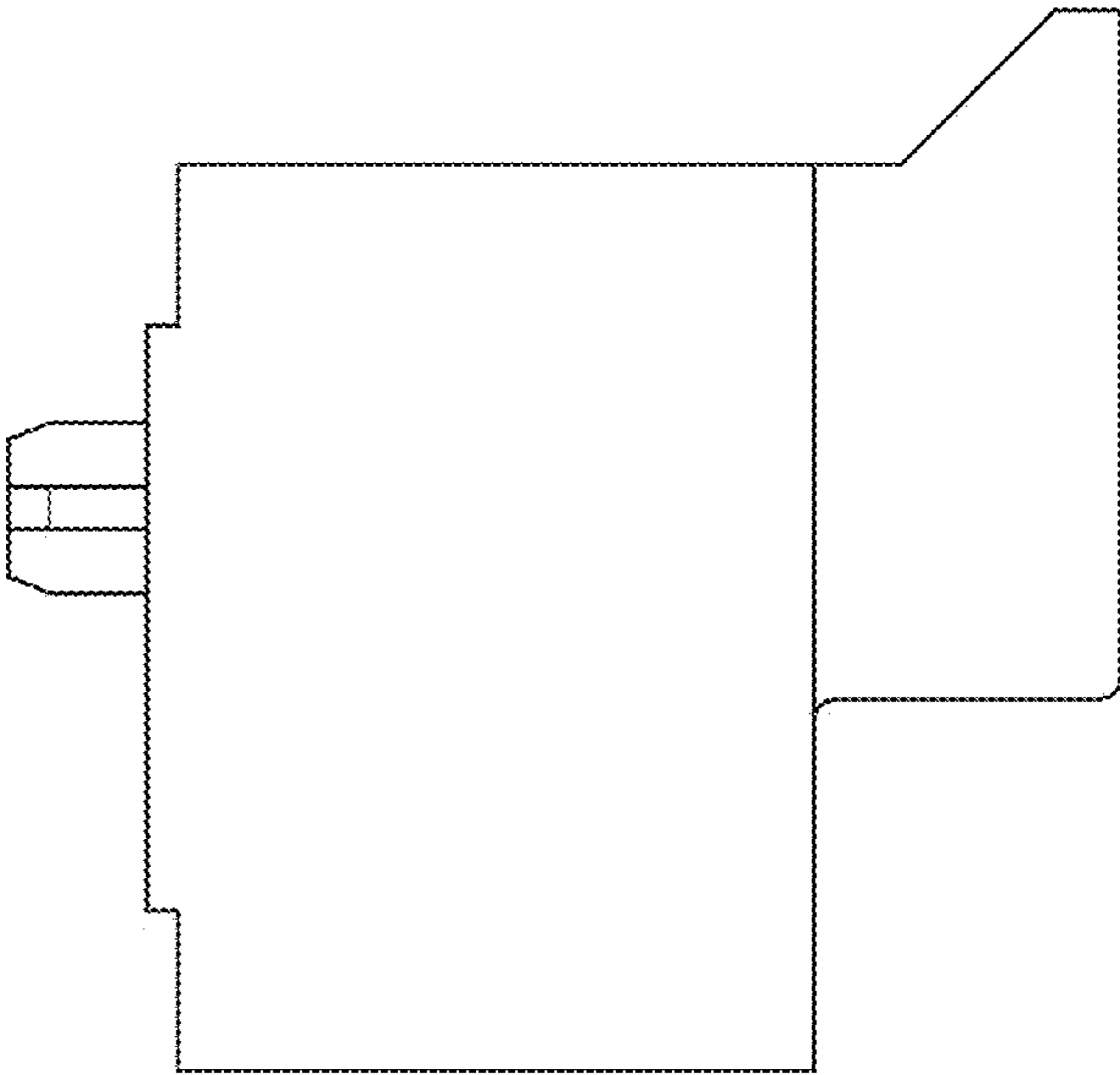

FIG. 5

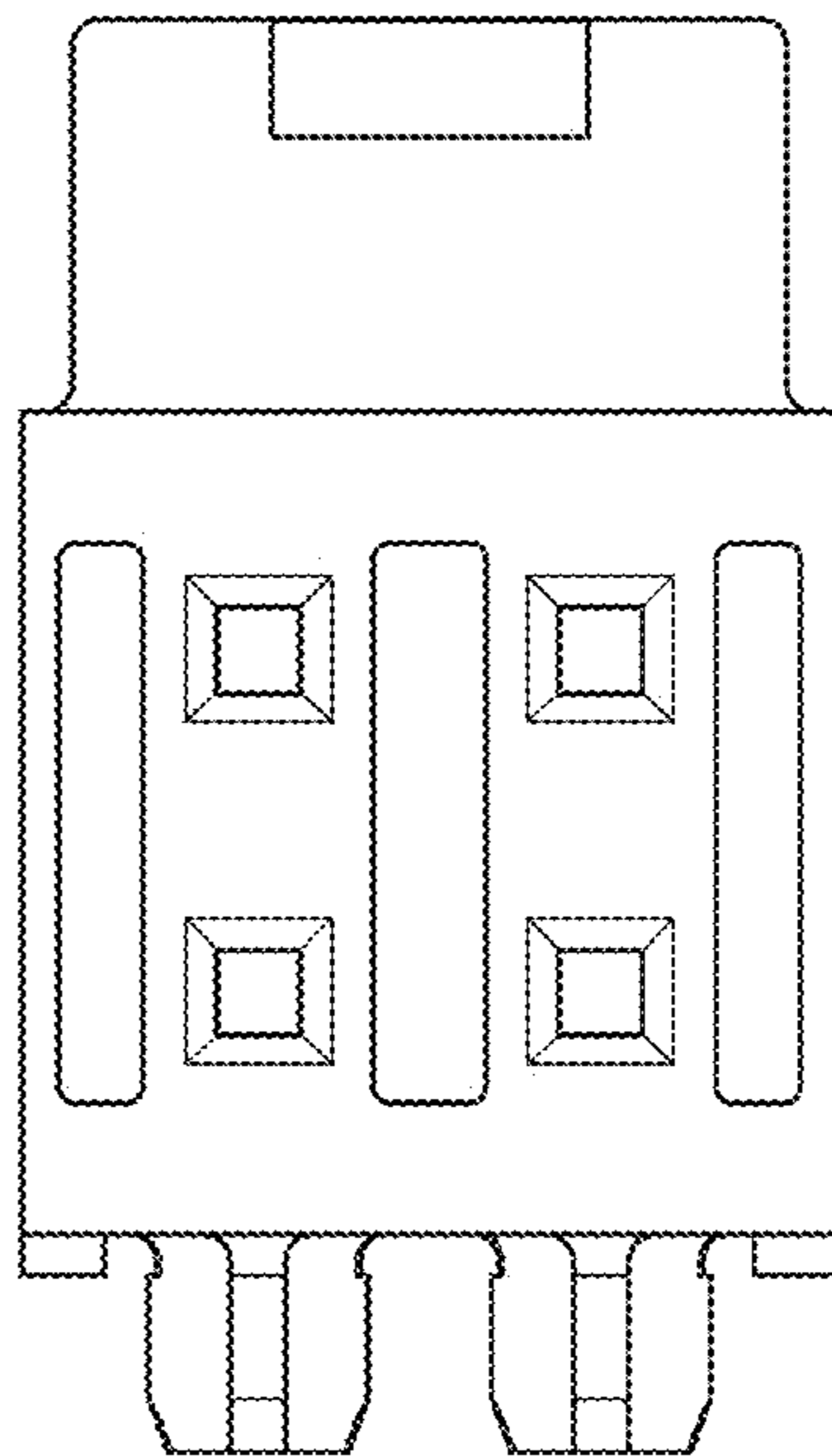

FIG. 6

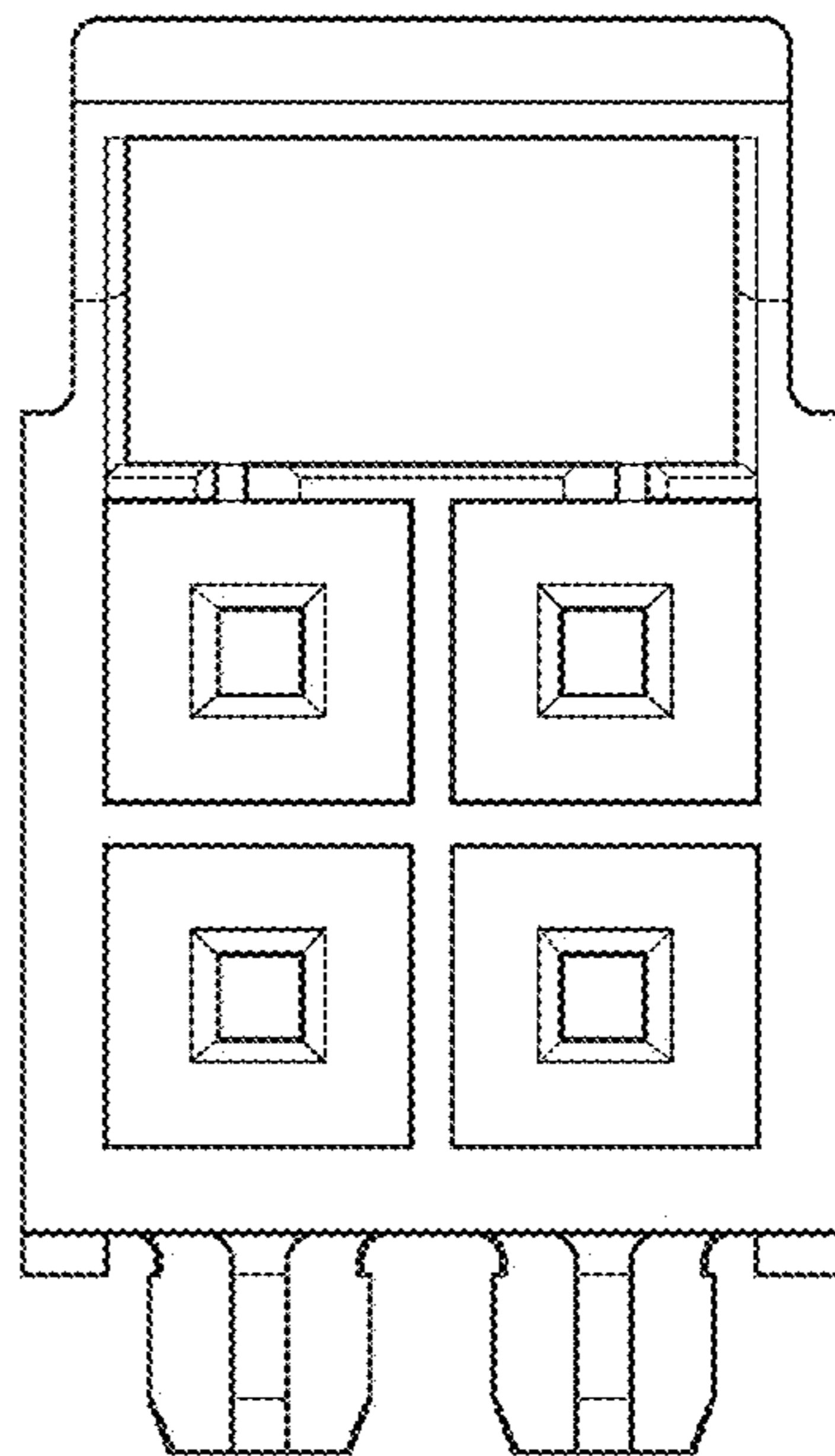

FIG. 7

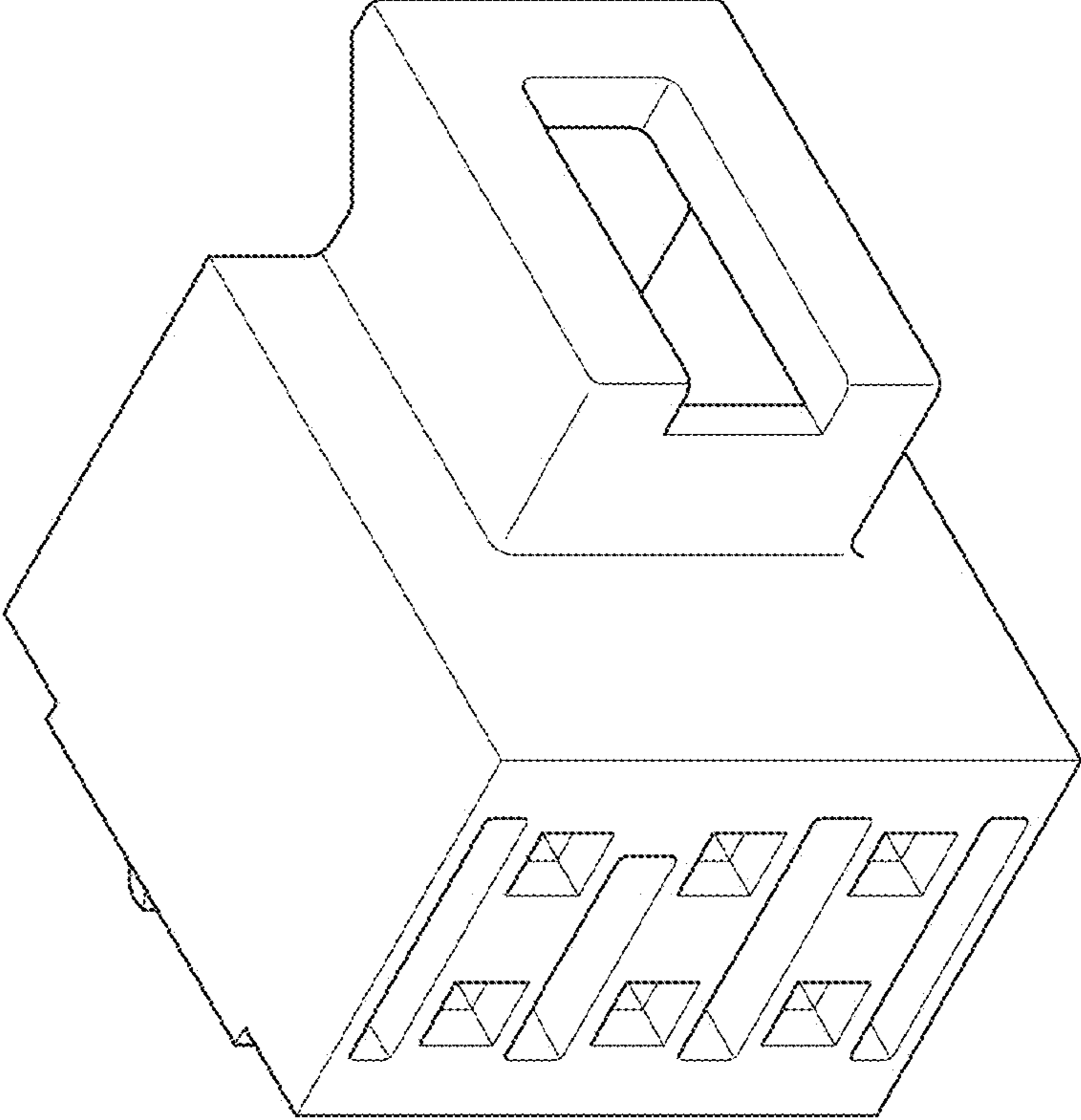

FIG. 8

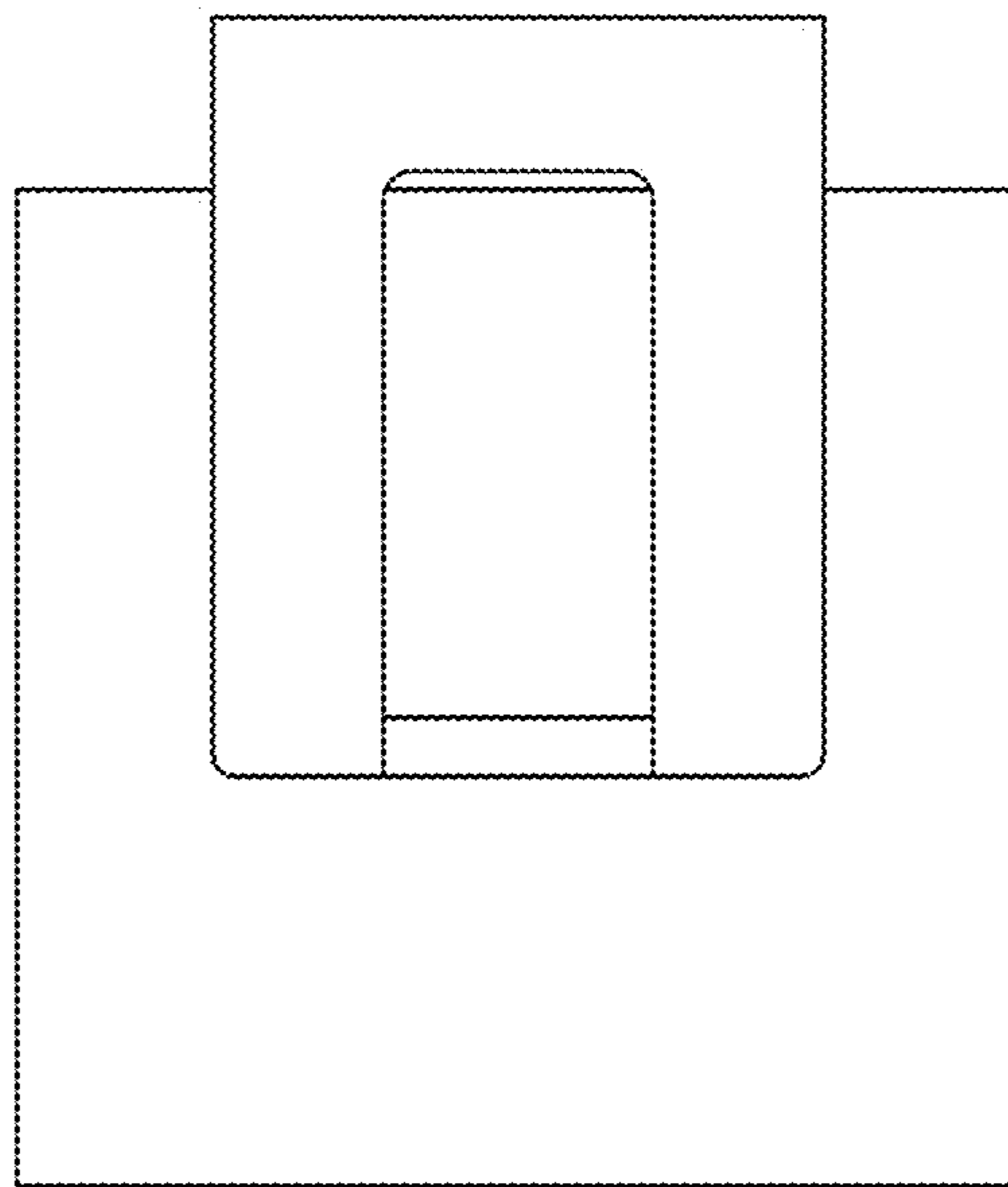

FIG. 9

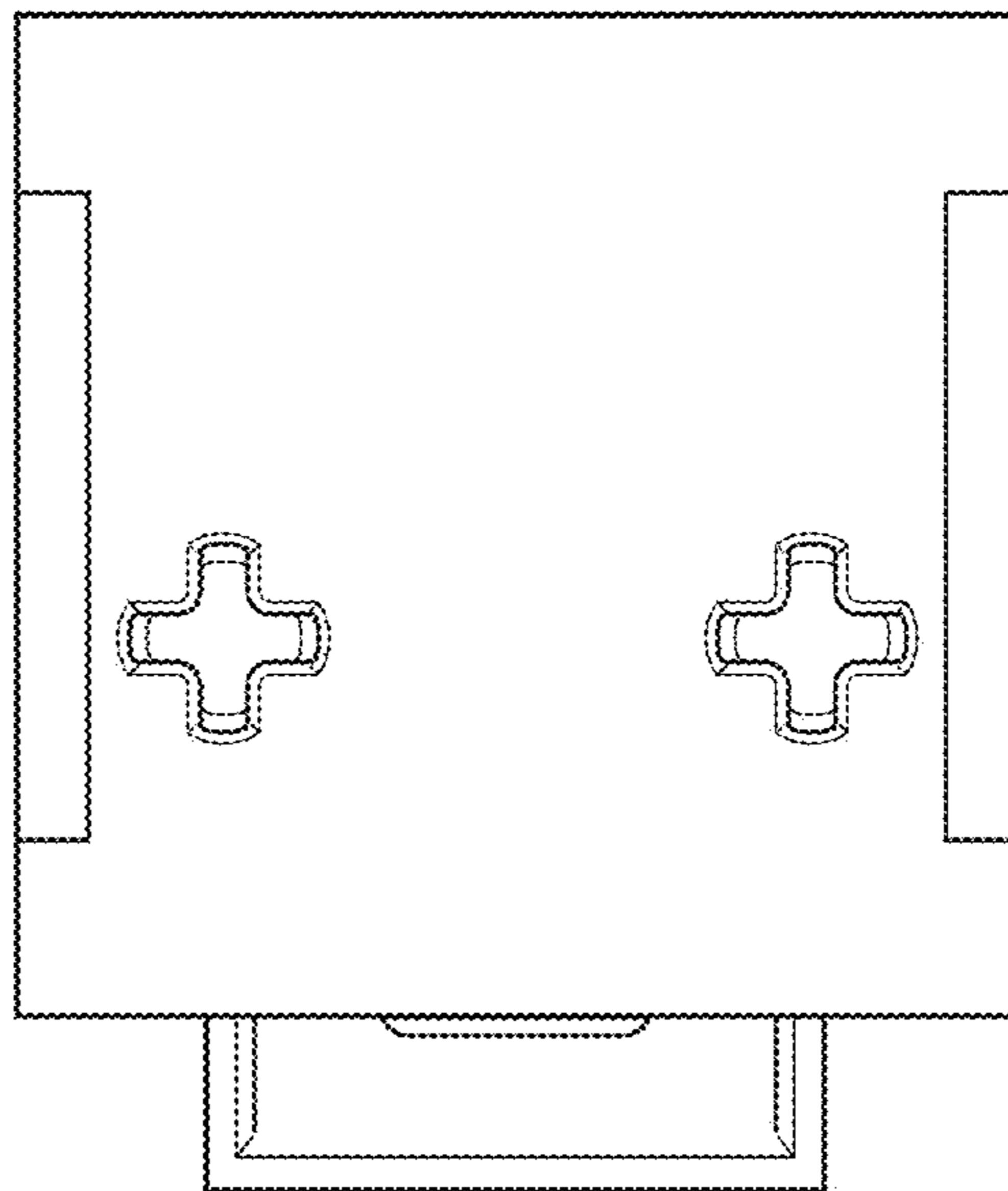

FIG. 10

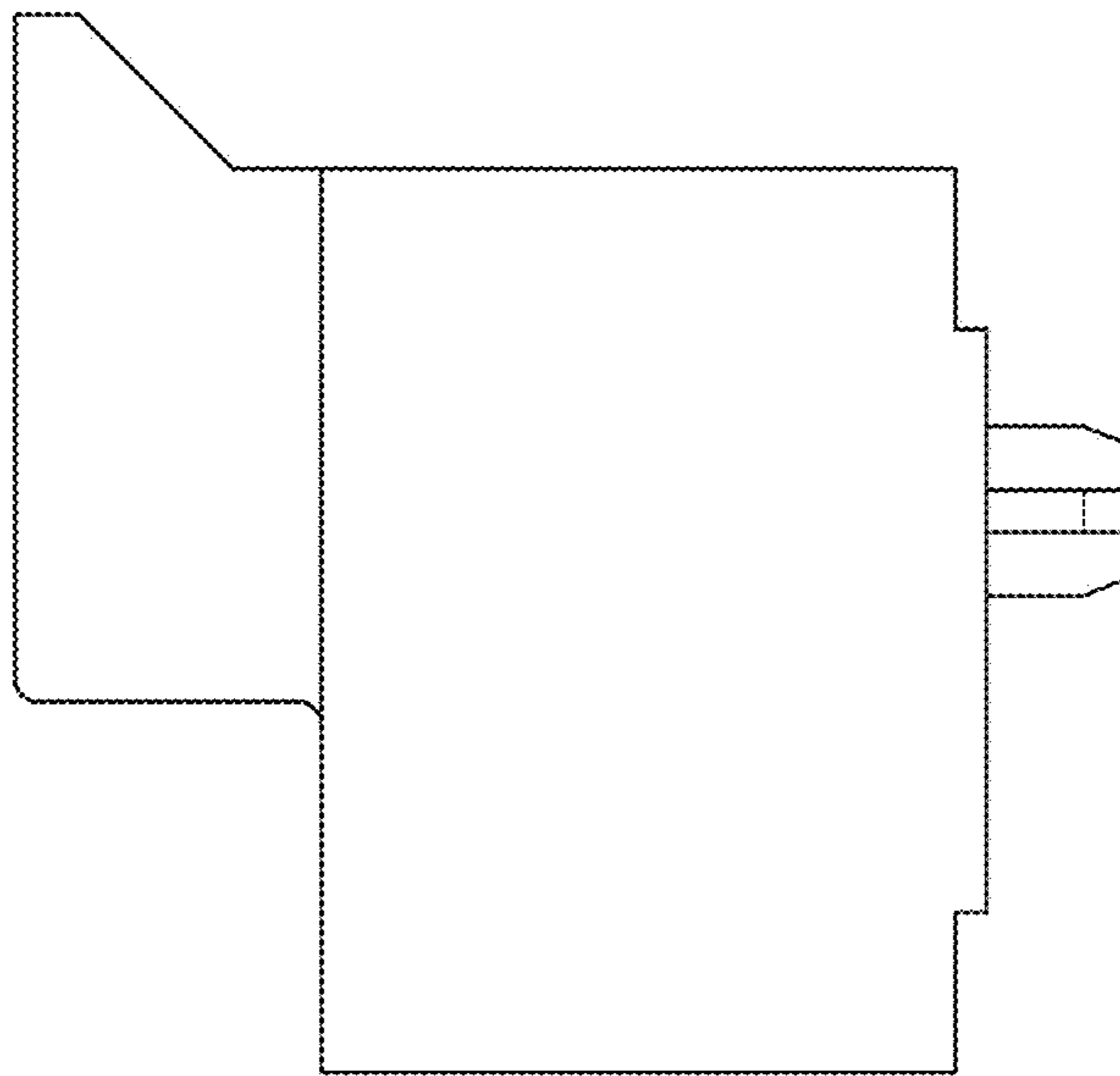

FIG. 11

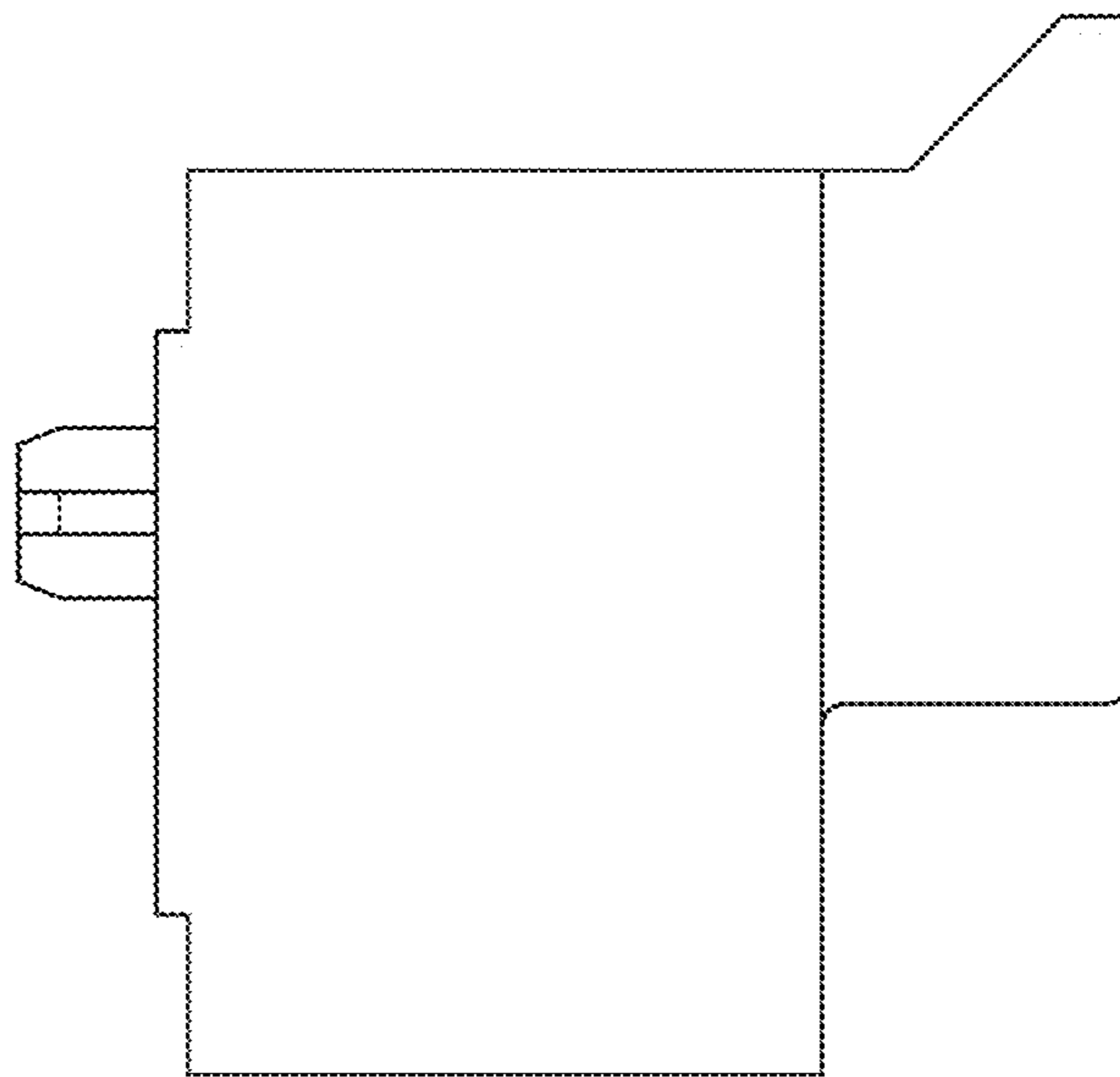

FIG. 12

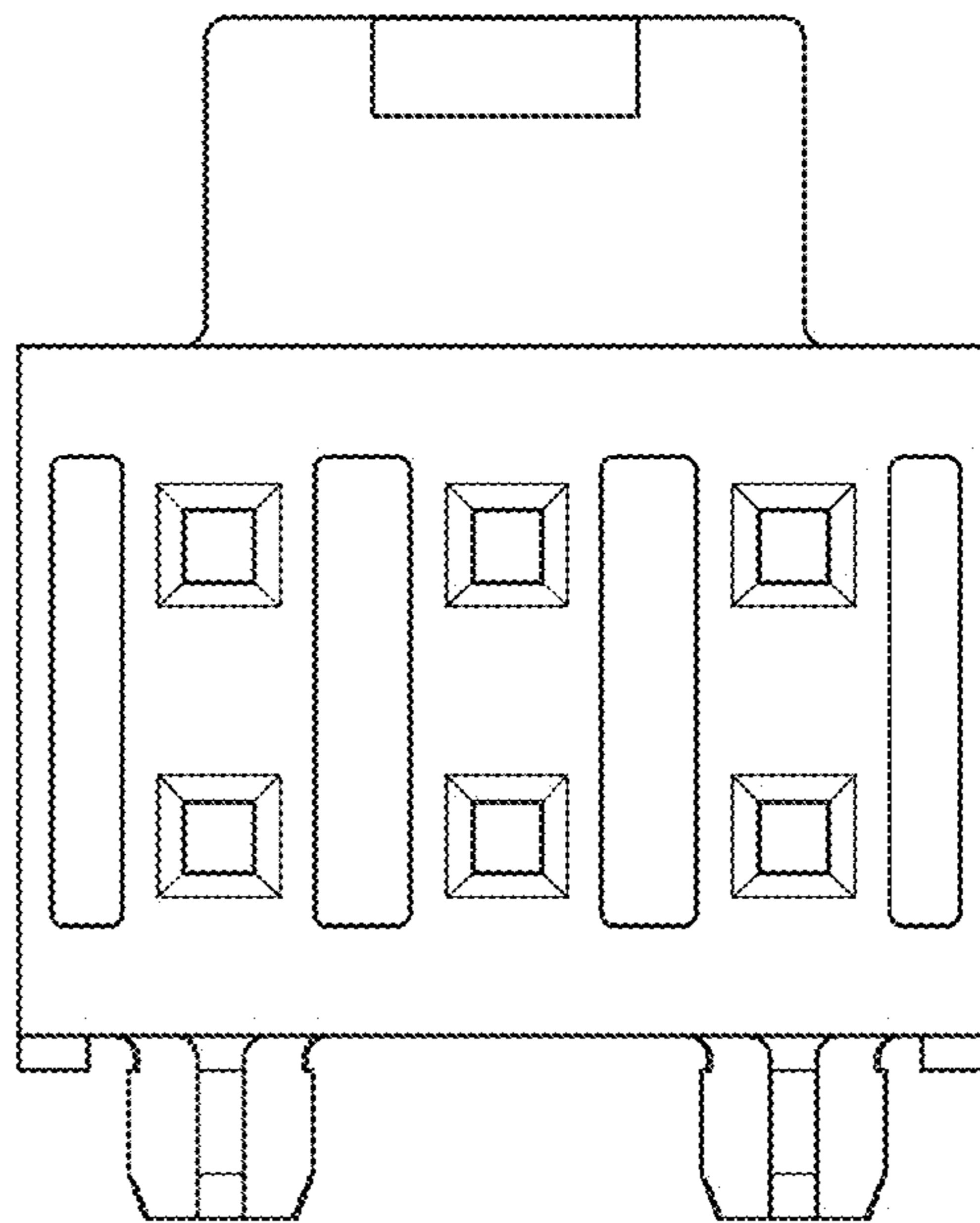

FIG. 13

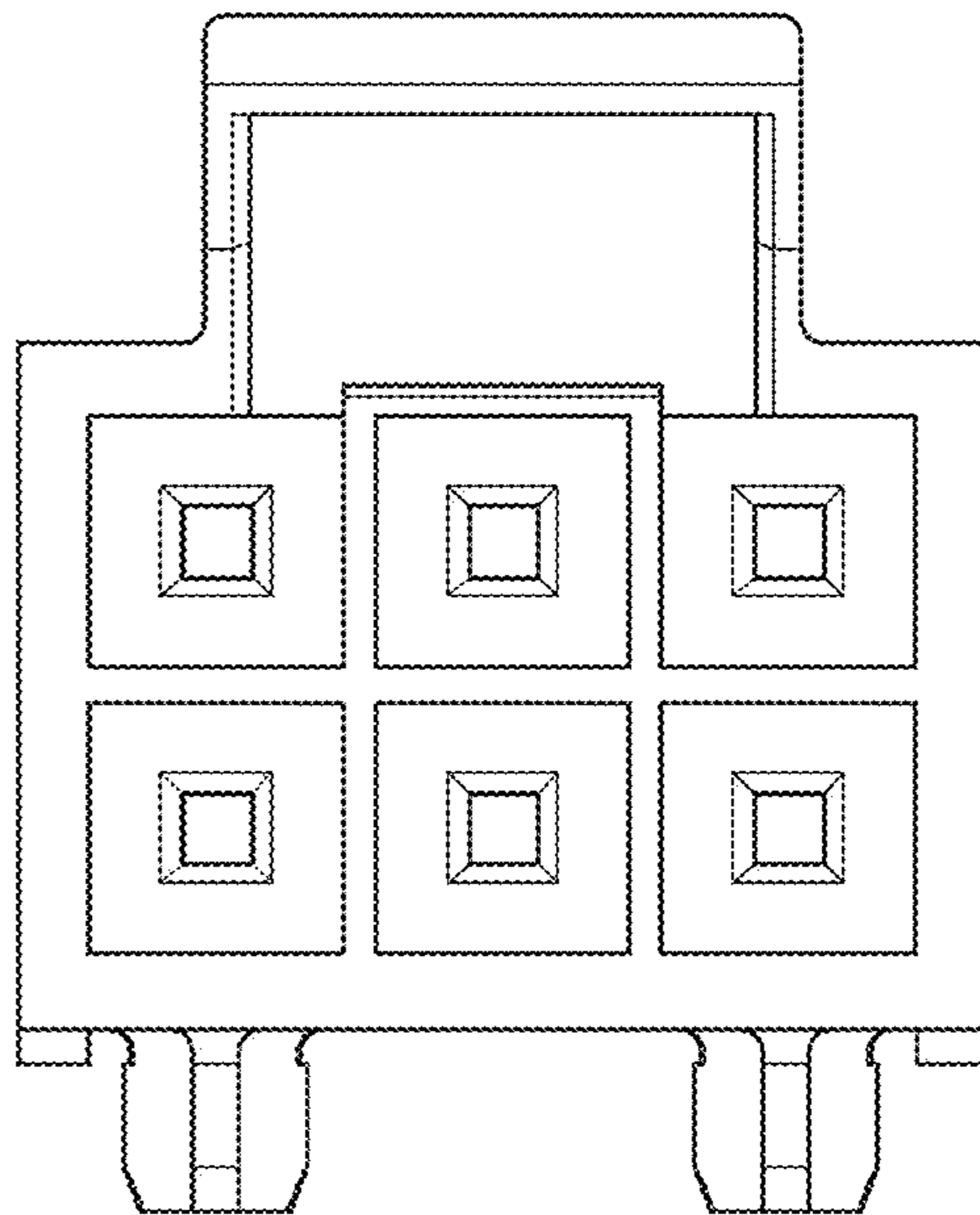

FIG. 14

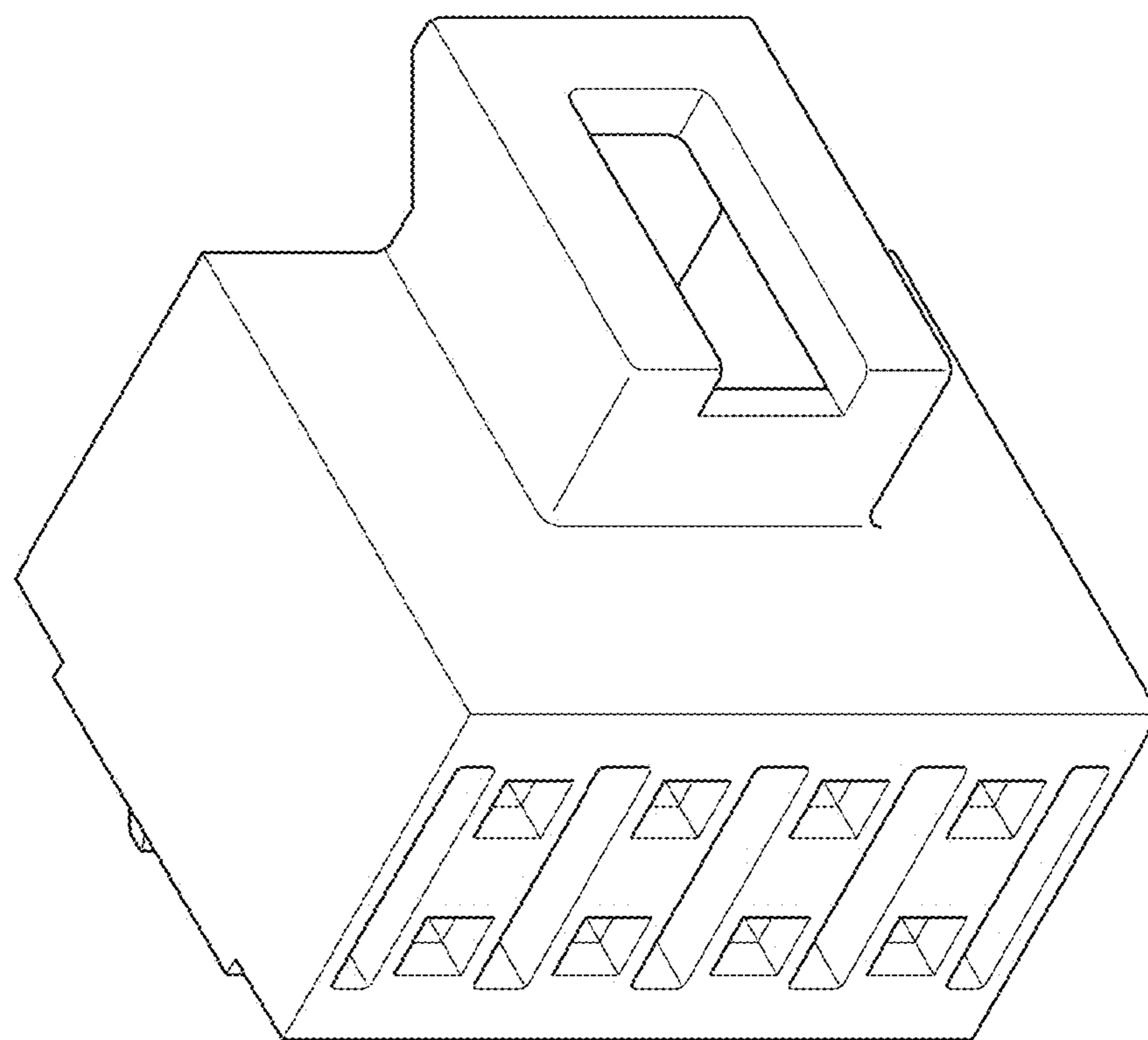

FIG. 15

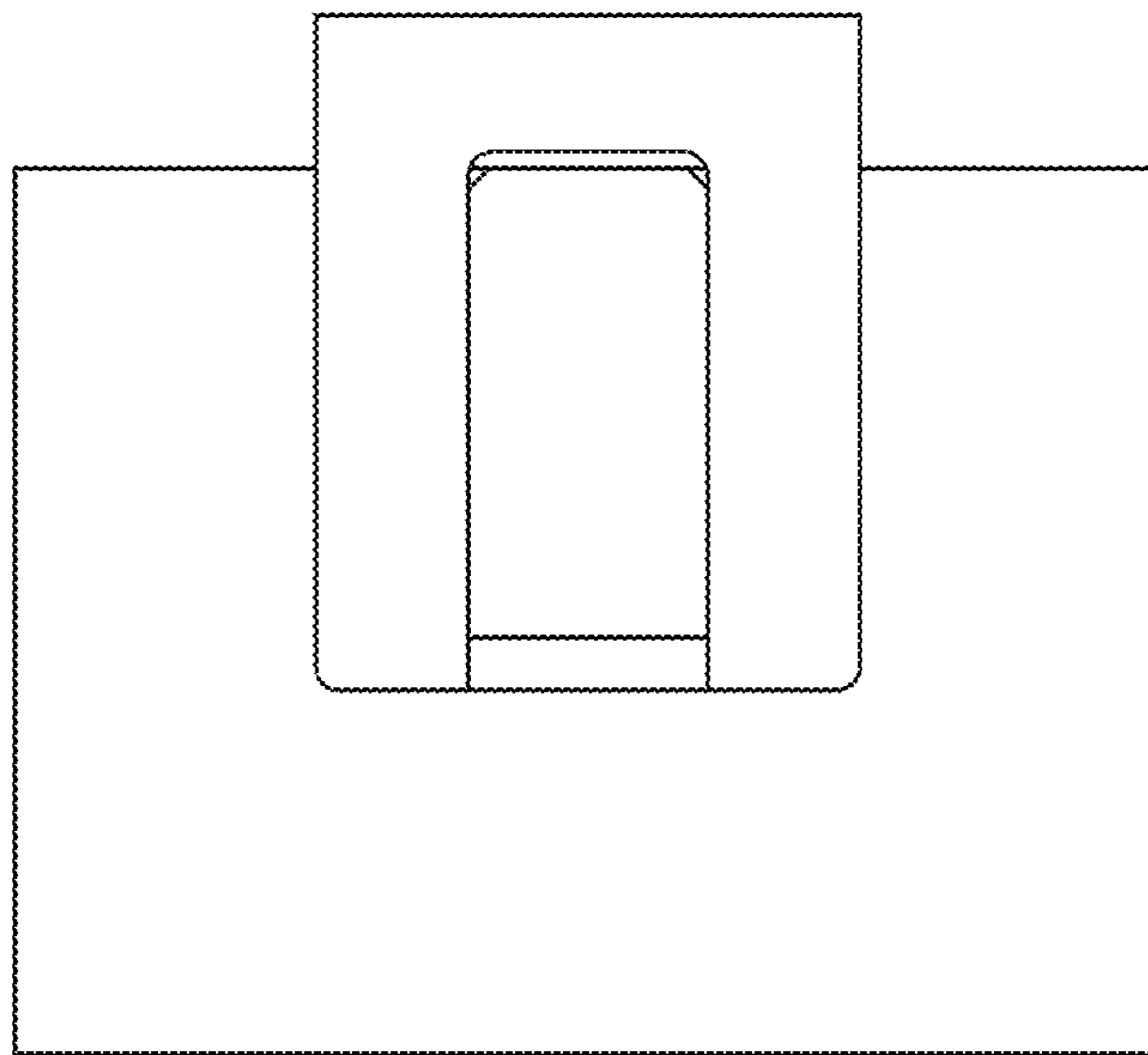

FIG. 16

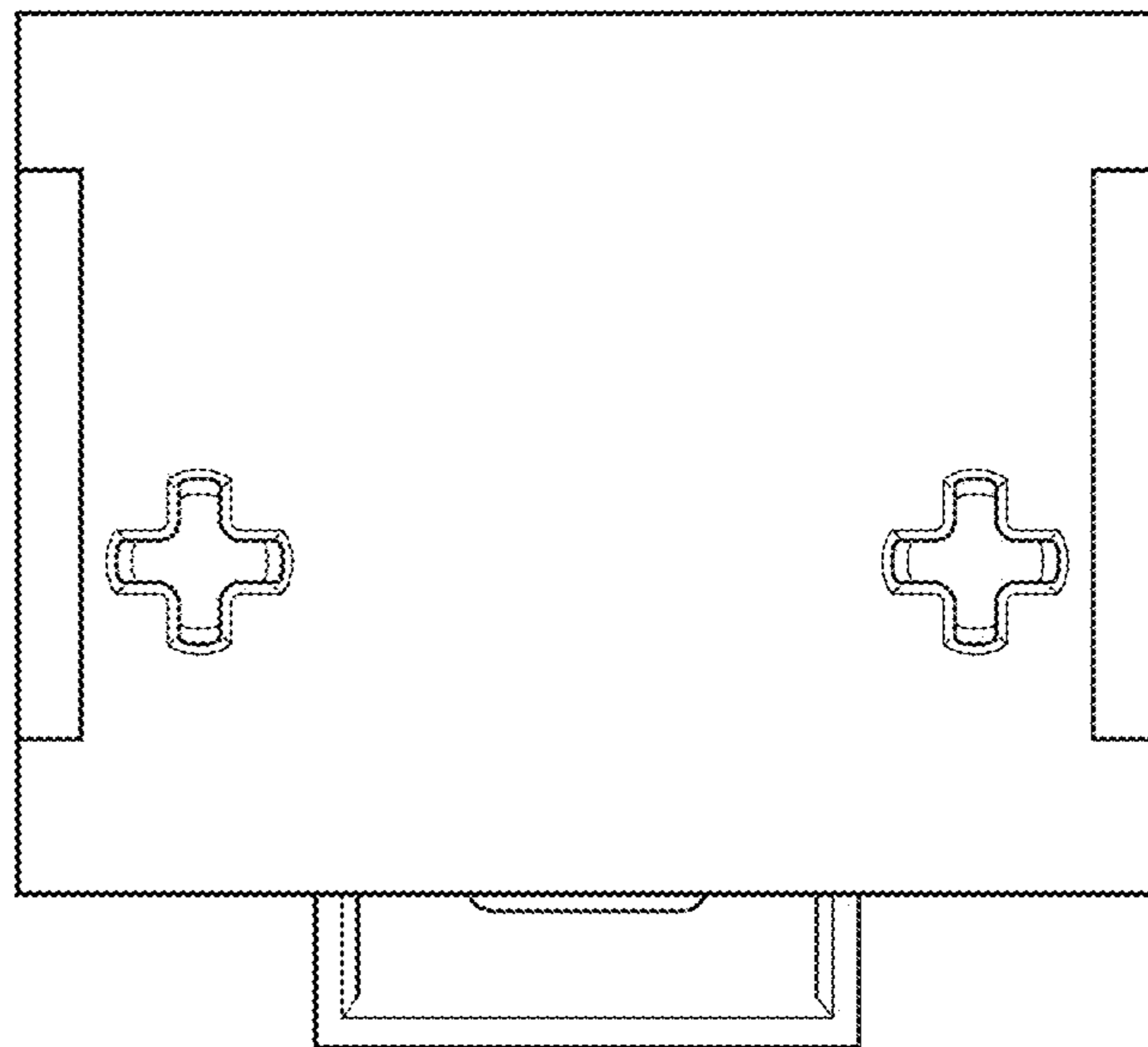

FIG. 17

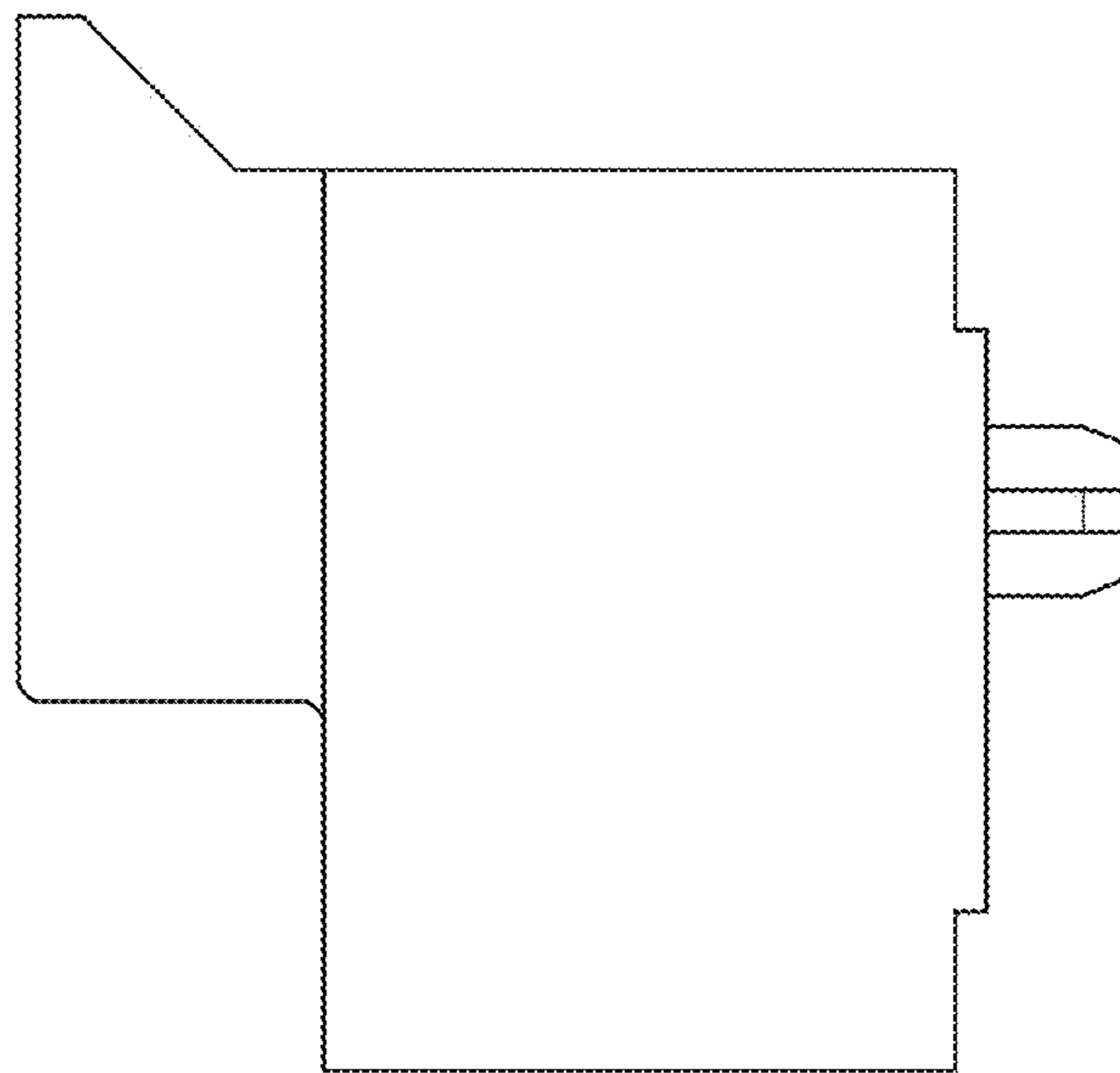

FIG. 18

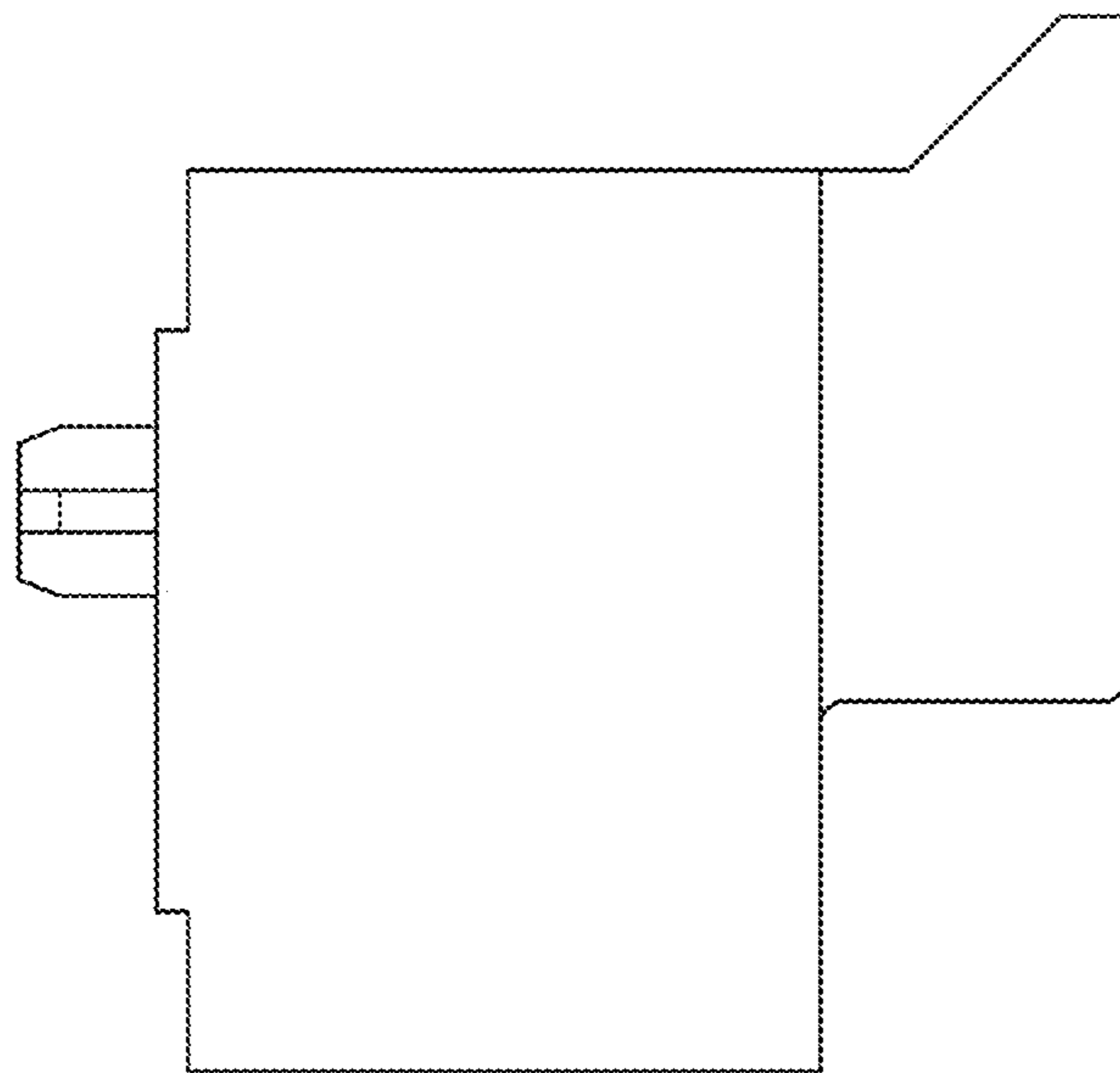

FIG. 19

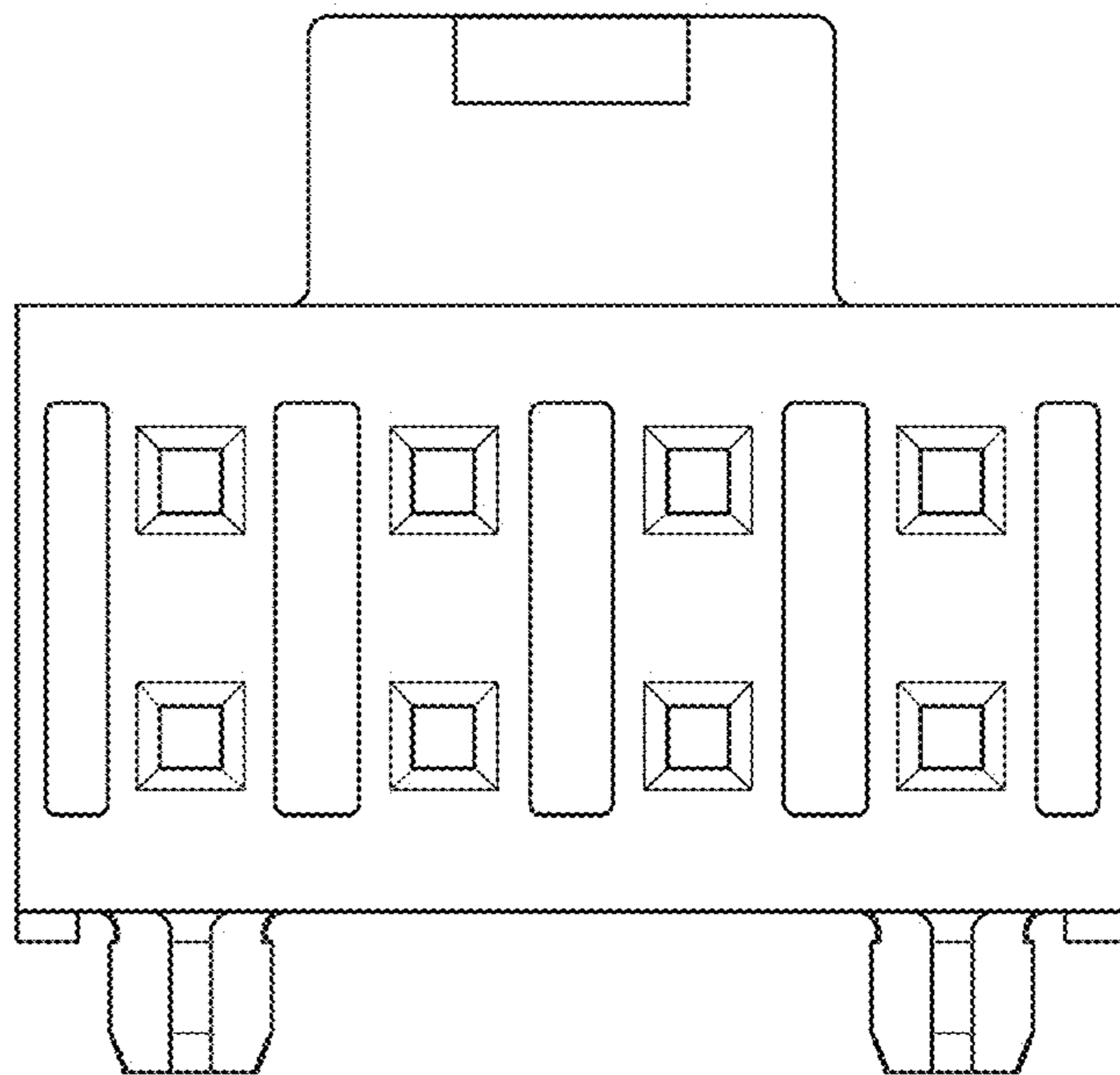

FIG. 20

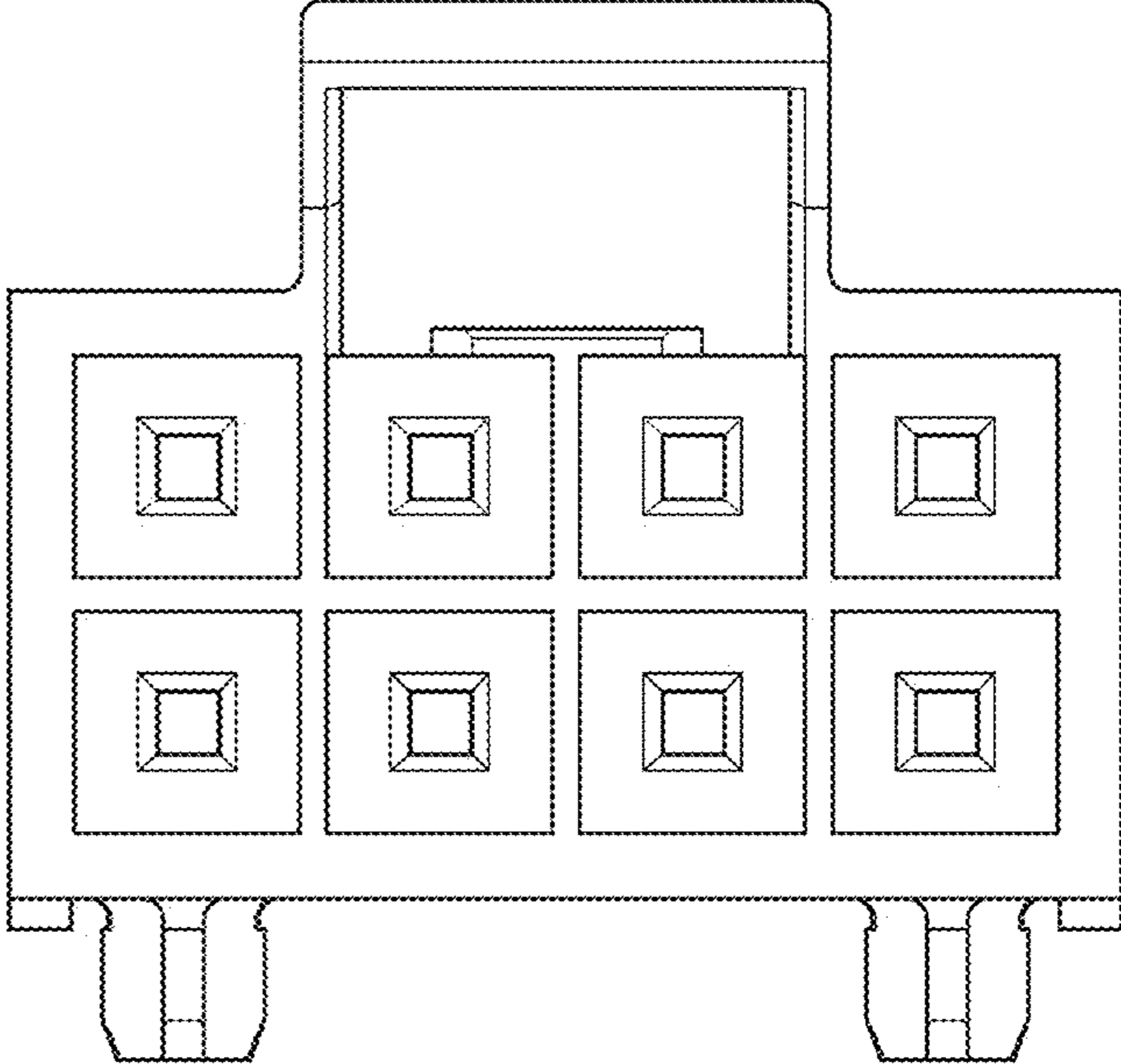

FIG. 21

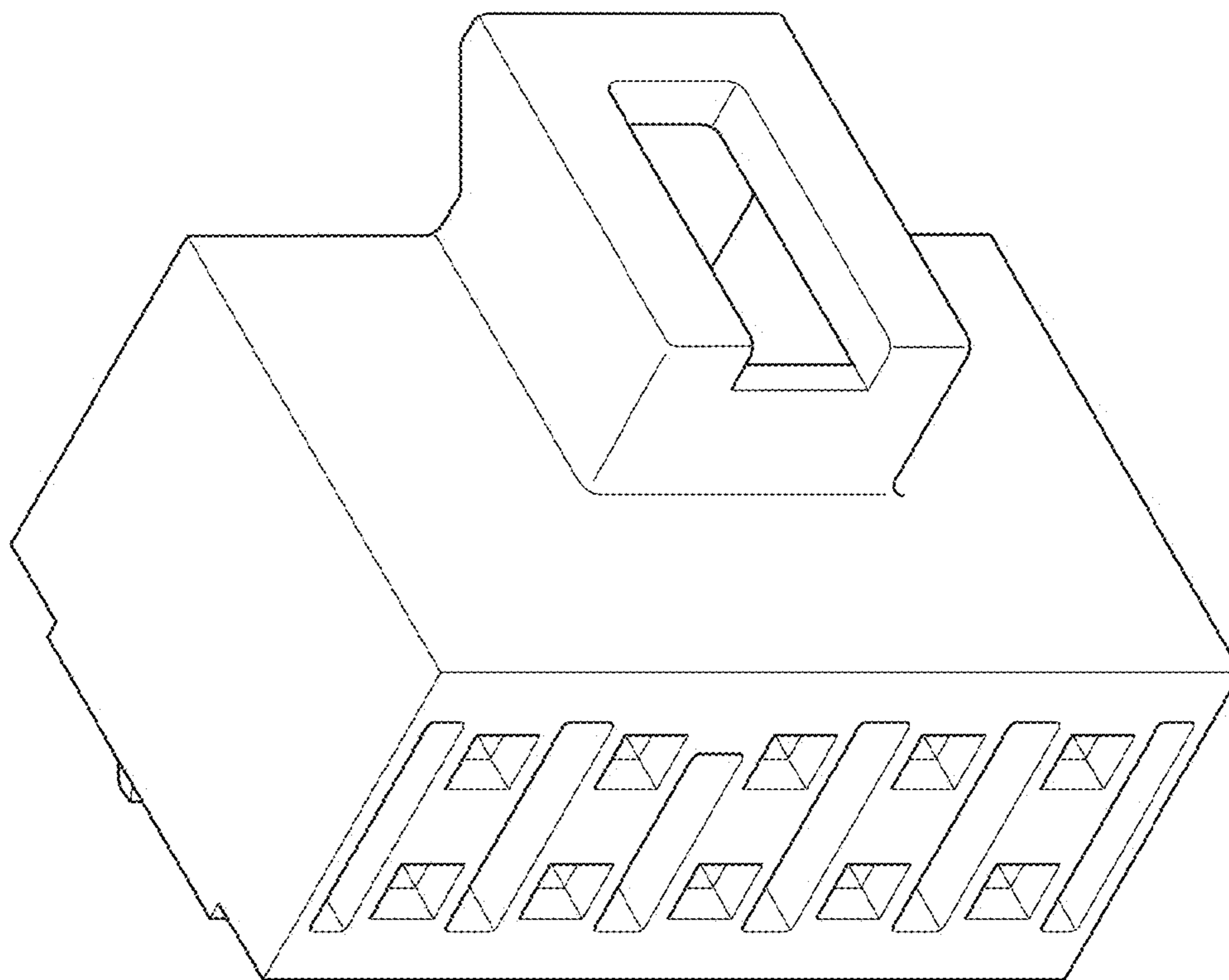

FIG. 22

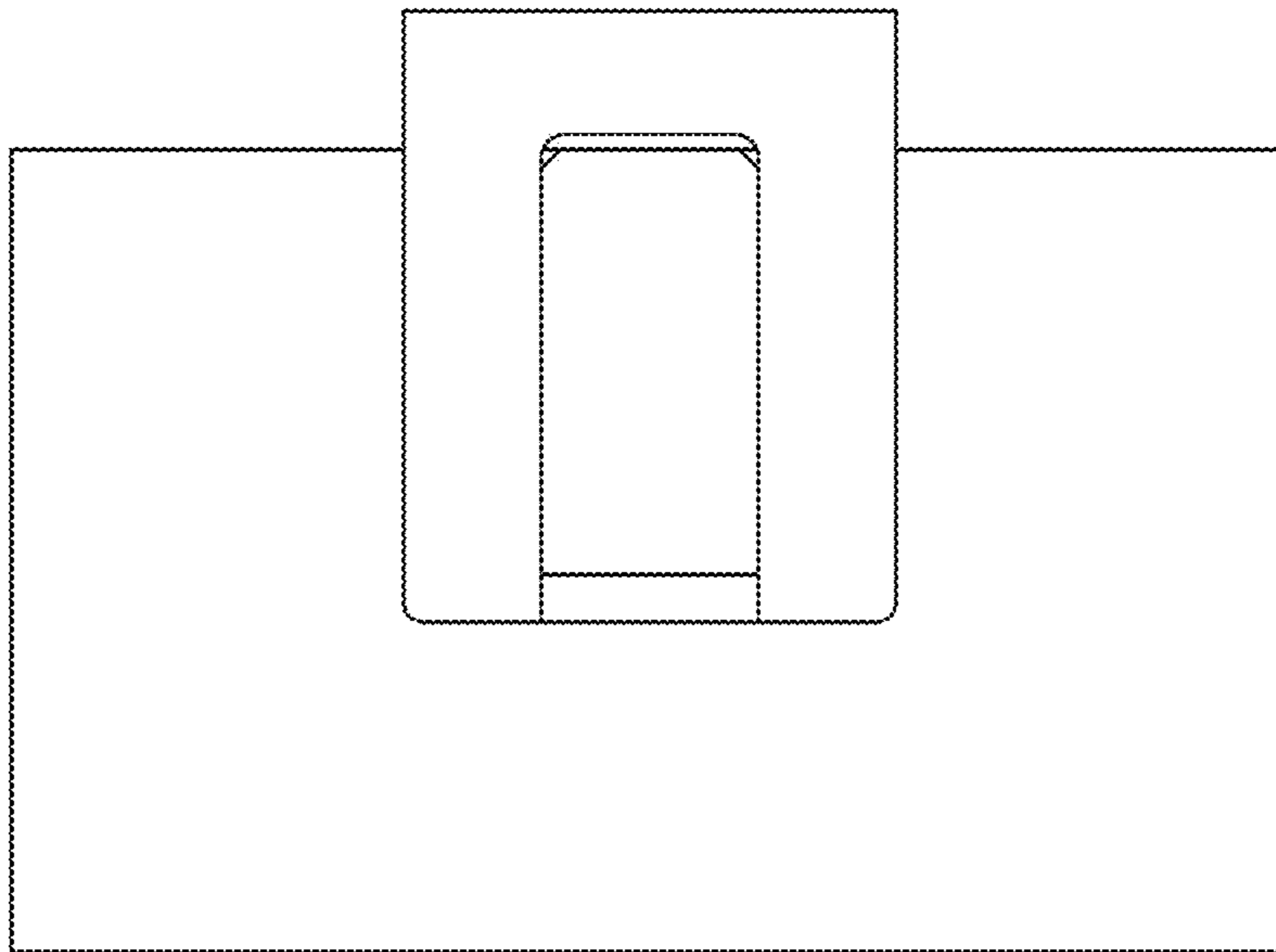

FIG. 23

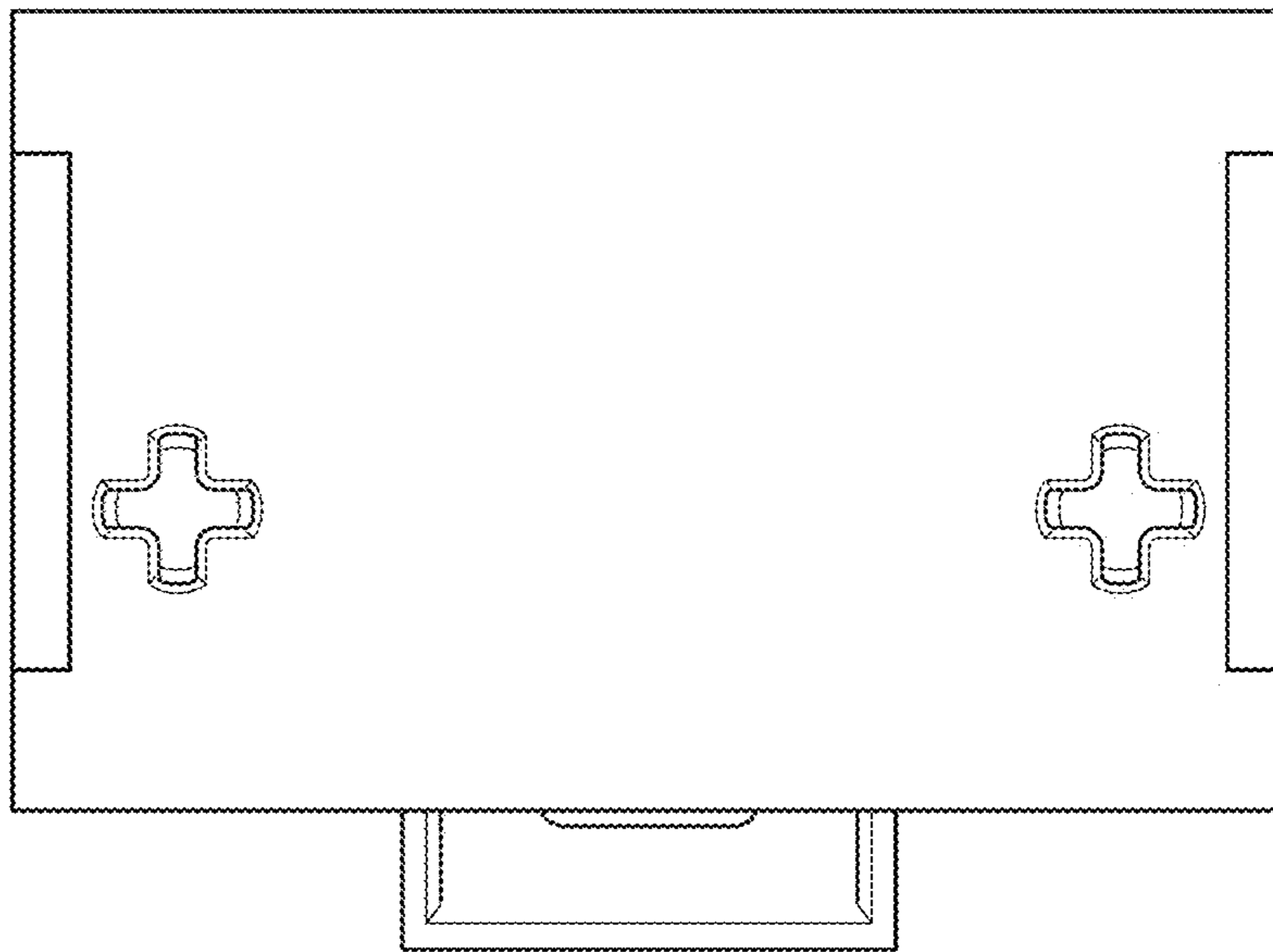

FIG. 24

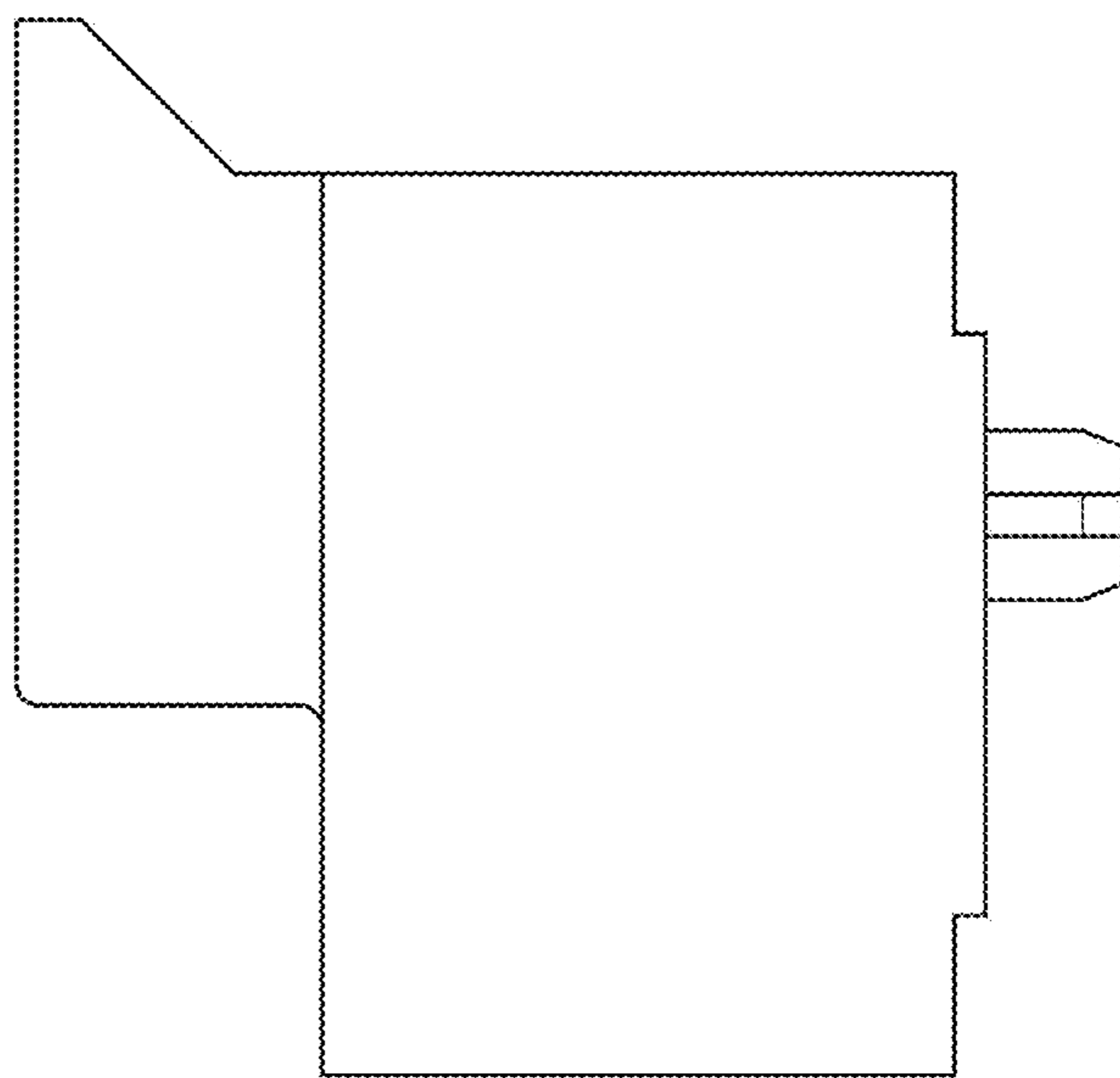

FIG. 25

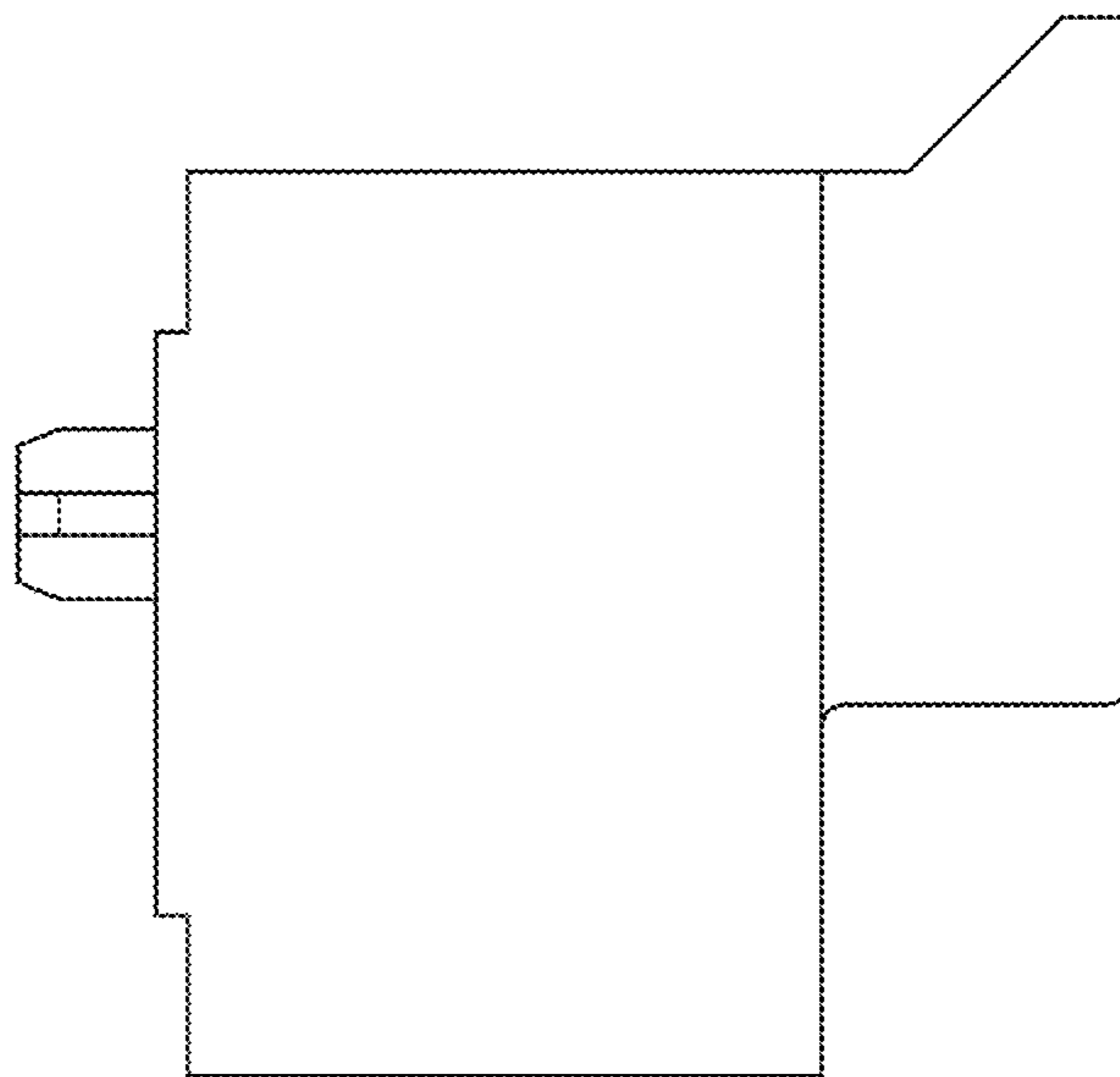

FIG. 26

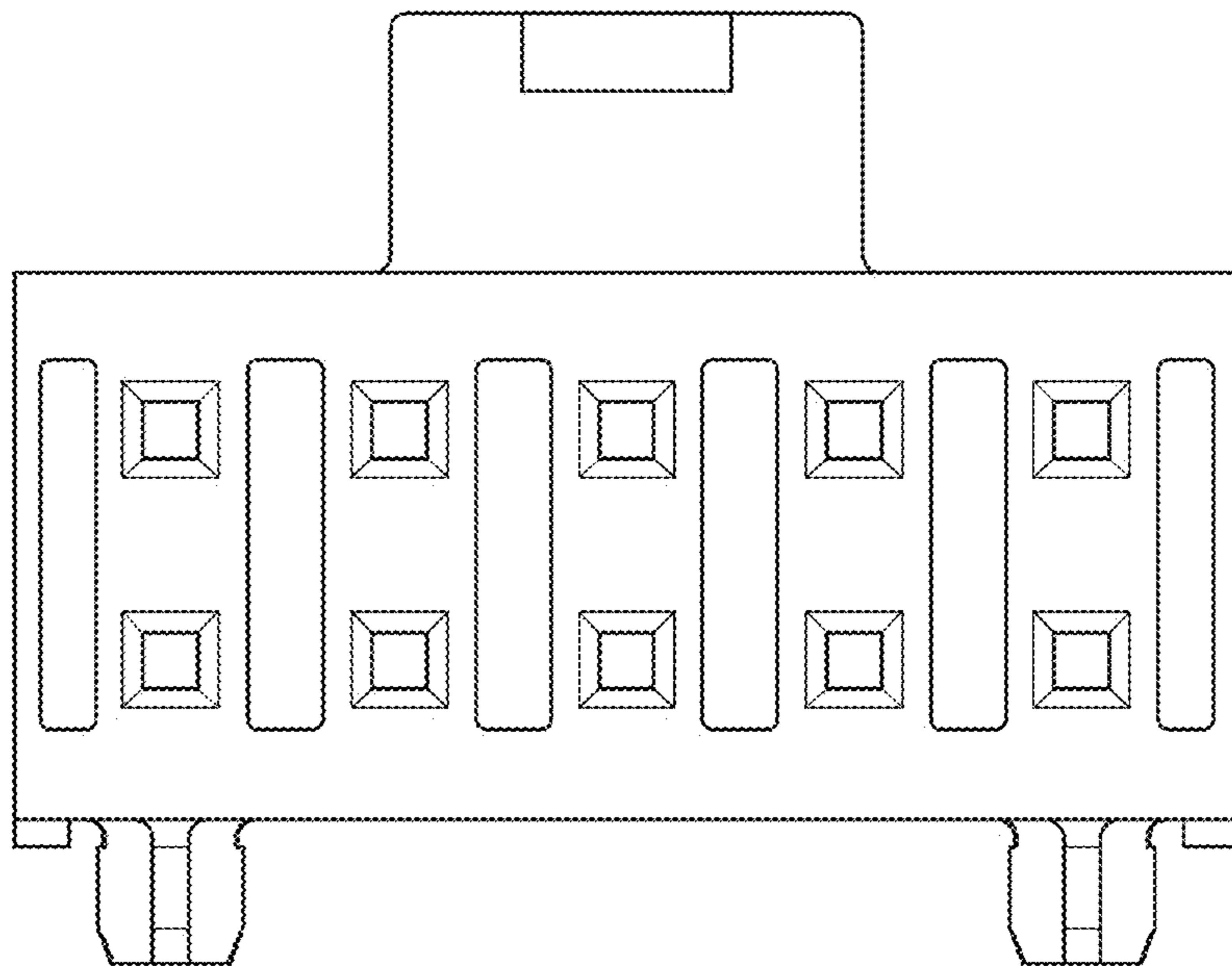

FIG. 27

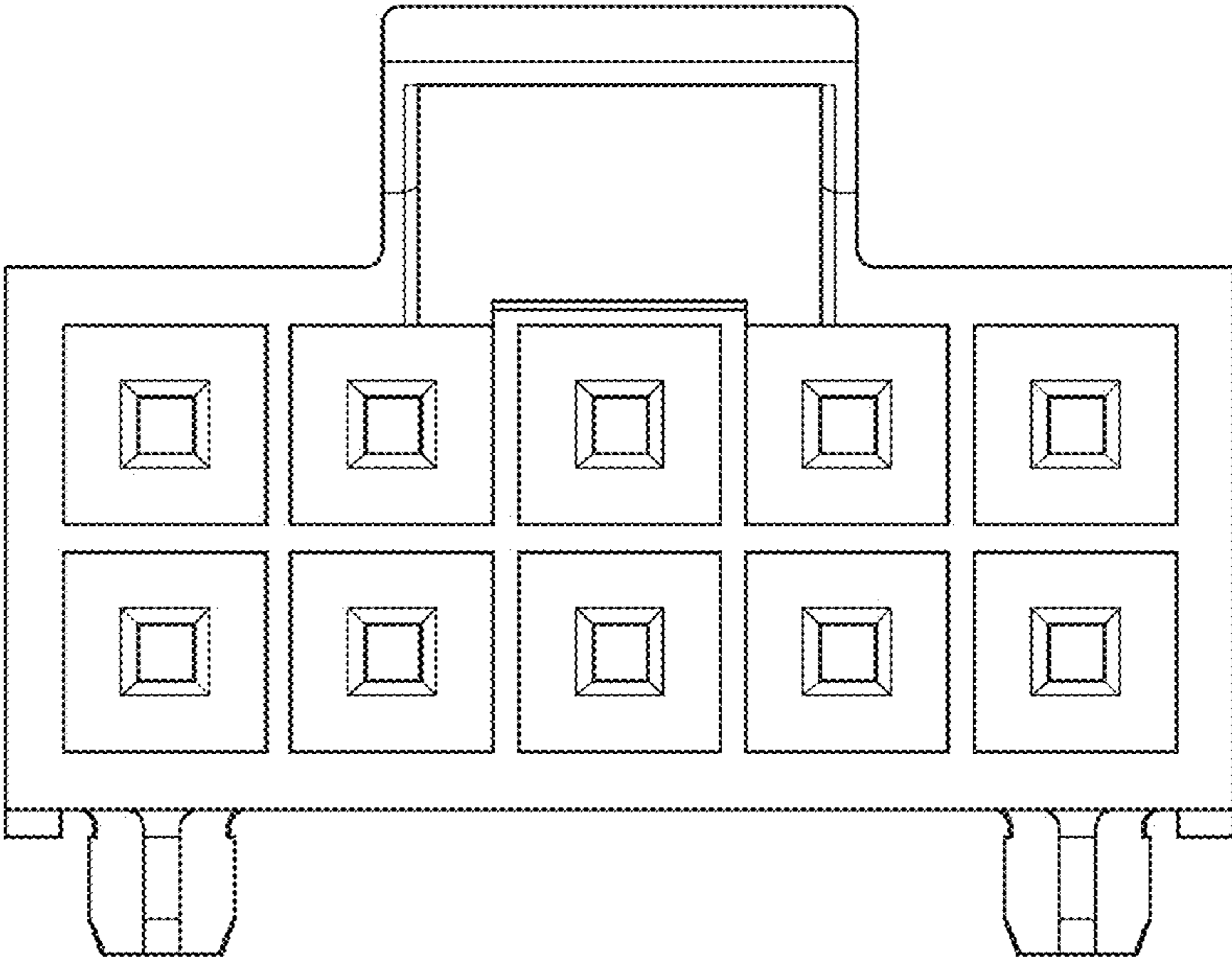

FIG. 28

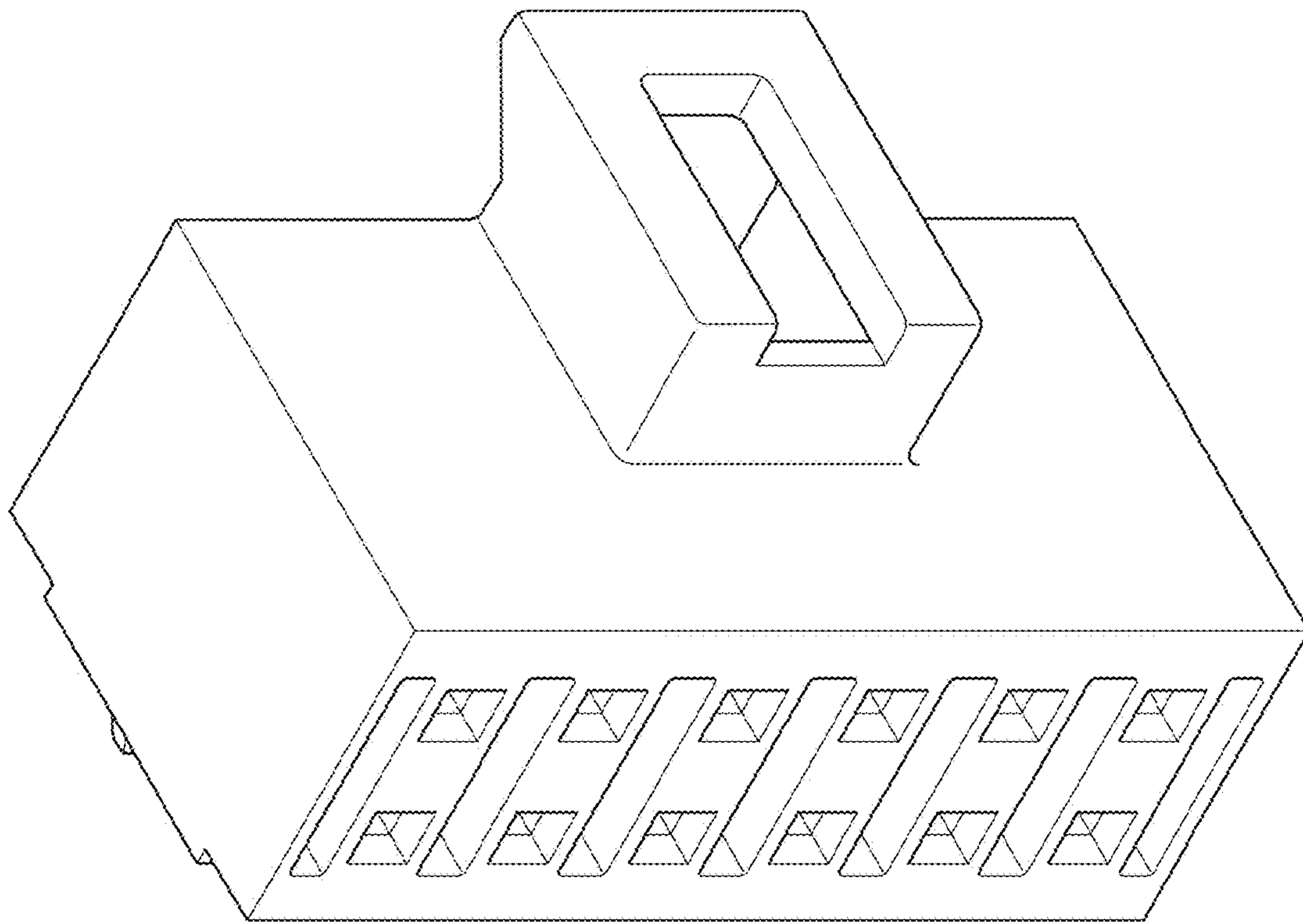

FIG. 29

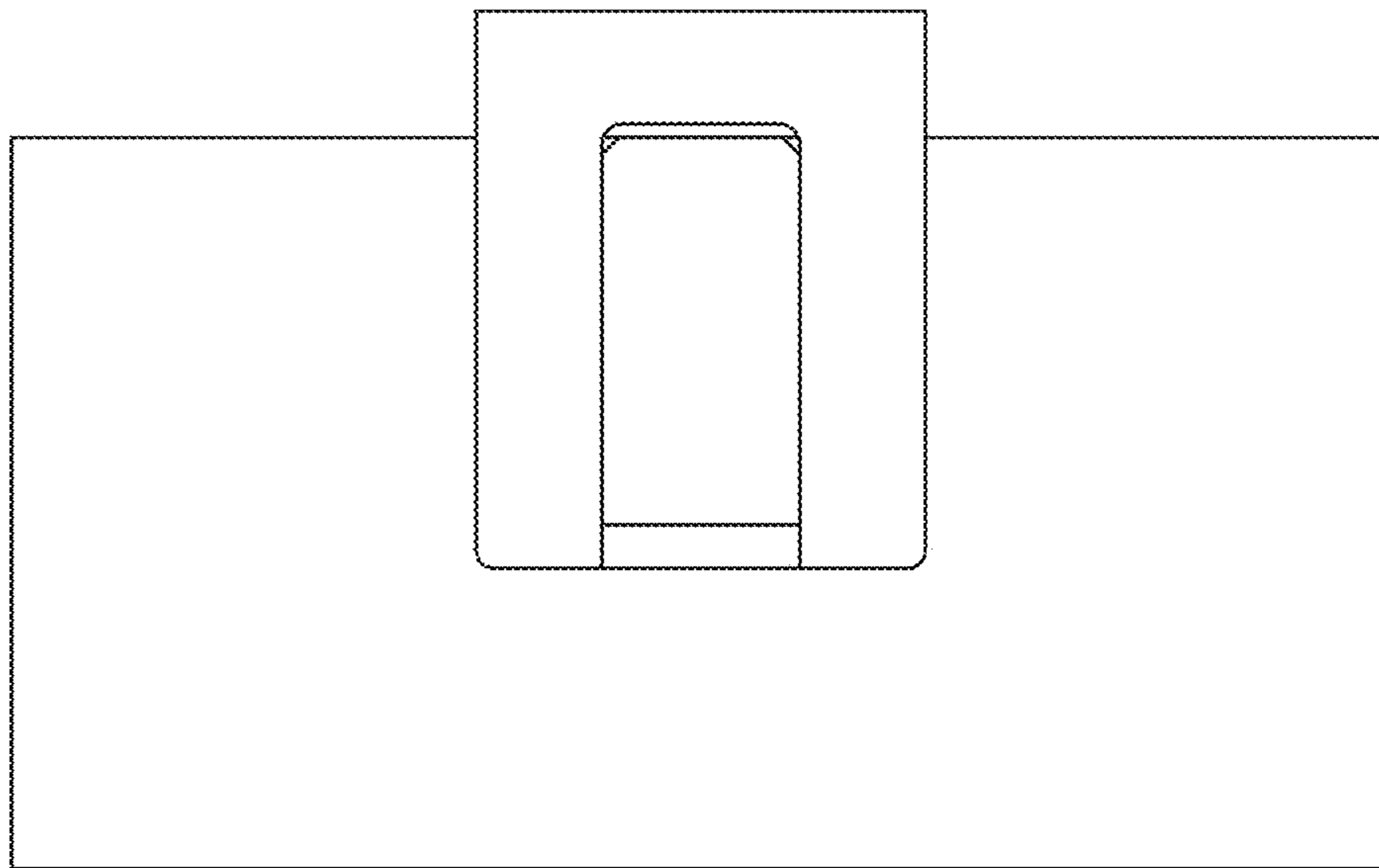

FIG. 30

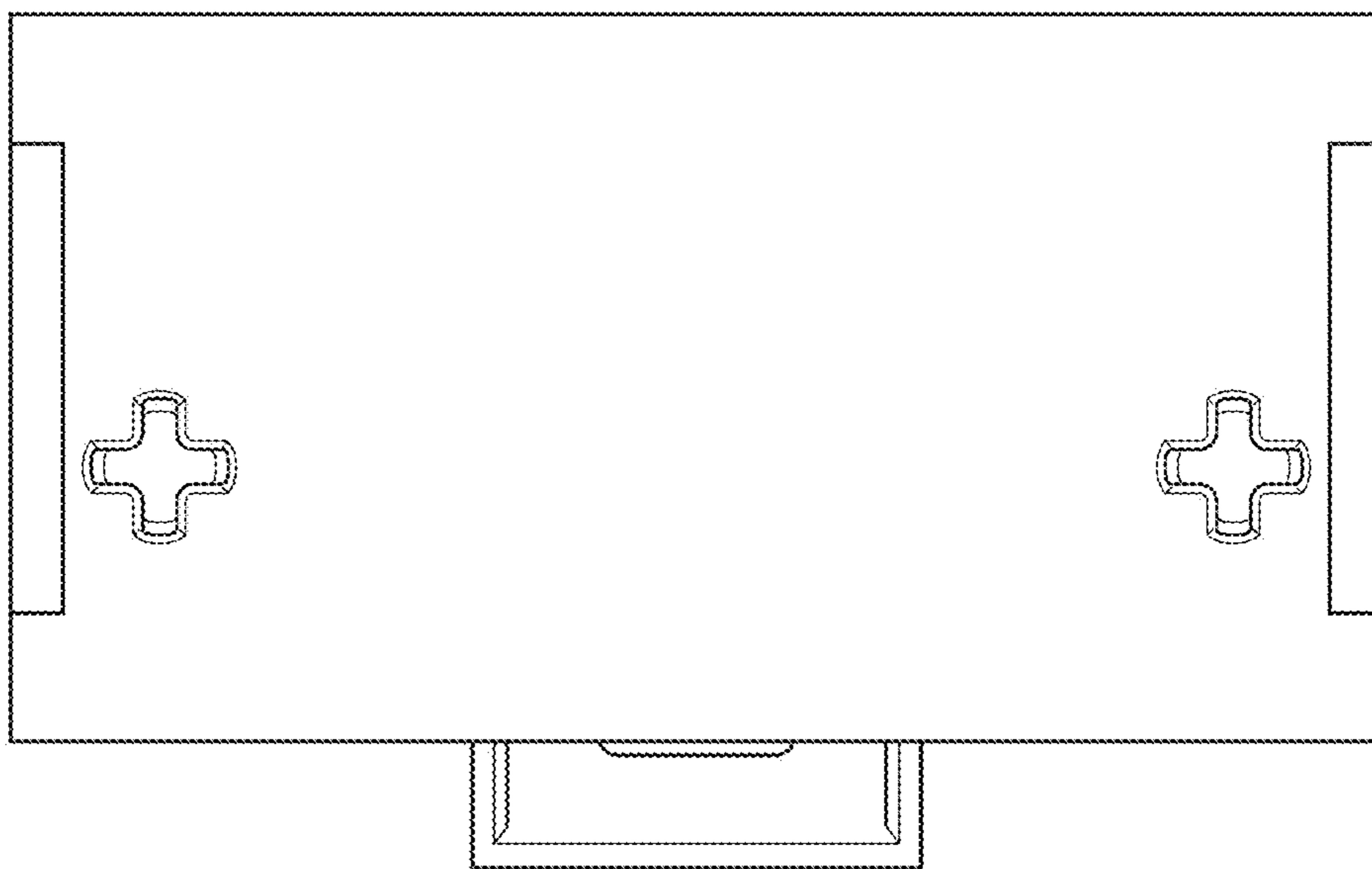

FIG. 31

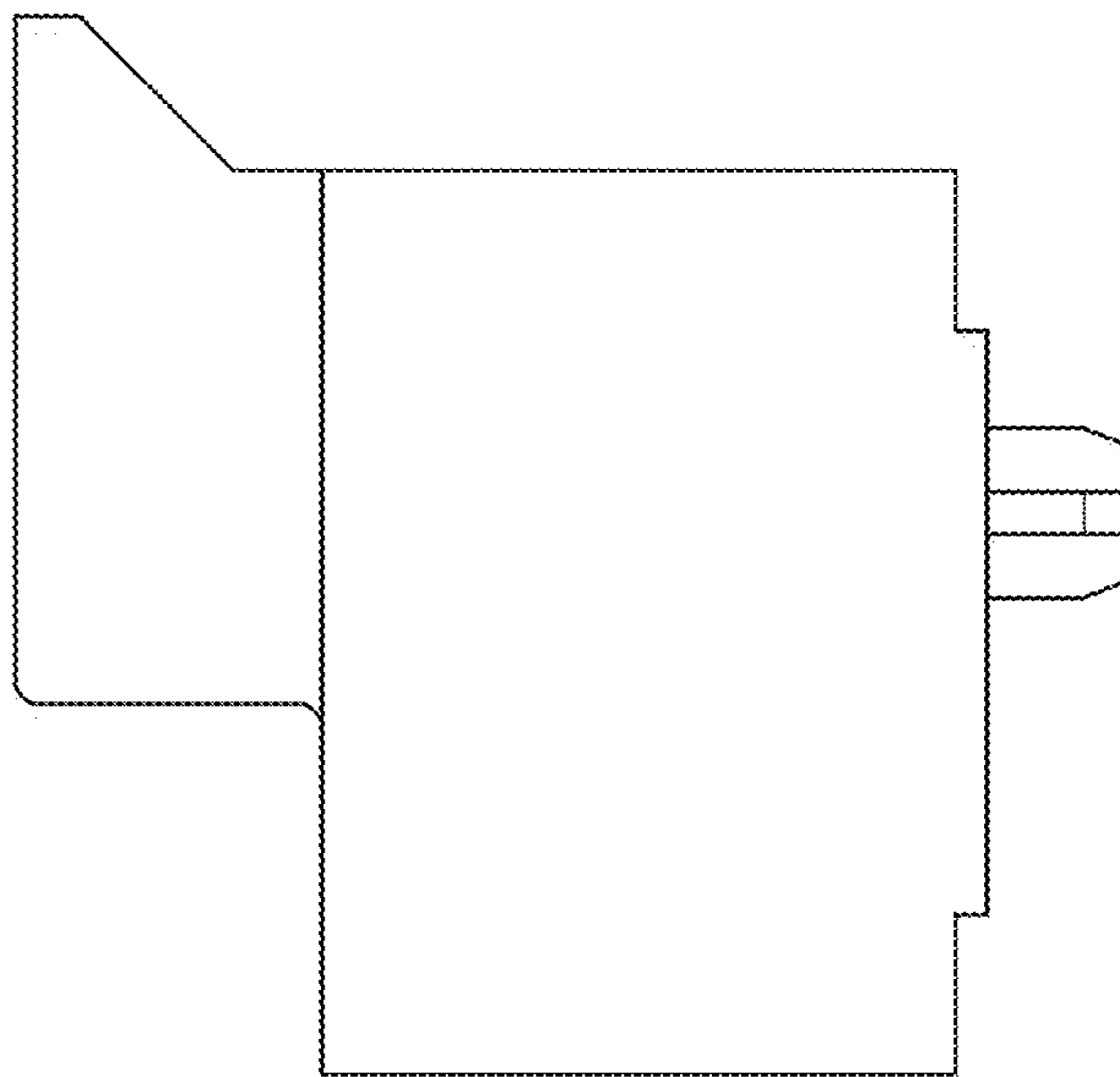

FIG. 32

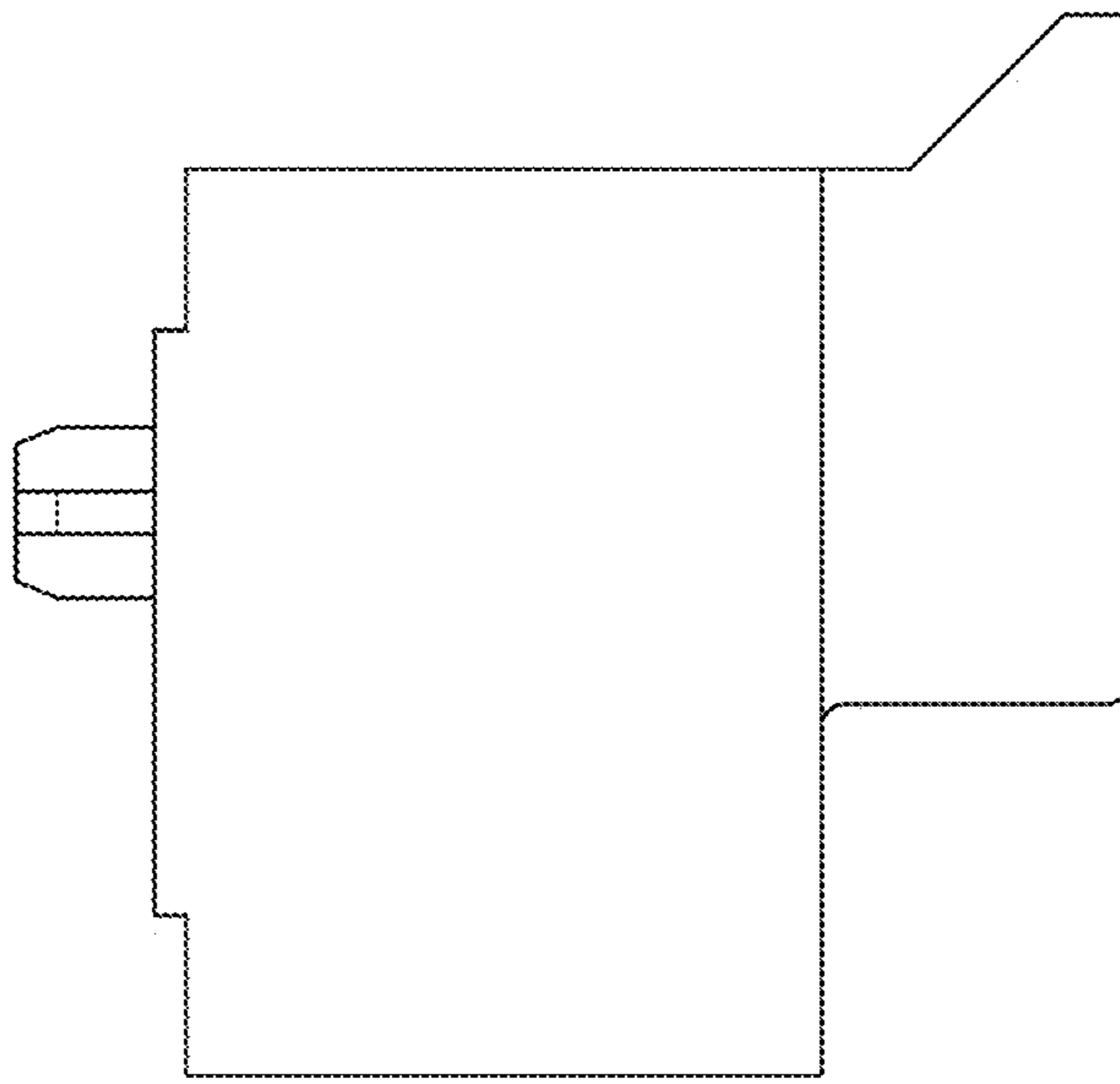

FIG. 33

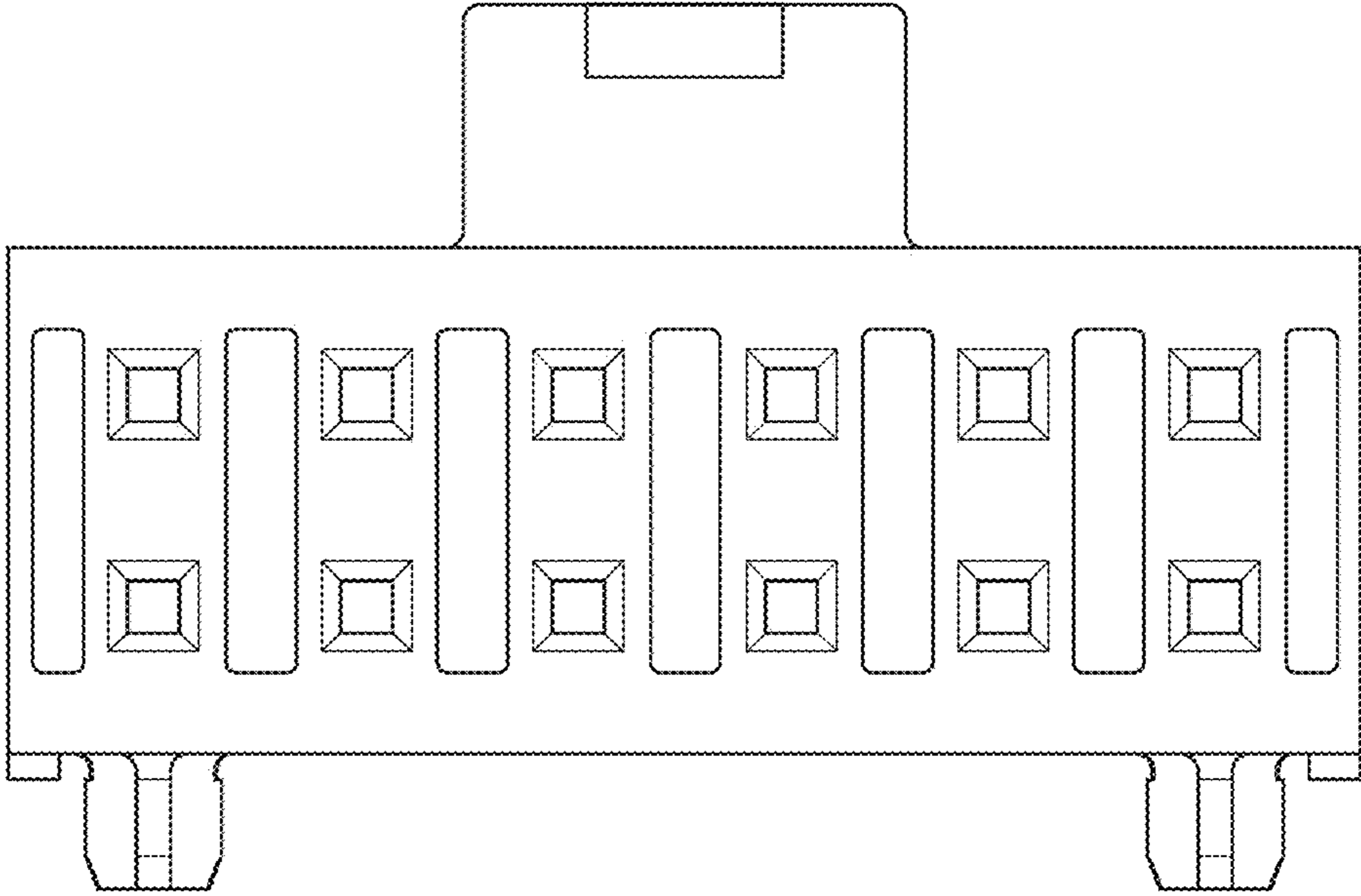

FIG. 34

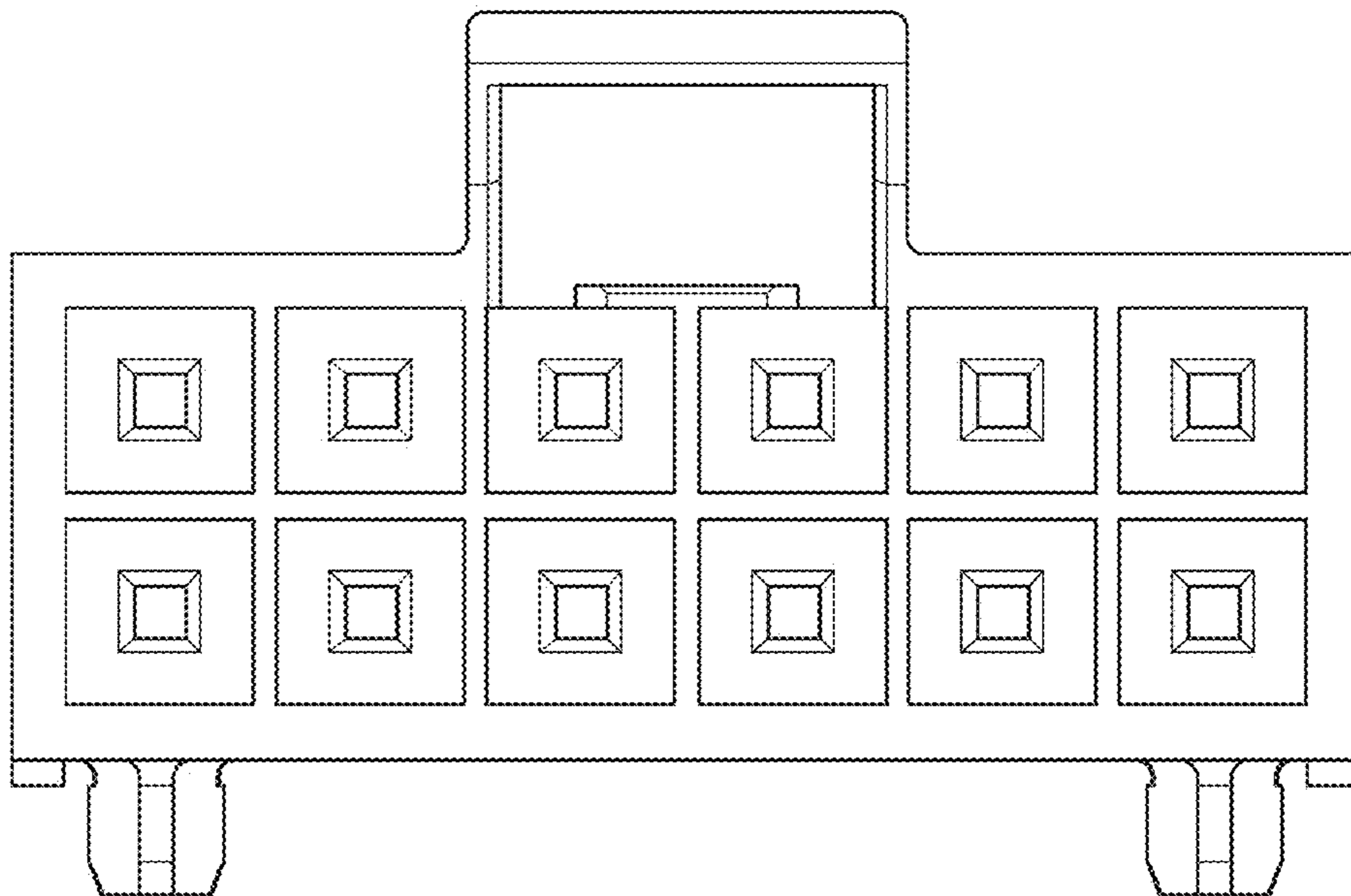

FIG. 35

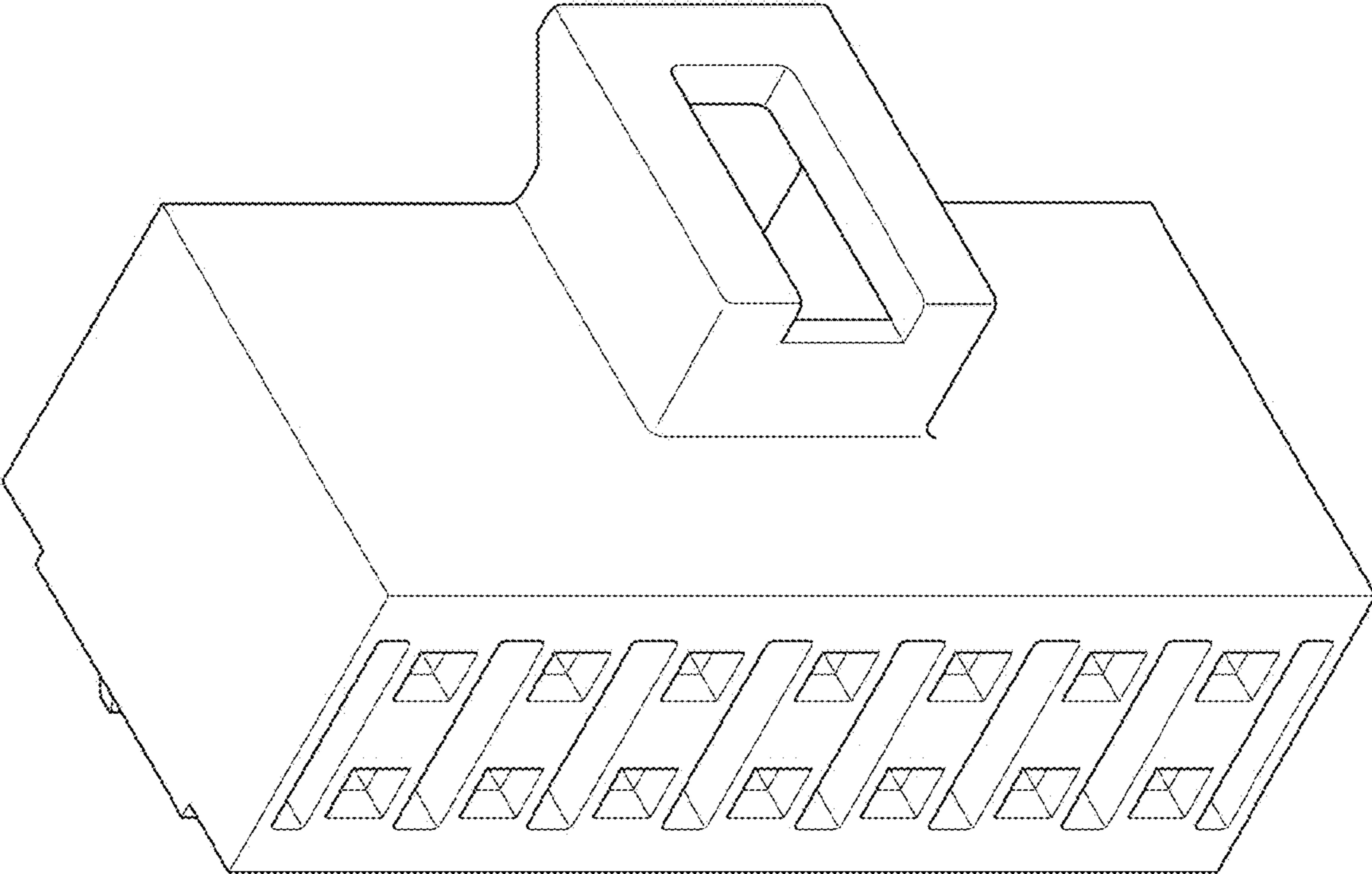

FIG. 36

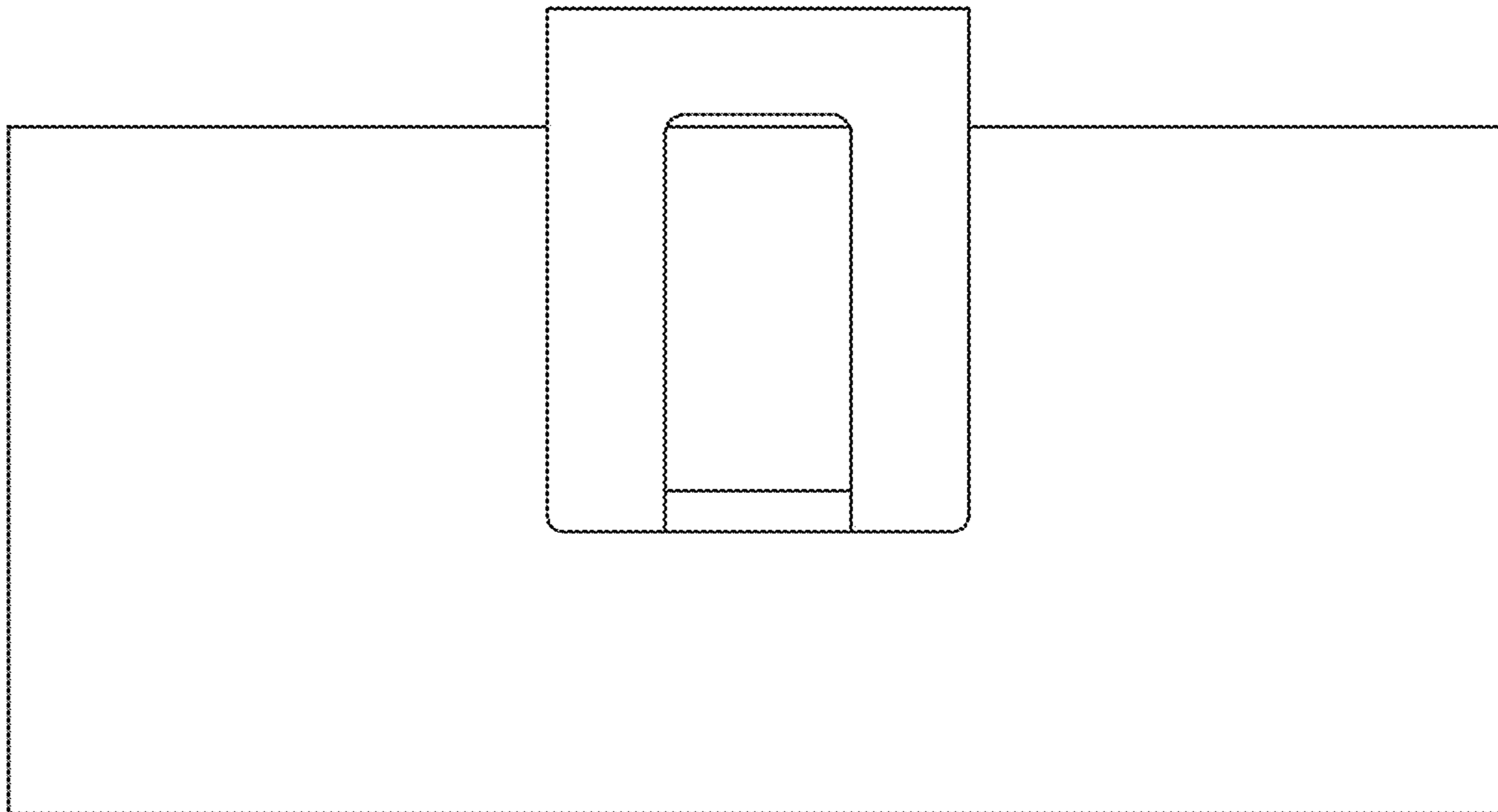

FIG. 37

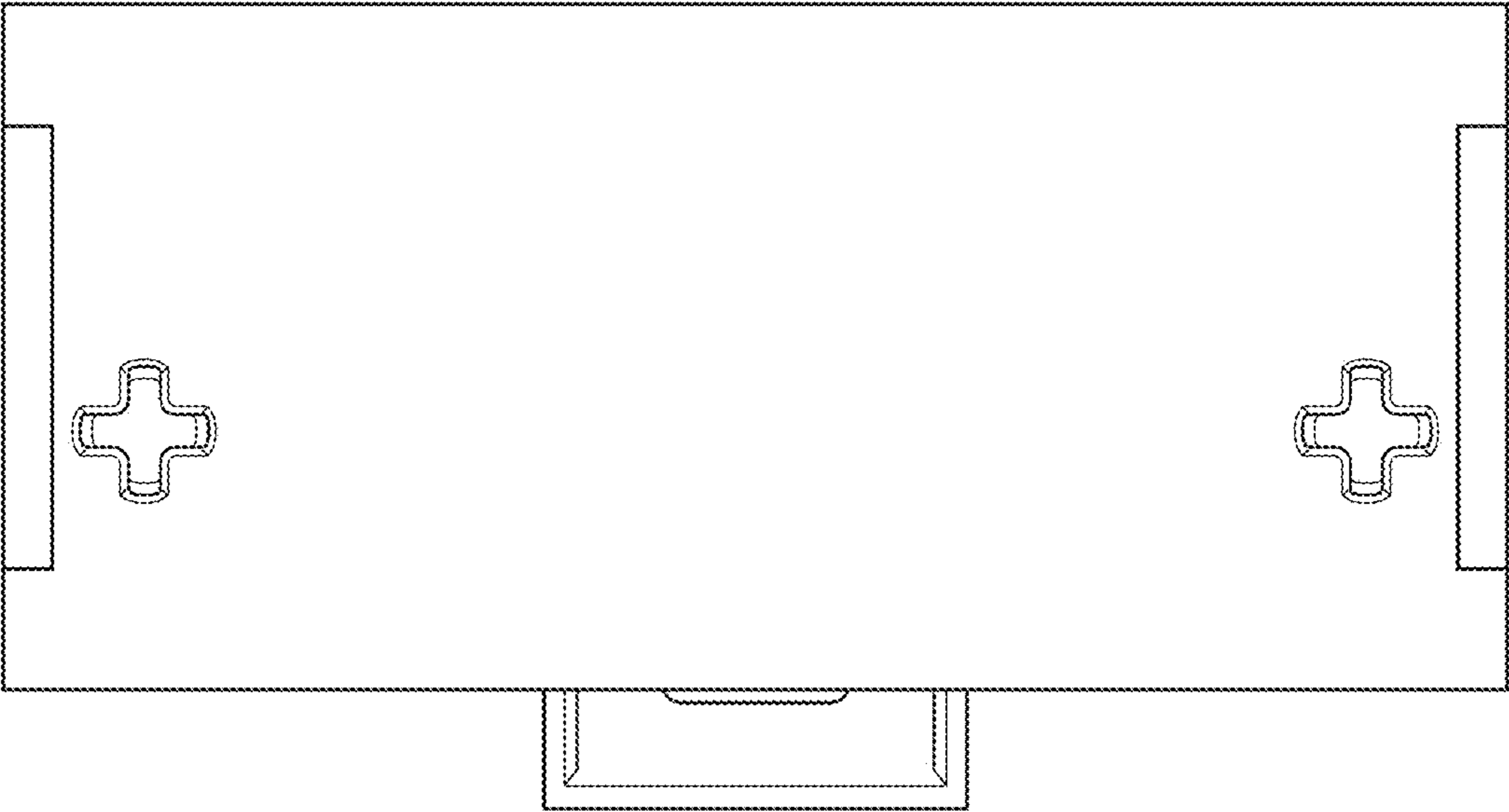

FIG. 38

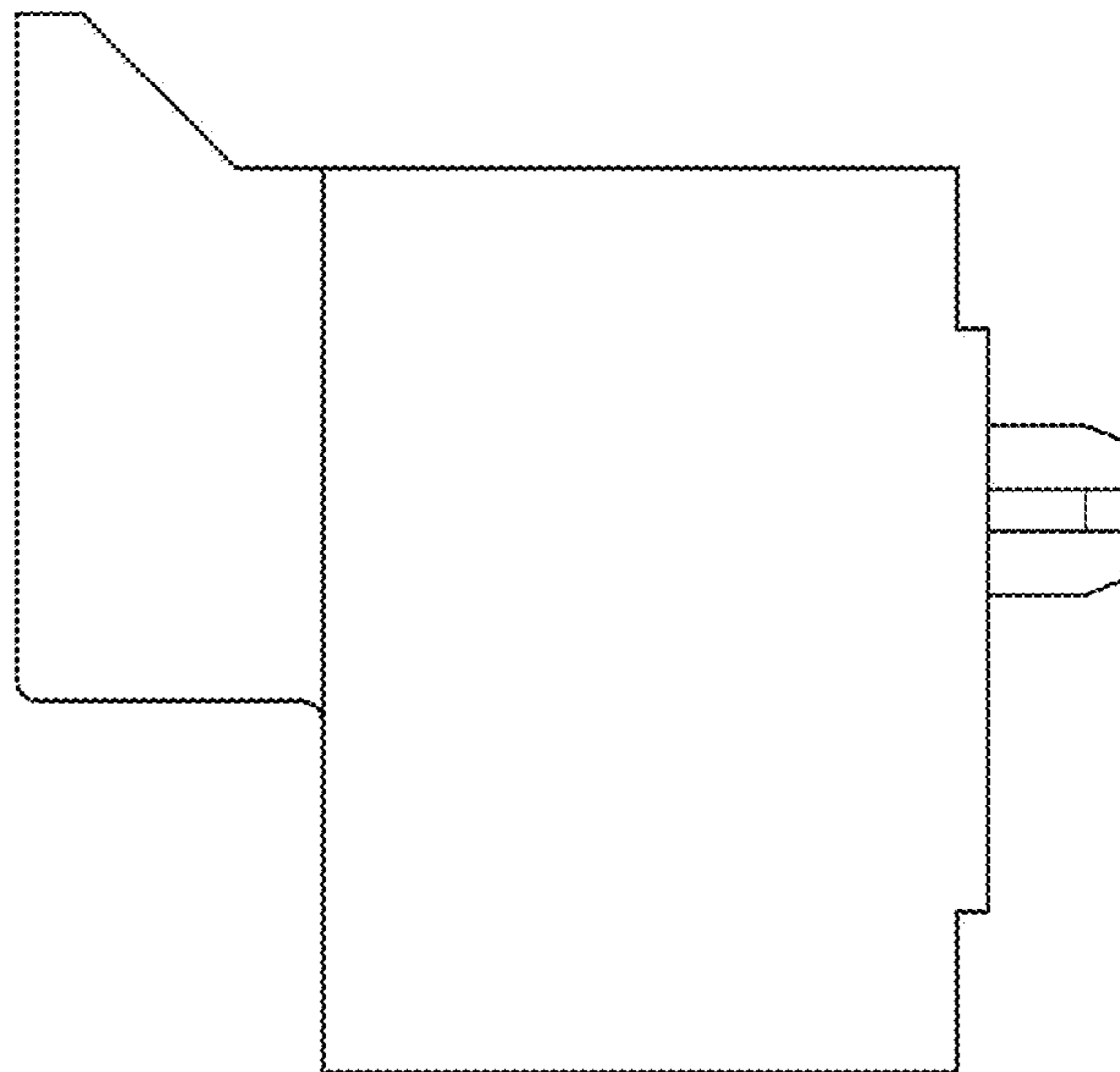

FIG. 39

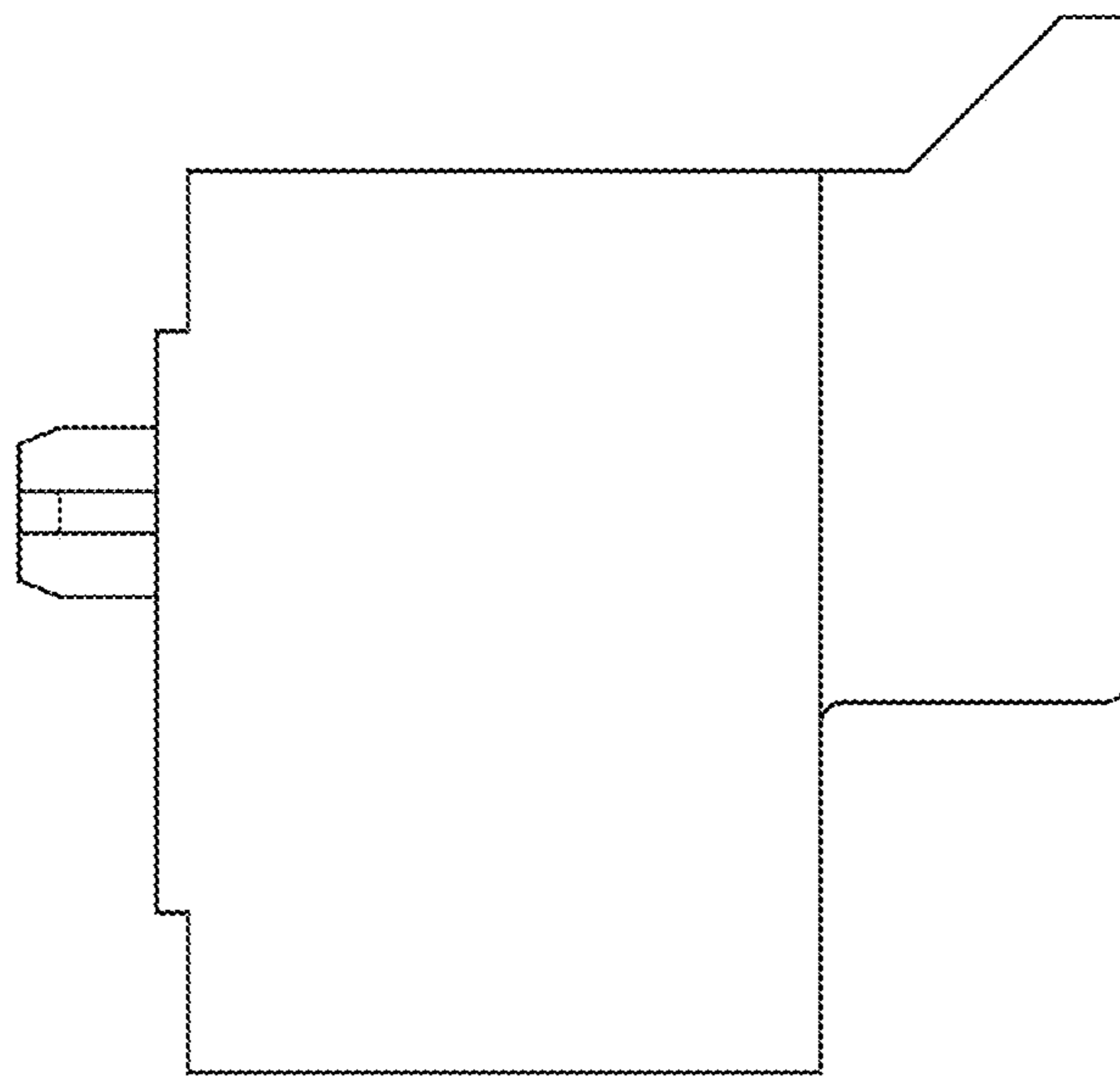

FIG. 40

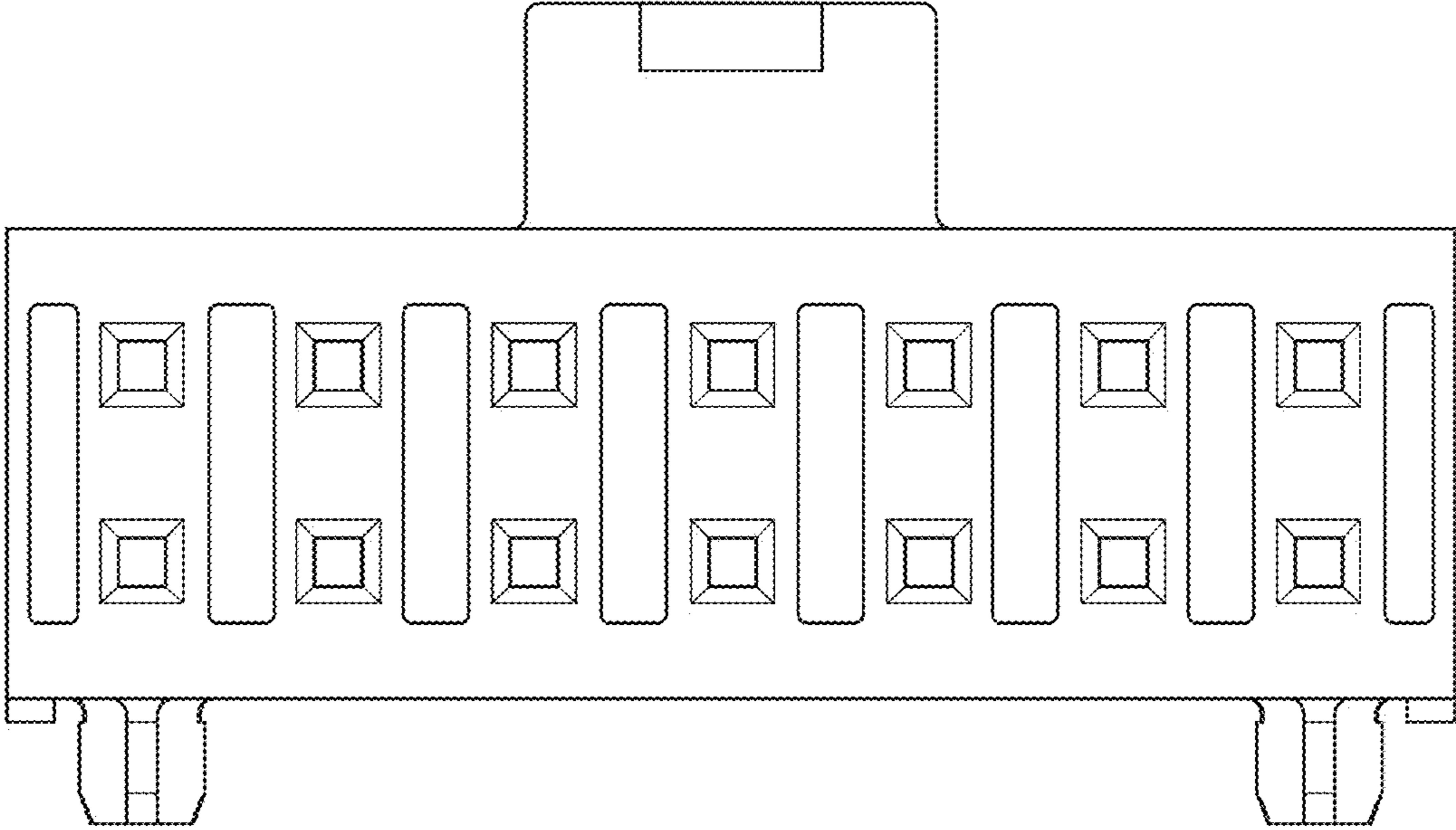

FIG. 41

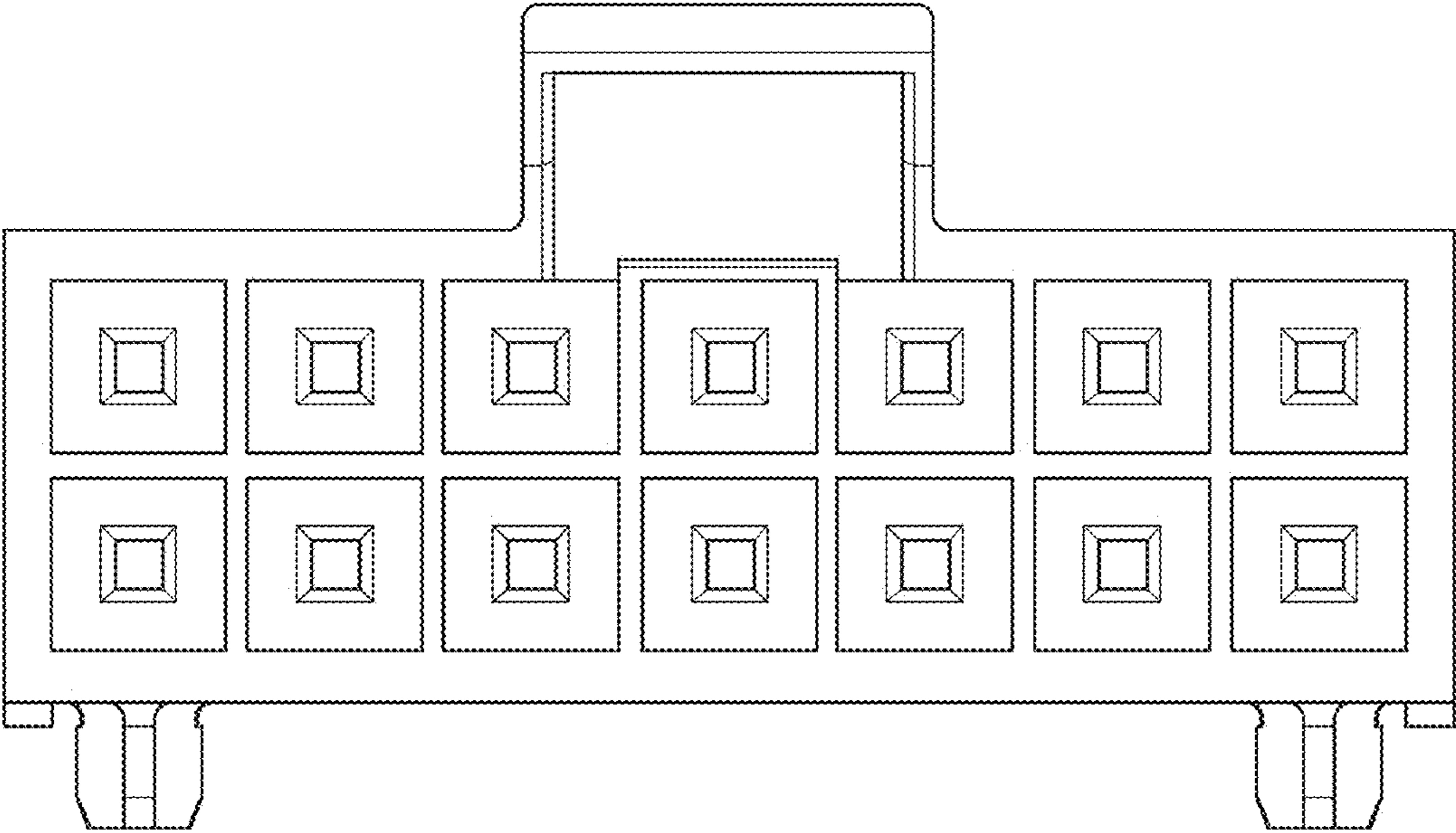

FIG. 42

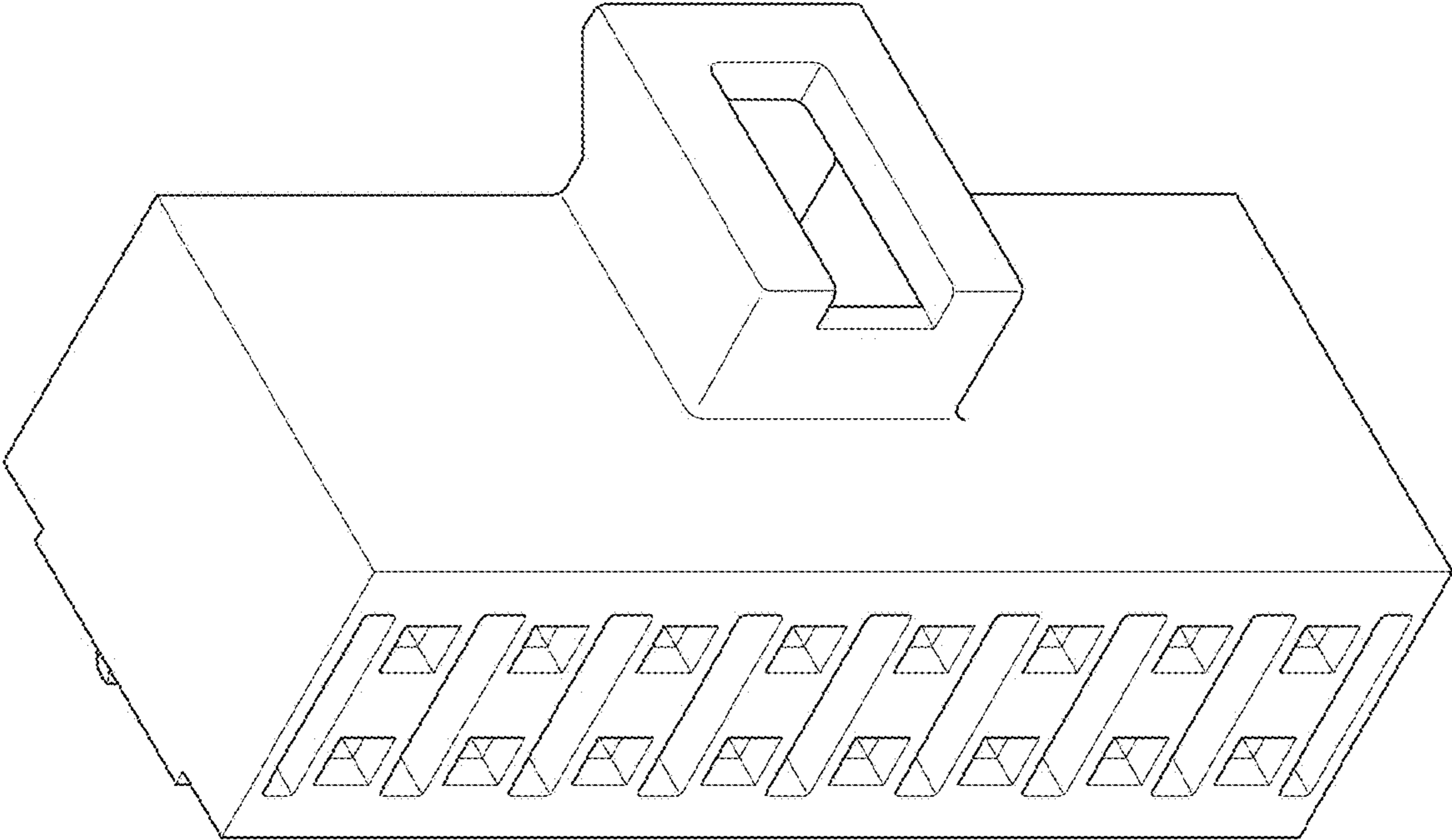

FIG. 43

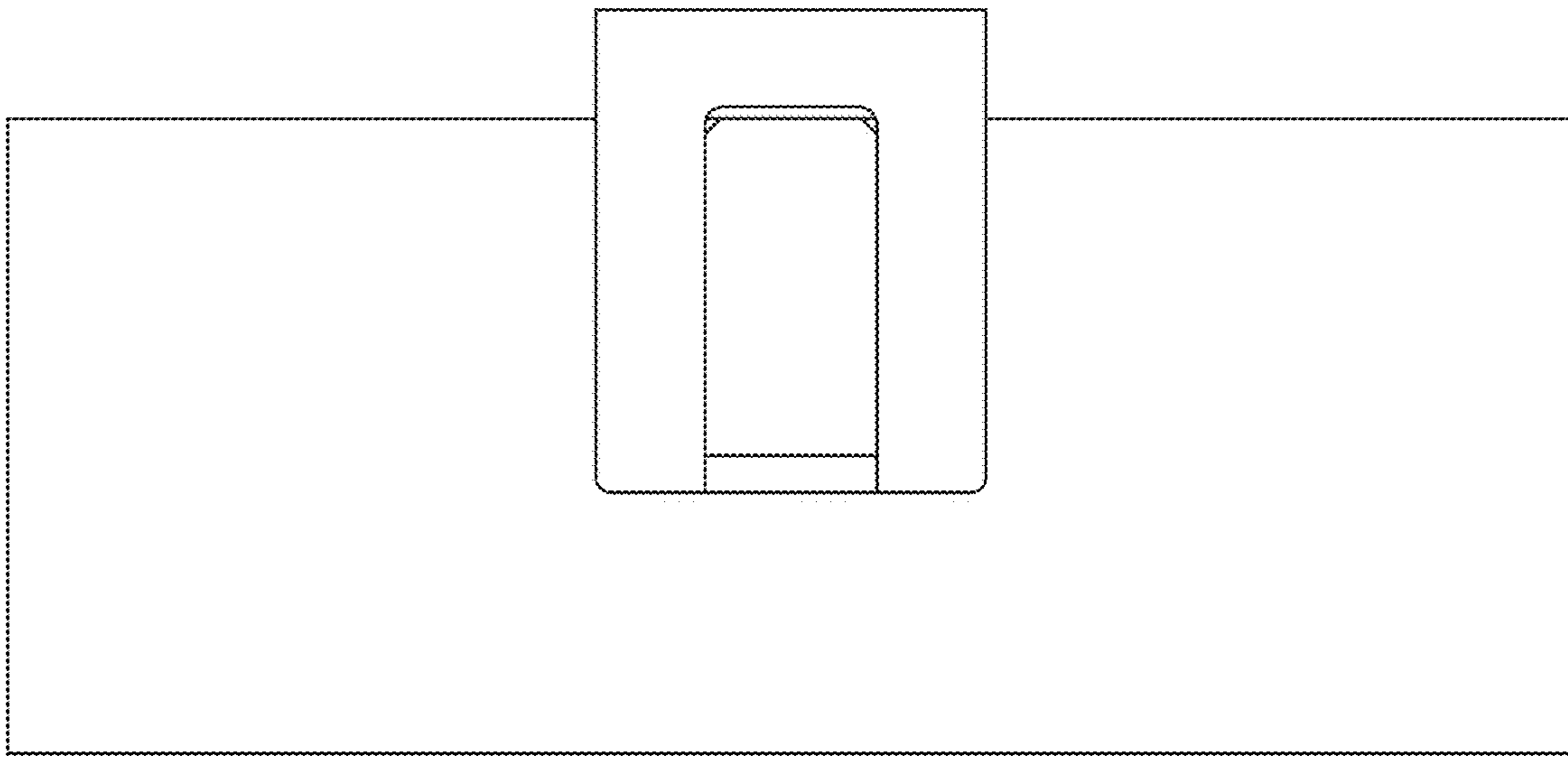

FIG. 44

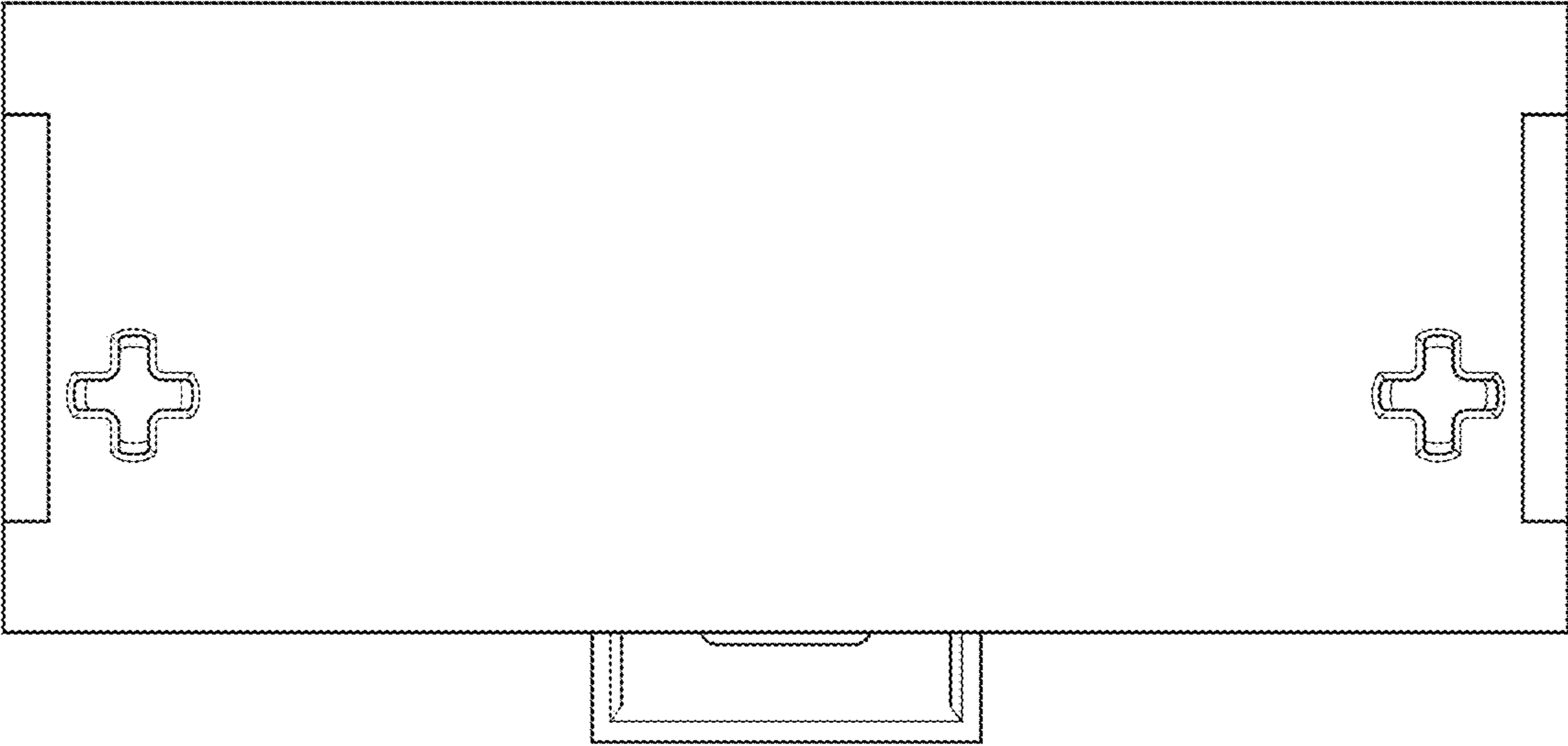

FIG. 45

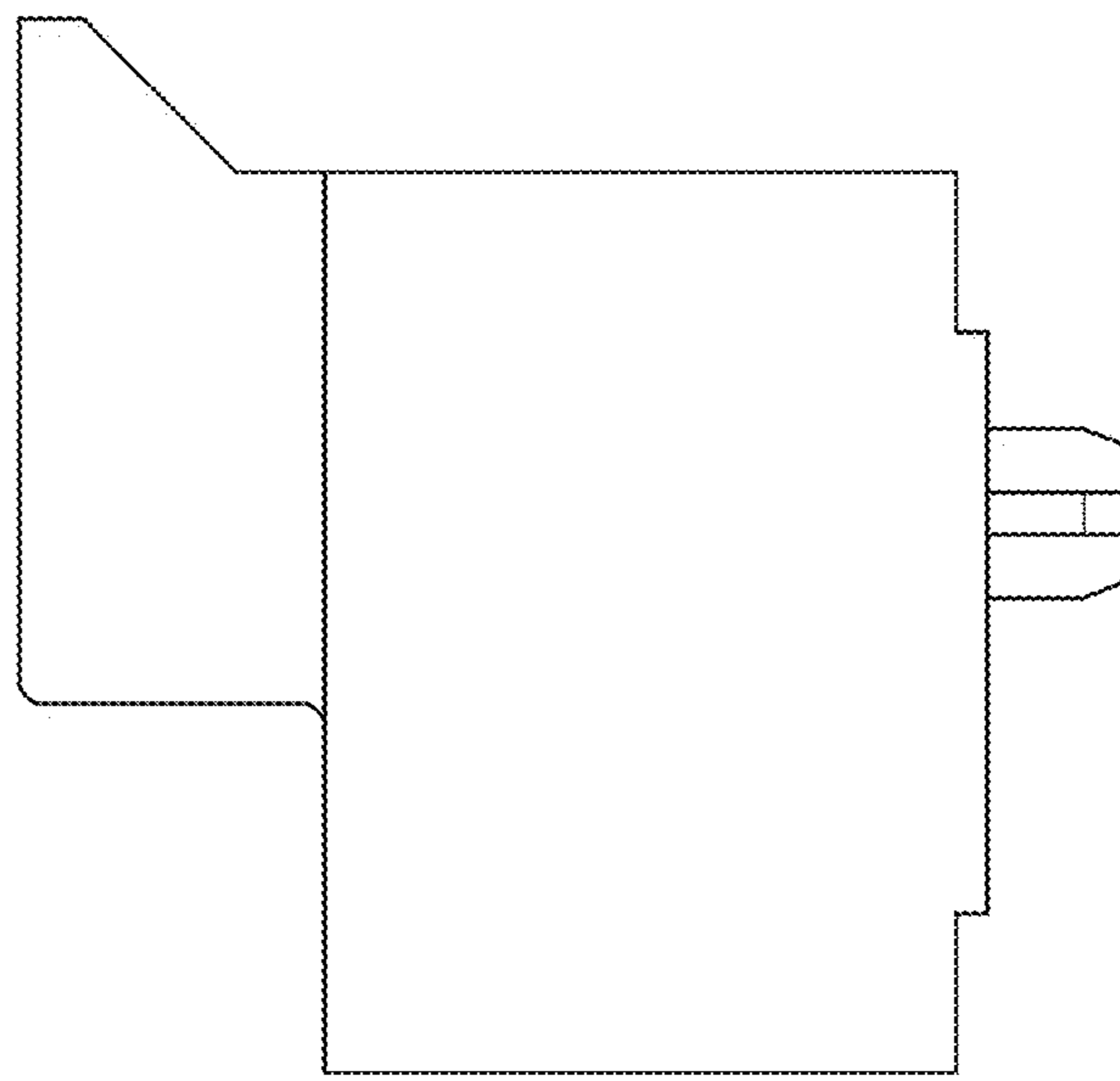

FIG. 46

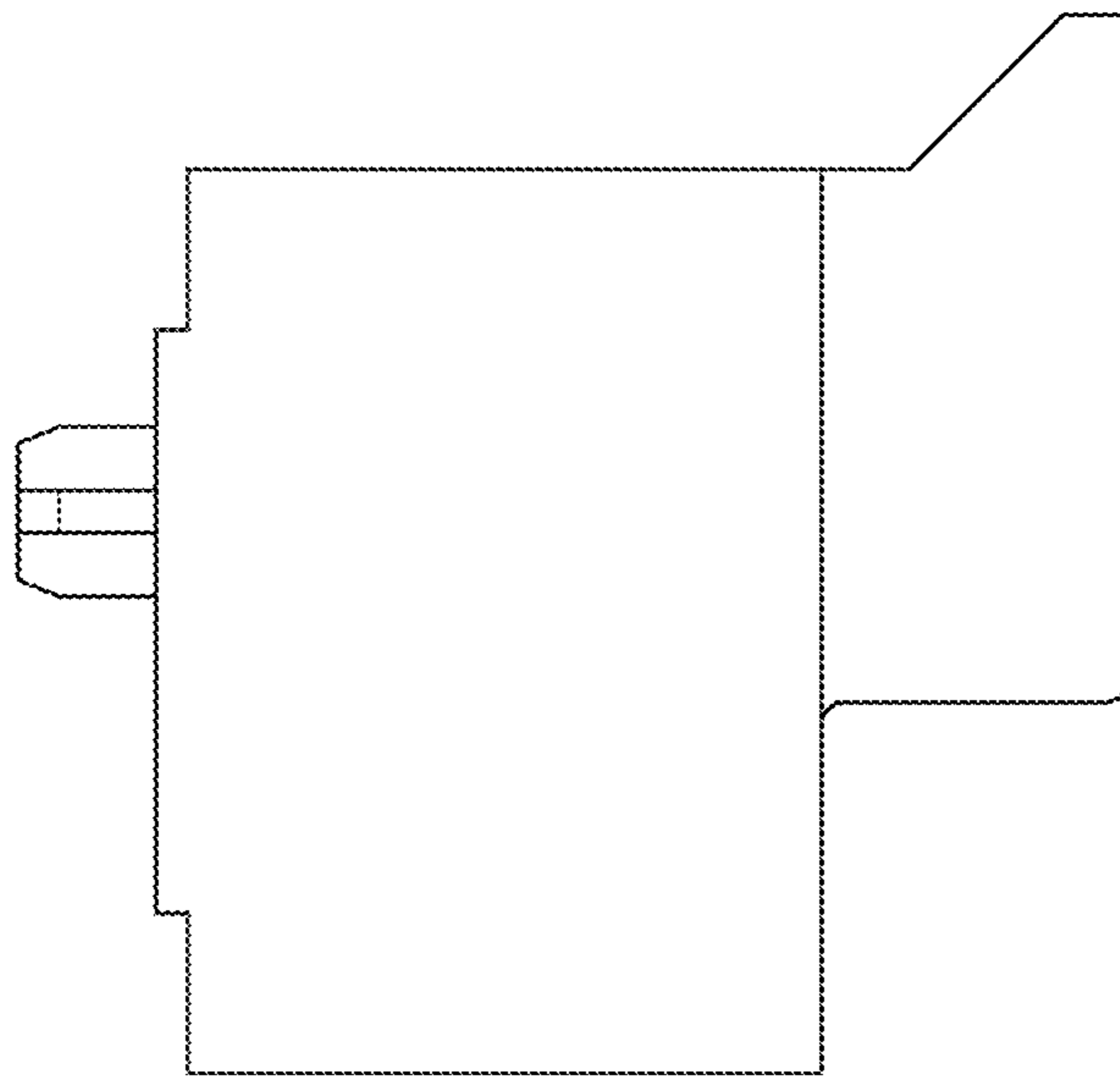

FIG. 47

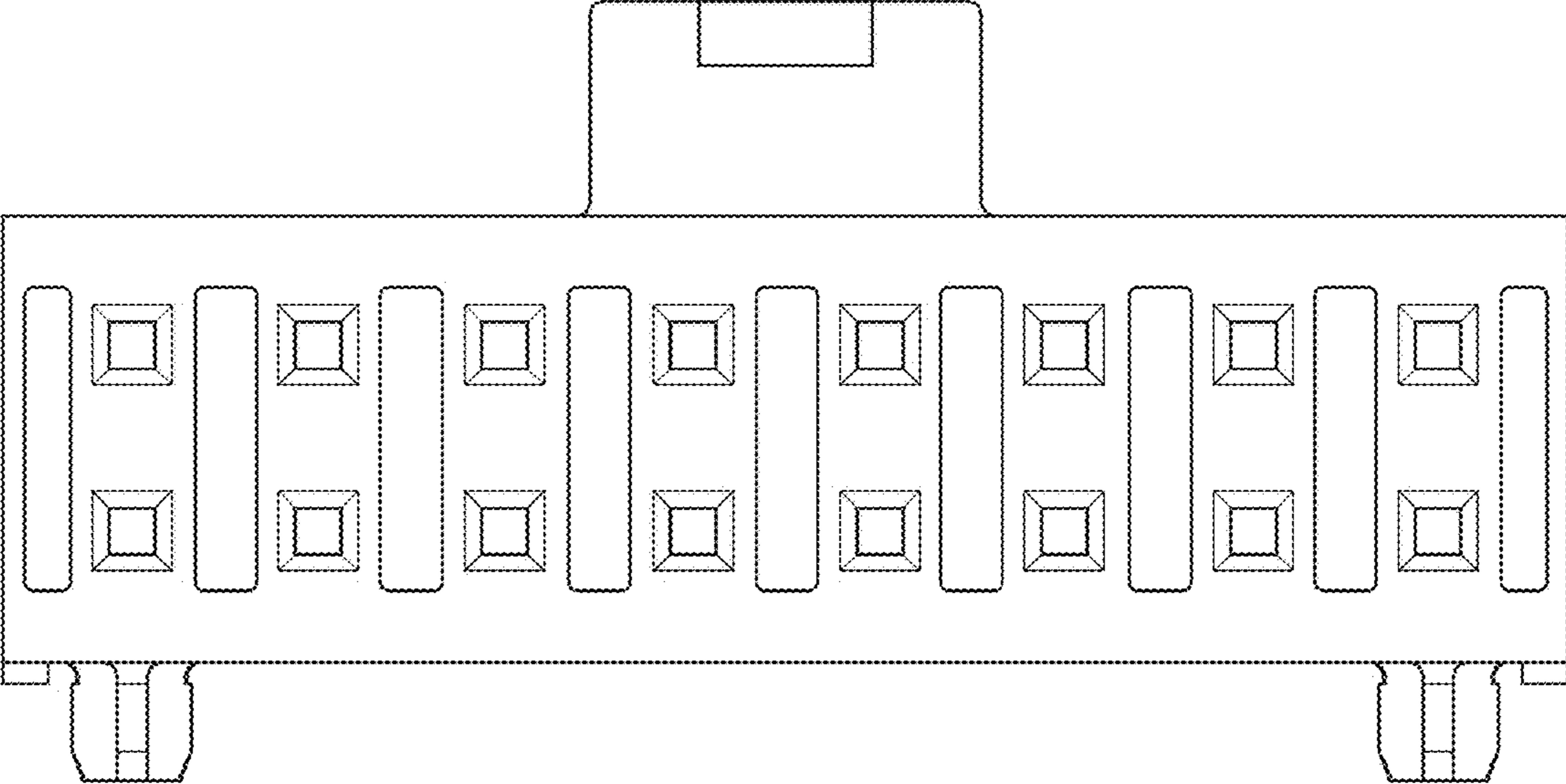

FIG. 48

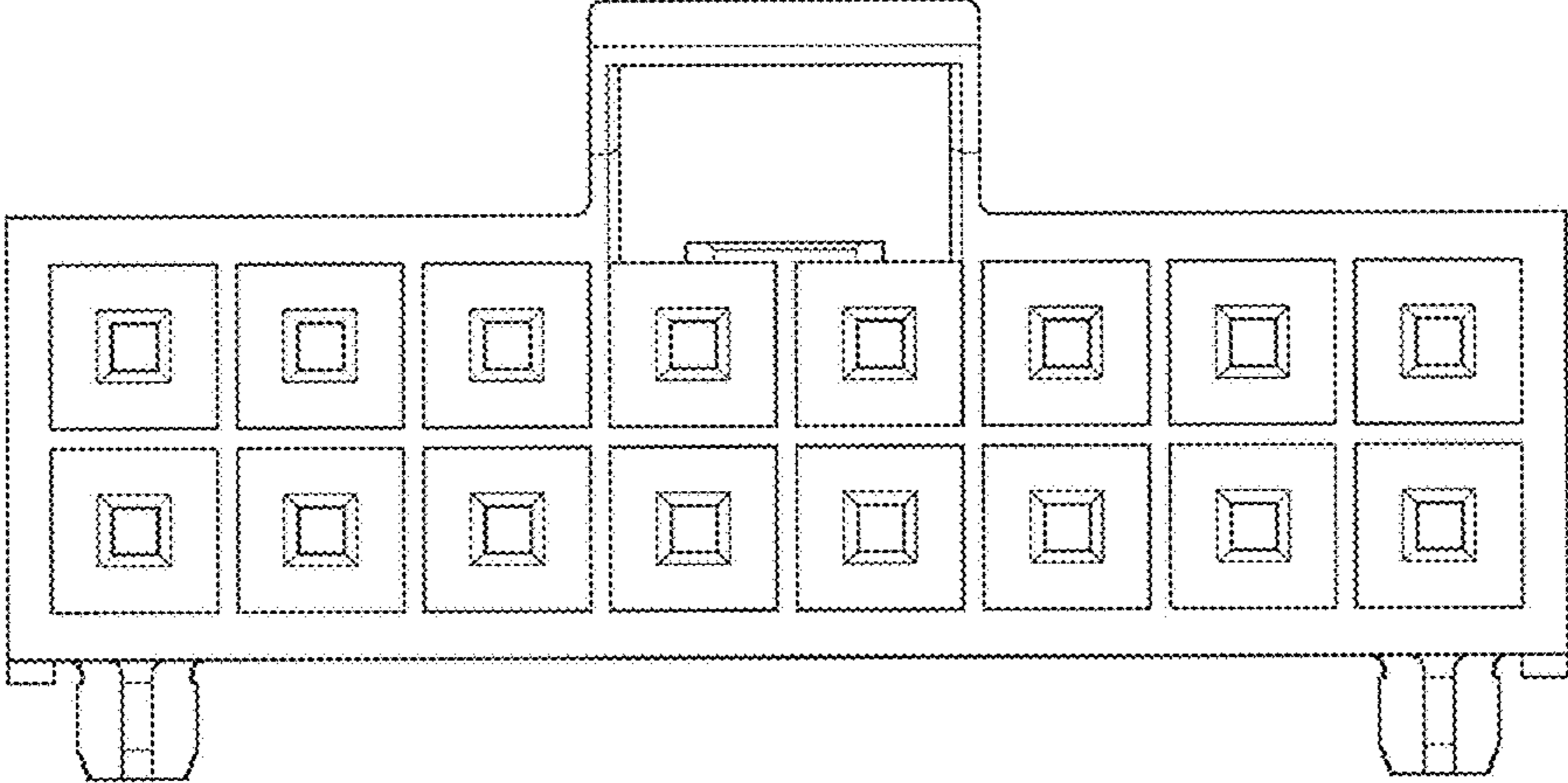

FIG. 49