

US00D792644S

(12) **United States Design Patent** (10) **Patent No.:** **US D792,644 S**
Jordan et al. (45) **Date of Patent:** **** Jul. 18, 2017**

(54) **ELECTRONIC VAPING DEVICE**

D254,930 S 5/1980 Mandon et al.
D254,931 S 5/1980 Mandon et al.
D267,121 S 11/1982 Min
4,429,703 A 2/1984 Haber

(71) Applicant: **Altria Client Services LLC**,
Richmond, VA (US)

(Continued)

(72) Inventors: **Geoffrey B. Jordan**, Midlothian, VA
(US); **Sean Sundberg**, Richmond, VA
(US); **Bipin Patil**, Richmond, VA (US);
Charles Dendy, Richmond, VA (US)

FOREIGN PATENT DOCUMENTS

CN 202890464 U 4/2013
WO WO-2013089358 A1 6/2013

(73) Assignee: **Altria Client Services LLC**,
Richmond, VA (US)

OTHER PUBLICATIONS

US D749,259, (withdrawn).

(**) Term: **15 Years**

(Continued)

(21) Appl. No.: **29/579,734**

Primary Examiner — Robert M Spear

(22) Filed: **Oct. 3, 2016**

Assistant Examiner — Marissa J Cash

(74) *Attorney, Agent, or Firm* — Harness, Dickey &
Pierce, P.L.C.

Related U.S. Application Data

(63) Continuation of application No. 29/531,427, filed on
Jun. 25, 2015, now abandoned.

(51) **LOC (10) Cl.** **27-01**

(52) **U.S. Cl.**

USPC **D27/101**

(58) **Field of Classification Search**

CPC A24F 47/00; A24F 47/002; A24B 15/243;
A24B 15/16; A24B 15/167; A61M
11/042; A61M 15/06

See application file for complete search history.

(56) **References Cited**

U.S. PATENT DOCUMENTS

D142,842 S 11/1945 Daze
D212,753 S 11/1968 Tughan
3,587,573 A 6/1971 Flack
3,720,235 A 3/1973 Schrock
D229,725 S 12/1973 Berger
D229,788 S 1/1974 Berger
D229,789 S 1/1974 Berger
D229,790 S 1/1974 Berger

(57) **CLAIM**

The ornamental design for an electronic vaping device, as
shown and described.

DESCRIPTION

FIG. 1 is a rear perspective view of the electronic vaping
device;

FIG. 2 is a rear view of the electronic vaping device;

FIG. 3 is a front view of the electronic vaping device;

FIG. 4 is a side view of the electronic vaping device;

FIG. 5 is a top view of the electronic vaping device;

FIG. 6 is a bottom view of the charger with electronic vaping
device; and,

FIG. 7 is a front perspective view of the electronic vaping
device.

In the drawings, the broken lines on the electronic vaping
device end in FIGS. 3 and 7 depict environmental subject
matter only and form no part of the claimed design.

1 Claim, 4 Drawing Sheets

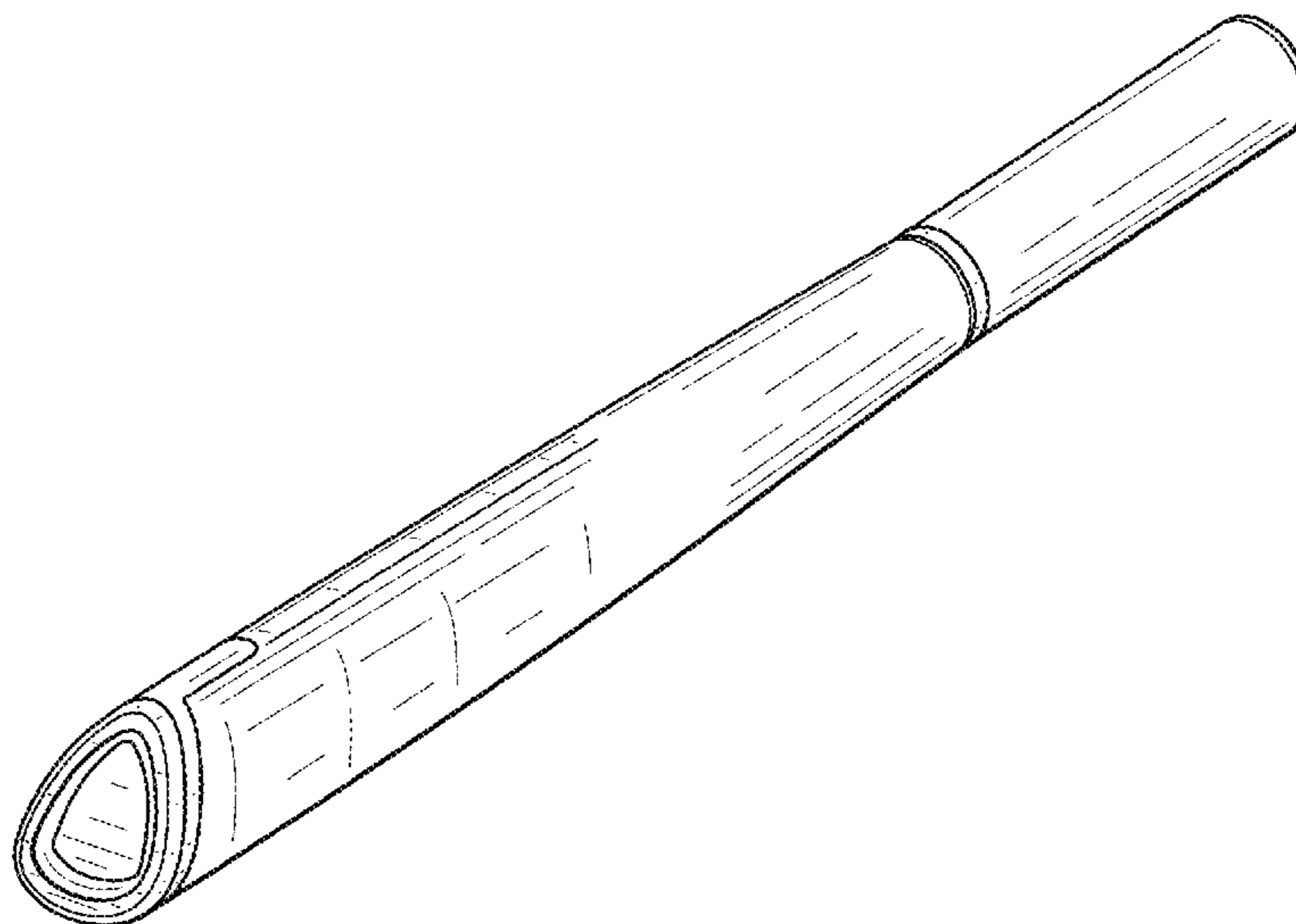

(56)

References Cited

U.S. PATENT DOCUMENTS

D275,223 S 8/1984 Marxen
 4,945,929 A 8/1990 Egilmex
 5,042,510 A 8/1991 Curtiss et al.
 5,095,921 A 3/1992 Losee et al.
 5,179,966 A 1/1993 Losee et al.
 5,269,327 A 12/1993 Counts et al.
 D347,490 S 5/1994 Gee et al.
 D375,159 S 10/1996 Johansson
 D384,283 S 9/1997 Davies et al.
 D404,459 S 1/1999 Fumer et al.
 D404,629 S 1/1999 Cooper
 D405,220 S 2/1999 Dal Monte
 6,061,950 A 5/2000 Carey et al.
 6,231,336 B1 5/2001 Chen
 6,357,448 B1 3/2002 Sinclair, Jr.
 6,649,268 B1 11/2003 Komine et al.
 D484,963 S 1/2004 Jones et al.
 D489,679 S 5/2004 Wong
 D497,423 S 10/2004 Muir et al.
 D508,199 S 8/2005 Winig et al.
 D534,682 S 1/2007 Malhi
 D548,086 S 8/2007 Conway et al.
 D550,378 S 9/2007 Adams et al.
 D550,829 S 9/2007 Buthier et al.
 D555,085 S 11/2007 Kim
 D591,415 S 4/2009 Wu
 D633,034 S 2/2011 Heine et al.
 D641,464 S 7/2011 De Haan et al.
 D644,375 S 8/2011 Zhou
 8,002,897 B2 8/2011 Palfy et al.
 D646,431 S 10/2011 Awty et al.
 D651,338 S 12/2011 Awty et al.
 D662,257 S 6/2012 Alelov
 D684,311 S 6/2013 Liu
 D685,522 S 7/2013 Potter et al.
 D686,717 S 7/2013 Mack
 D688,415 S 8/2013 Kim
 D688,416 S 8/2013 Liu
 8,499,766 B1 8/2013 Newton
 D691,765 S 10/2013 Tucker et al.
 D691,766 S 10/2013 Tucker et al.
 D692,612 S 10/2013 Lowenthal et al.
 D692,613 S 10/2013 Morreale
 D694,468 S 11/2013 Chen
 D695,449 S 12/2013 Tucker et al.
 D702,478 S 4/2014 Wai
 8,707,965 B2 4/2014 Newton
 8,833,364 B2 9/2014 Buchberger
 8,881,737 B2 11/2014 Collett et al.
 8,888,311 B2 11/2014 Parsons
 8,897,628 B2 11/2014 Conley et al.
 D720,499 S 12/2014 Alima
 8,939,943 B2 1/2015 Edwards et al.
 D722,196 S 2/2015 Tucker et al.
 8,950,395 B2 2/2015 Schennum
 D724,262 S 3/2015 Hearn et al.
 D724,781 S 3/2015 Hearn et al.
 D725,821 S 3/2015 Levin et al.
 D727,564 S 4/2015 LaForge et al.
 D727,565 S 4/2015 LaForge et al.
 D728,154 S 4/2015 Lavanchy et al.
 D729,439 S 5/2015 Scatterday
 D730,571 S 5/2015 Chen
 9,050,427 B2 6/2015 Harris et al.
 D738,567 S 9/2015 Tucker et al.
 D739,598 S 9/2015 Lavanchy et al.
 D742,021 S 10/2015 Labuschagne et al.
 D743,097 S 11/2015 Tucker et al.
 D743,622 S 11/2015 Alima
 D747,547 S 1/2016 Liu
 D748,323 S 1/2016 Tucker et al.
 D749,509 S 2/2016 Blau
 D750,834 S 3/2016 Wei
 D752,278 S * 3/2016 Verleur D13/103
 D754,916 S * 4/2016 Irvin D27/163

D754,919 S 4/2016 Alarcon et al.
 D755,440 S * 5/2016 Collen D27/163
 D756,031 S * 5/2016 Wu D27/101
 D756,564 S 5/2016 Yerkic-Husejnovic et al.
 D757,352 S * 5/2016 Bagai D27/101
 D760,948 S * 7/2016 Eksouzian D27/101
 D761,998 S * 7/2016 Pinder D27/101
 D773,729 S * 12/2016 Jordan D27/194
 D774,248 S * 12/2016 Jordan D27/194
 D776,337 S * 1/2017 Levin D27/101
 2012/0053512 A1 3/2012 Muse
 2013/0068239 A1 3/2013 Youn
 2013/0087160 A1 4/2013 Gherghe
 2013/0140200 A1 6/2013 Scatterday
 2013/0167854 A1 7/2013 Shin
 2013/0192615 A1 8/2013 Tucker et al.
 2013/0192623 A1 8/2013 Tucker et al.
 2013/0213419 A1 8/2013 Tucker et al.
 2013/0228190 A1 9/2013 Weiss et al.
 2013/0298905 A1 11/2013 Levin et al.
 2013/0312742 A1 11/2013 Monsees et al.
 2013/0319440 A1 12/2013 Capuano
 2013/0327345 A1 12/2013 Clarke
 2013/0340775 A1 12/2013 Juster et al.
 2014/0014124 A1 1/2014 Glasberg et al.
 2014/0020693 A1 1/2014 Cochand et al.
 2014/0034070 A1 2/2014 Schennum
 2014/0053856 A1 2/2014 Liu
 2014/0060554 A1 3/2014 Collett et al.
 2014/0076310 A1 3/2014 Newton
 2014/0174458 A1 6/2014 Katz
 2014/0202477 A1 7/2014 Qi et al.
 2014/0209105 A1 7/2014 Sears et al.
 2014/0224267 A1 8/2014 Levitz et al.
 2014/0270727 A1 9/2014 Ampolini et al.
 2014/0283859 A1 9/2014 Minskoff et al.
 2014/0318558 A1 10/2014 Liu
 2014/0336565 A1 11/2014 Nichols
 2014/0345632 A1 11/2014 Scatterday
 2014/0345635 A1 11/2014 Rabinowitz et al.
 2014/0355969 A1 12/2014 Stern
 2014/0360516 A1 12/2014 Liu
 2015/0020827 A1 1/2015 Liu
 2015/0020828 A1 1/2015 Liu
 2015/0027470 A1 1/2015 Kane et al.
 2015/0059784 A1 3/2015 Liu
 2015/0144148 A1 5/2015 Chen
 2015/0150307 A1 6/2015 Liu
 2015/0196059 A1 7/2015 Liu
 2015/0208726 A1 7/2015 Liu
 2015/0245657 A1 9/2015 Memari et al.
 2015/0296889 A1 10/2015 Liu
 2015/0328415 A1 11/2015 Minskoff et al.
 2015/0332379 A1 11/2015 Alarcon
 2016/0150823 A1 6/2016 Liu
 2016/0374395 A1 * 12/2016 Jordan A24F 47/008
 131/329
 2016/0374396 A1 * 12/2016 Jordan A24F 47/008
 392/386
 2016/0374397 A1 * 12/2016 Jordan A24F 47/008
 131/329

OTHER PUBLICATIONS

<<http://kelvin.en.made-in-china.com/productimage/FghEJNdCeOVw-2flj00KeBtCALgEjYE/China-High-Quality-Triangular-Trimark-E-Cigarette.html>>, copyright 2015, Focus Technology Co., Ltd.
 "Smokio: Smart Wireless E-cigarette," <http://www.premiumlifestyle.co.uk/products/smokio-smart-wireless-e-cigarette>.
 About Electronic Cigarettes/Vapor Cigarettes/E-cigs, <https://www.vapinapes.com/about-vapor-cigarettes/>.
 Supersmoke: The Latest Supersmoker Bluetooth, <http://www.supersmokerbluetooth.com/>.
 Kosmo, <https://www.indiegogo.com/projects/kosmo-ecigarette>.

(56)

References Cited

OTHER PUBLICATIONS

Mouthpiece of Smoking Article | Nicotek 3pk Cartridge | Metro, postdate N/A, @ 2015 metroecigs.com, [online], [site visited Nov. 24, 2015], Available from Internet, <http://www.metroecigs.com/product/metromentholnonicotinecartridges.asp>.

Mouthpiece of Smoking Article | V2 Cigs Blu | Ecigarette Reviewed | postdate Mar. 24, 2014 © 2015 ecigarettereviewed.com, [online], [site visited Nov. 24, 2015] Available from Internet, <http://ecigarettereviewed.com/blu-cigs-review/>.

Notice of Allowance for corresponding U.S. Appl. No. 29/531/410 dated Mar. 25, 2016.

Notice of Allowance for corresponding U.S. Appl. No. 29/527,151 dated Mar. 30, 2016.

Non-Final Office Action for corresponding U.S. Appl. No. 29/527,153 dated Mar. 28, 2016.

Notice of Allowance for corresponding U.S. Appl. No. 29/527,149 dated Apr. 11, 2016.

Notice of Allowance for corresponding U.S. Appl. No. 29/531,427 dated Apr. 5, 2016.

Notice of Allowance for corresponding U.S. Appl. No. 29/531,410 dated May 26, 2016.

Notice of Allowance for corresponding U.S. Appl. No. 29/527,149 dated Jun. 8, 2016.

Notice of Allowance for corresponding U.S. Appl. No. 29/527,151 dated May 25, 2016.

* cited by examiner

FIG. 1

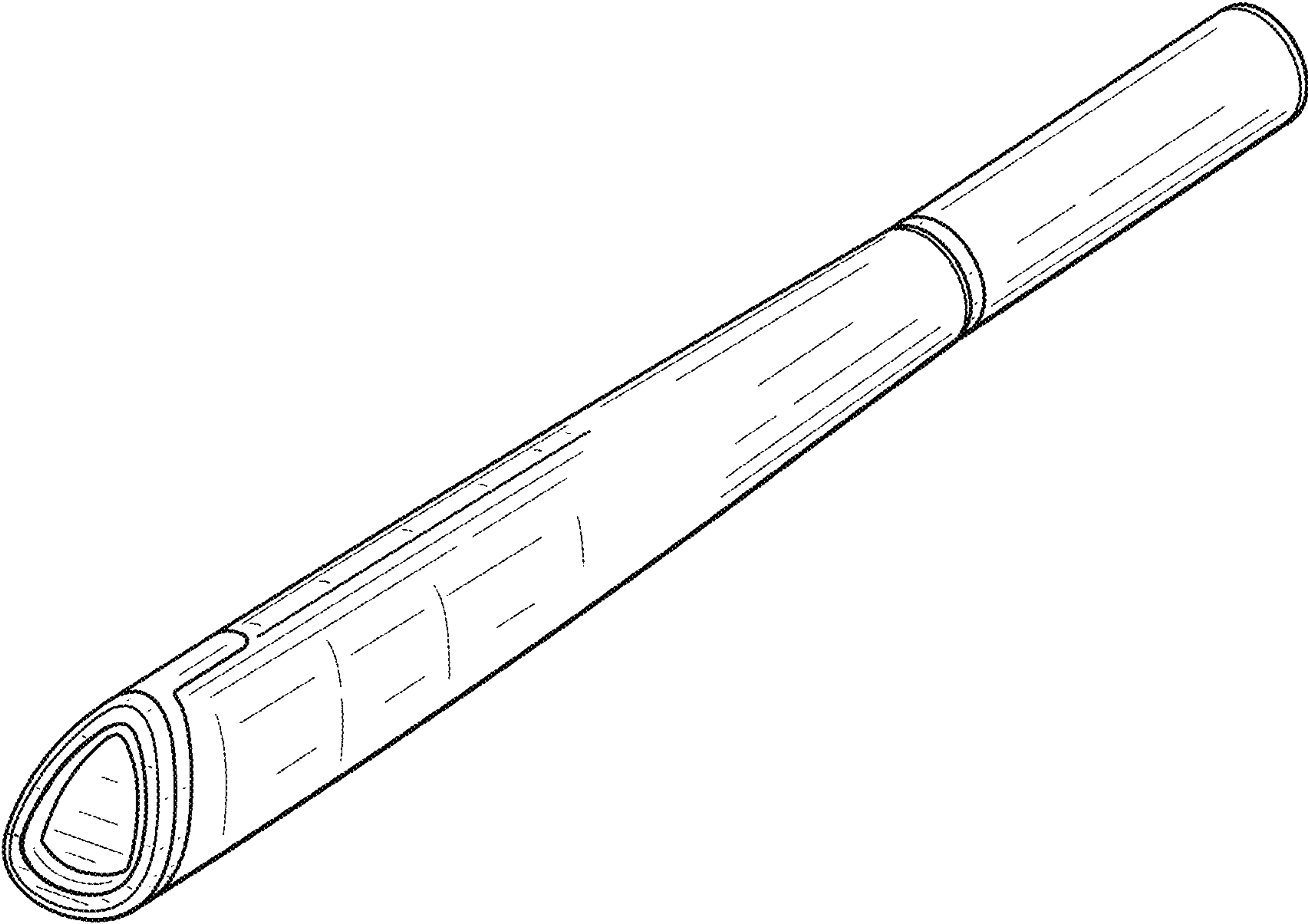

FIG. 2

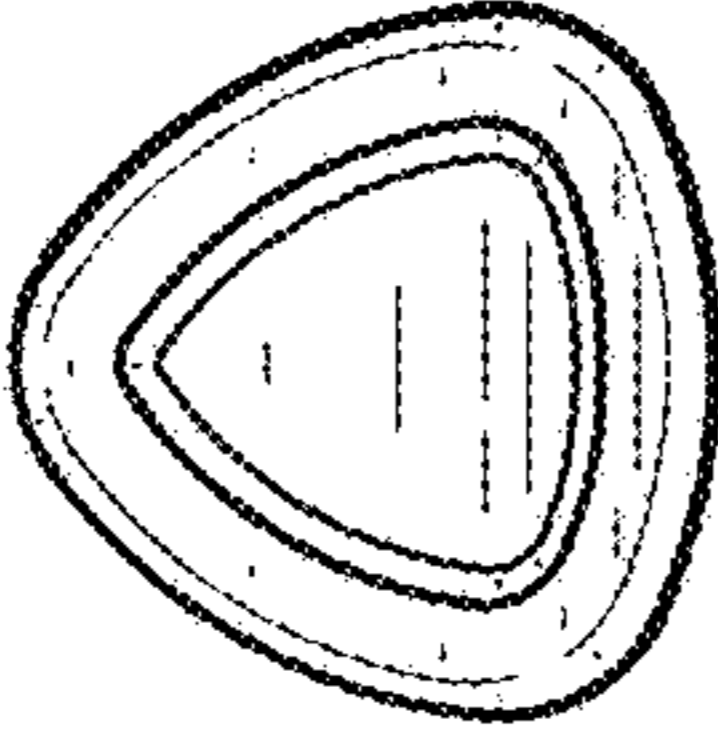

FIG. 3

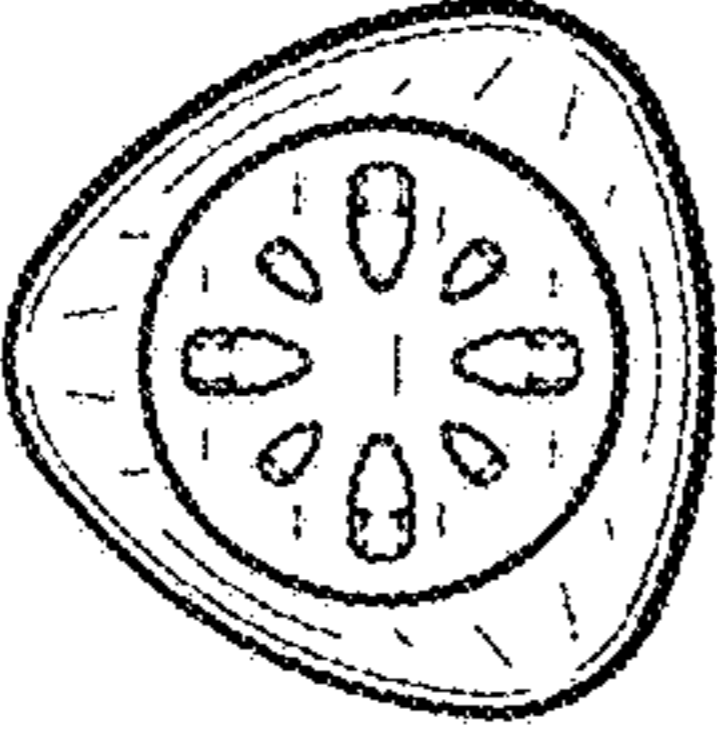

FIG. 4

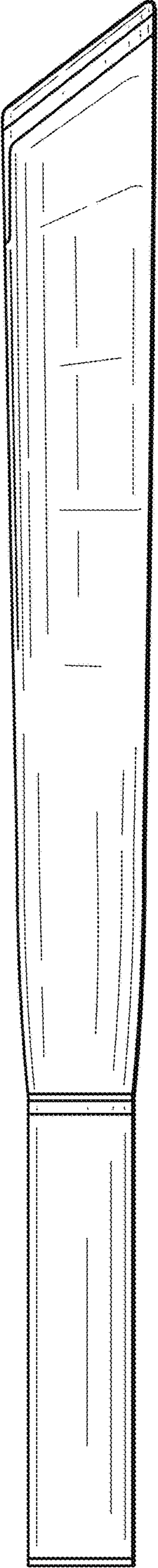

FIG. 5

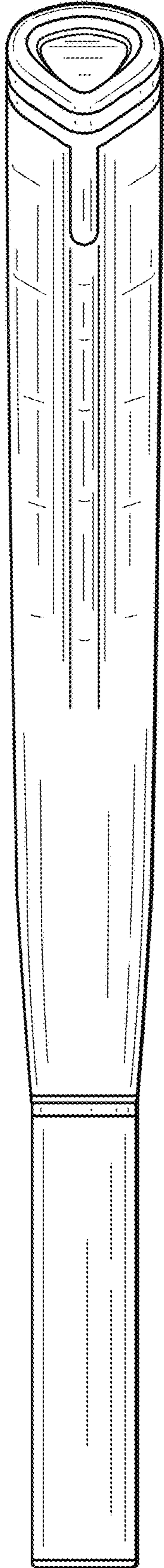

FIG. 6

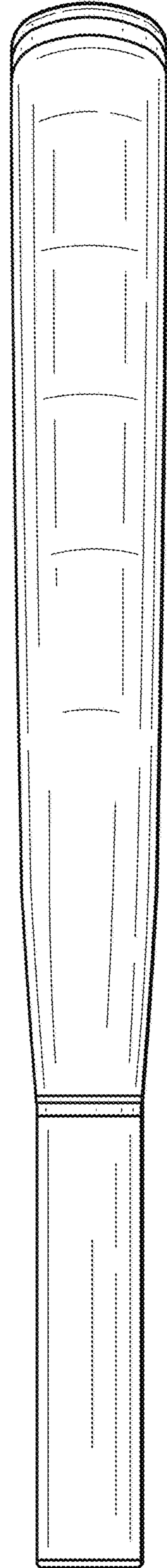

FIG. 7

