

US00D792643S

(12) **United States Design Patent** (10) **Patent No.:** **US D792,643 S**
Wong et al. (45) **Date of Patent:** **** Jul. 18, 2017**

(54) **ELECTRONIC CIGARETTE**
(71) Applicants: **Tan Wong**, Shanghai (CN); **Yanming Nie**, Shanghai (CN)
(72) Inventors: **Tan Wong**, Shanghai (CN); **Yanming Nie**, Shanghai (CN)
(73) Assignee: **SHANGHAI GREEN VAPER TECHNOLOGY CO., LTD.** (CN)
(**) Term: **15 Years**
(21) Appl. No.: **29/547,593**
(22) Filed: **Dec. 4, 2015**
(51) **LOC (10) Cl.** **27-01**
(52) **U.S. Cl.**
USPC **D27/101**
(58) **Field of Classification Search**
USPC D27/101, 100, 163-172
CPC A24F 47/00; A24F 47/002; A24F 47/004;
A24F 47/006; A24F 47/008
See application file for complete search history.

(56) **References Cited**
U.S. PATENT DOCUMENTS
D479,018 S * 8/2003 Sgariboldi D28/85
D615,699 S * 5/2010 Vordenberg D27/102
D656,545 S * 3/2012 Hung D19/117

D675,777 S * 2/2013 Wu D27/101
D681,038 S * 4/2013 Tomohiro D14/411
D720,882 S * 1/2015 Albanese D27/101
D773,727 S * 12/2016 Eksouzian D27/101
D776,337 S * 1/2017 Levin D27/101
D779,719 S * 2/2017 Qiu D27/101
2015/0150305 A1* 6/2015 Shenkal A24F 47/008
131/329
2016/0345626 A1* 12/2016 Wong A24F 47/008

* cited by examiner
Primary Examiner — Susan Bennett Hattan
Assistant Examiner — Jennifer Wright
(74) *Attorney, Agent, or Firm* — Clement Cheng

(57) **CLAIM**
The ornamental design for an electronic cigarette, as shown and described.

DESCRIPTION
FIG. 1 is a perspective view.
bFIG. 2 is a front view.
FIG. 3 is a rear view.
FIG. 4 is a left side view.
FIG. 5 is a right side view.
FIG. 6 is a top view; and,
FIG. 7 is a bottom view.
The broken lines in FIG. 3 depict parts of the electronic cigarette that form no part of the claimed design.

1 Claim, 3 Drawing Sheets

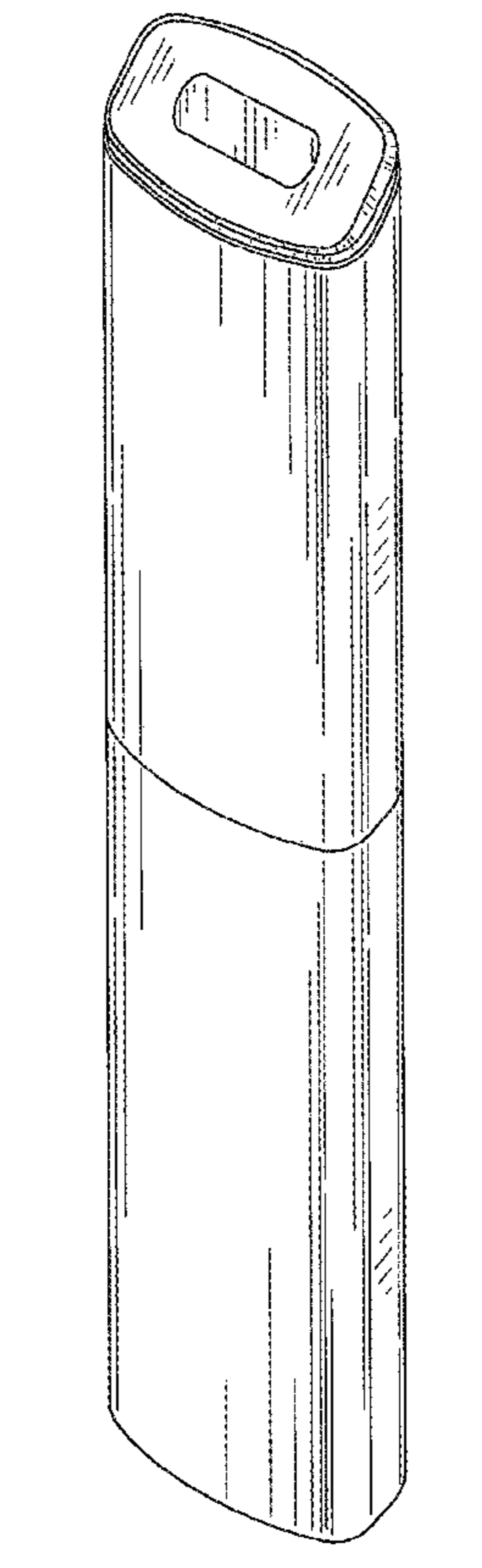

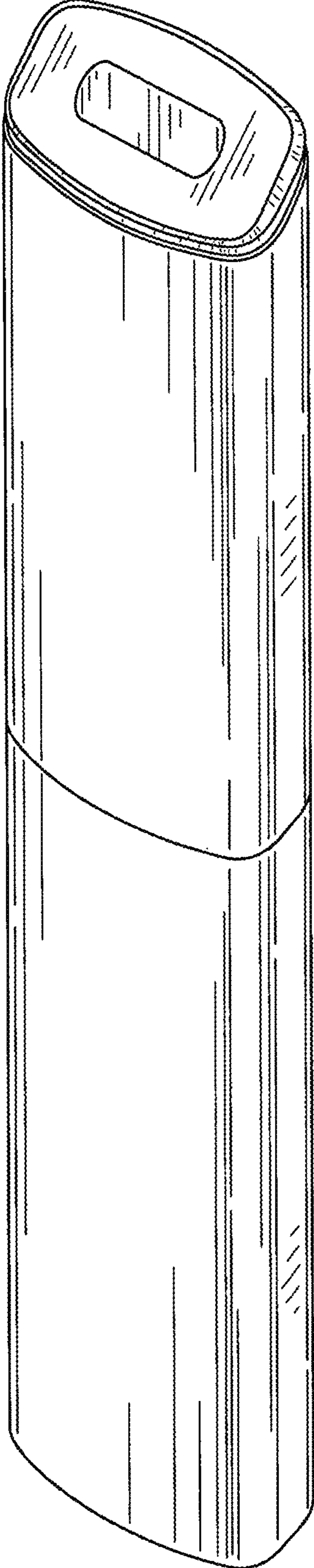

FIG. 1

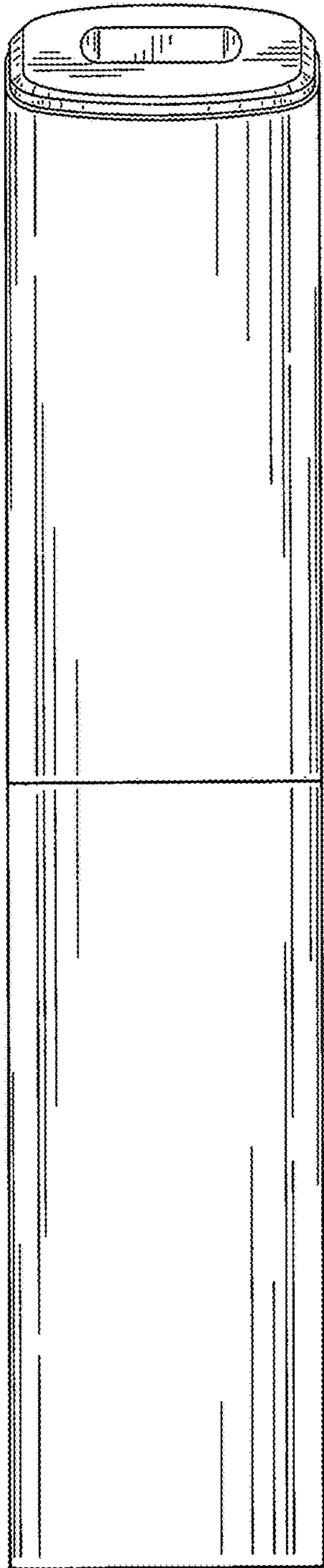

FIG. 2

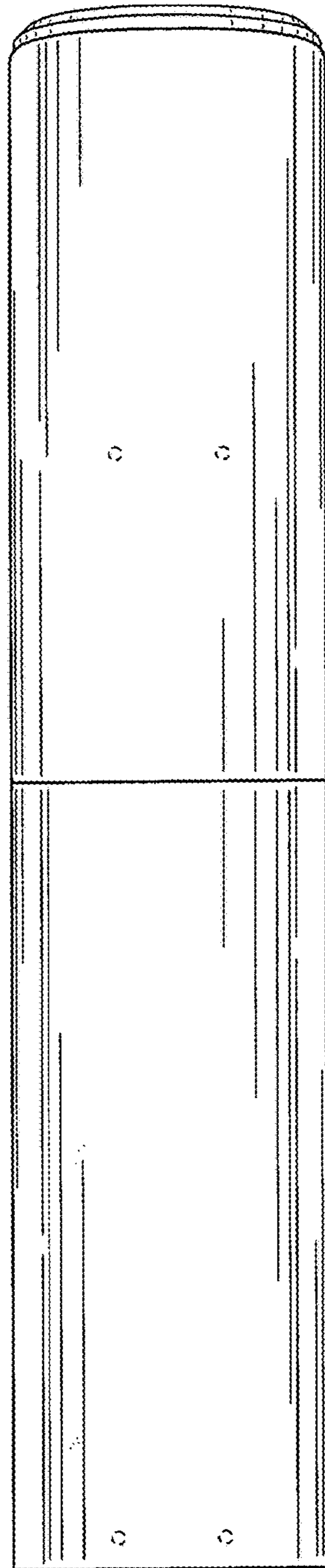

FIG. 3

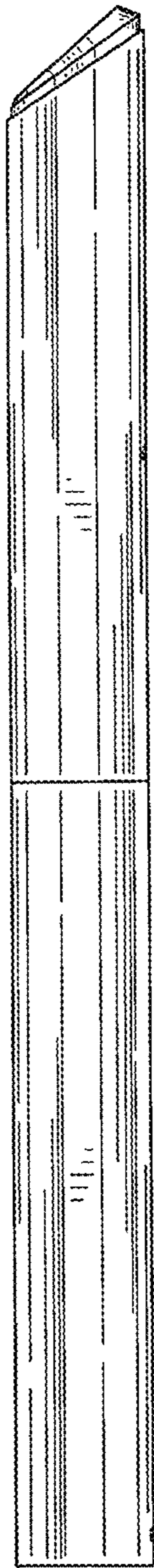

FIG. 4

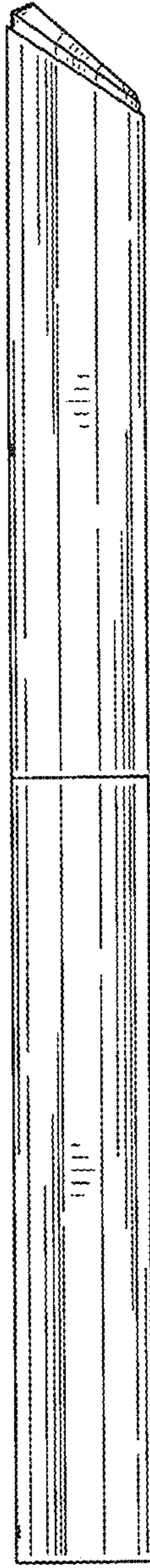

FIG. 5

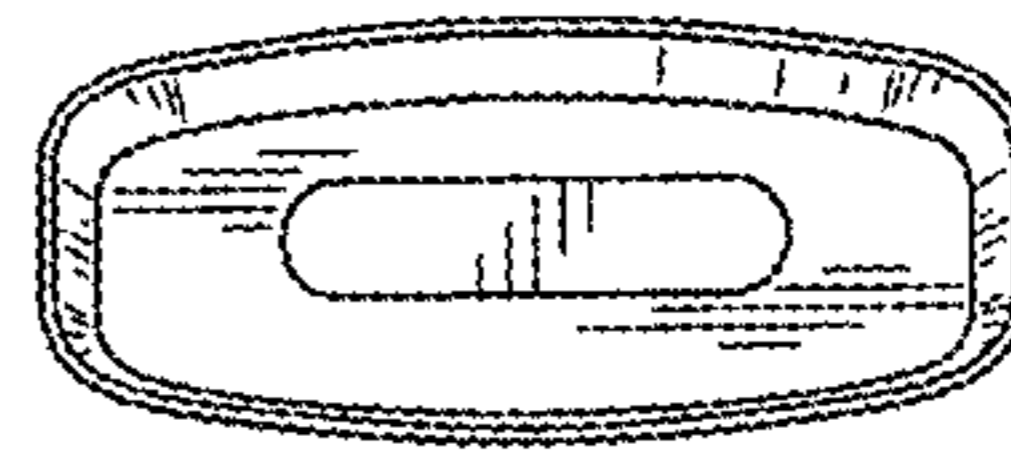

FIG. 6

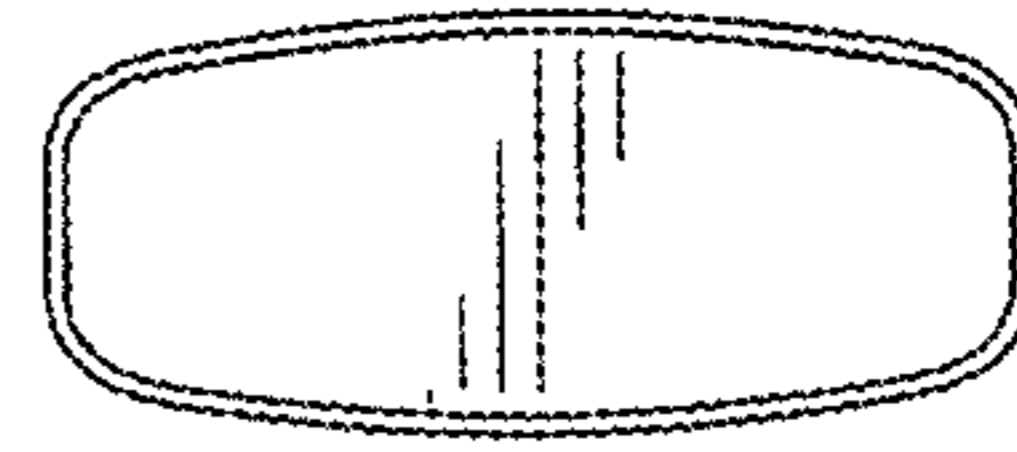

FIG. 7