



US00D792618S

(12) **United States Design Patent**  
**Wu**

(10) **Patent No.:** **US D792,618 S**  
(45) **Date of Patent:** **\*\* Jul. 18, 2017**

(54) **VEHICLE TAILLIGHT**

(71) Applicant: **COPLUS INC.**, Tainan (TW)

(72) Inventor: **Po-Hua Wu**, Tainan (TW)

(73) Assignee: **Coplus Inc.**, Tainan (TW)

(\*\*) Term: **15 Years**

(21) Appl. No.: **29/558,165**

(22) Filed: **Mar. 15, 2016**

(30) **Foreign Application Priority Data**

Sep. 23, 2015 (TW) ..... 104305301

(51) **LOC (10) Cl.** ..... **26-06**

(52) **U.S. Cl.**  
USPC ..... **D26/28**

(58) **Field of Classification Search**

USPC ..... D26/28-36; 362/80-83, 267-269,  
362/459-468, 475-478, 485-487

CPC ..... F21S 48/00; F21S 48/10; F21S 48/115;  
F21S 48/1233; F21S 48/1266; F21S  
48/1388; F21S 48/2268; F21V 21/04

See application file for complete search history.

(56) **References Cited**

**U.S. PATENT DOCUMENTS**

D586,020 S \* 2/2009 Hsu ..... D26/28  
D586,023 S \* 2/2009 Hsu ..... D26/28

D674,939 S \* 1/2013 Lai ..... D26/28  
D705,962 S \* 5/2014 Hildebrand ..... D26/28  
D708,770 S \* 7/2014 Lai ..... D26/28  
D714,982 S \* 10/2014 Lai ..... D26/28

\* cited by examiner

*Primary Examiner* — Marcus Jackson

(74) *Attorney, Agent, or Firm* — Lewis Roca Rothgerber  
Christie LLP

(57) **CLAIM**

The ornamental design for a vehicle taillight, as shown and described.

**DESCRIPTION**

FIG. 1 is a perspective view of the vehicle taillight;  
FIG. 2 is a front view thereof;  
FIG. 3 is a rear view thereof;  
FIG. 4 is a left side view thereof;  
FIG. 5 is a right side view thereof;  
FIG. 6 is a top view thereof; and,  
FIG. 7 is a bottom view thereof.

The broken lines in the drawings are for illustrative purpose only and form no part of the claimed design.

**1 Claim, 5 Drawing Sheets**

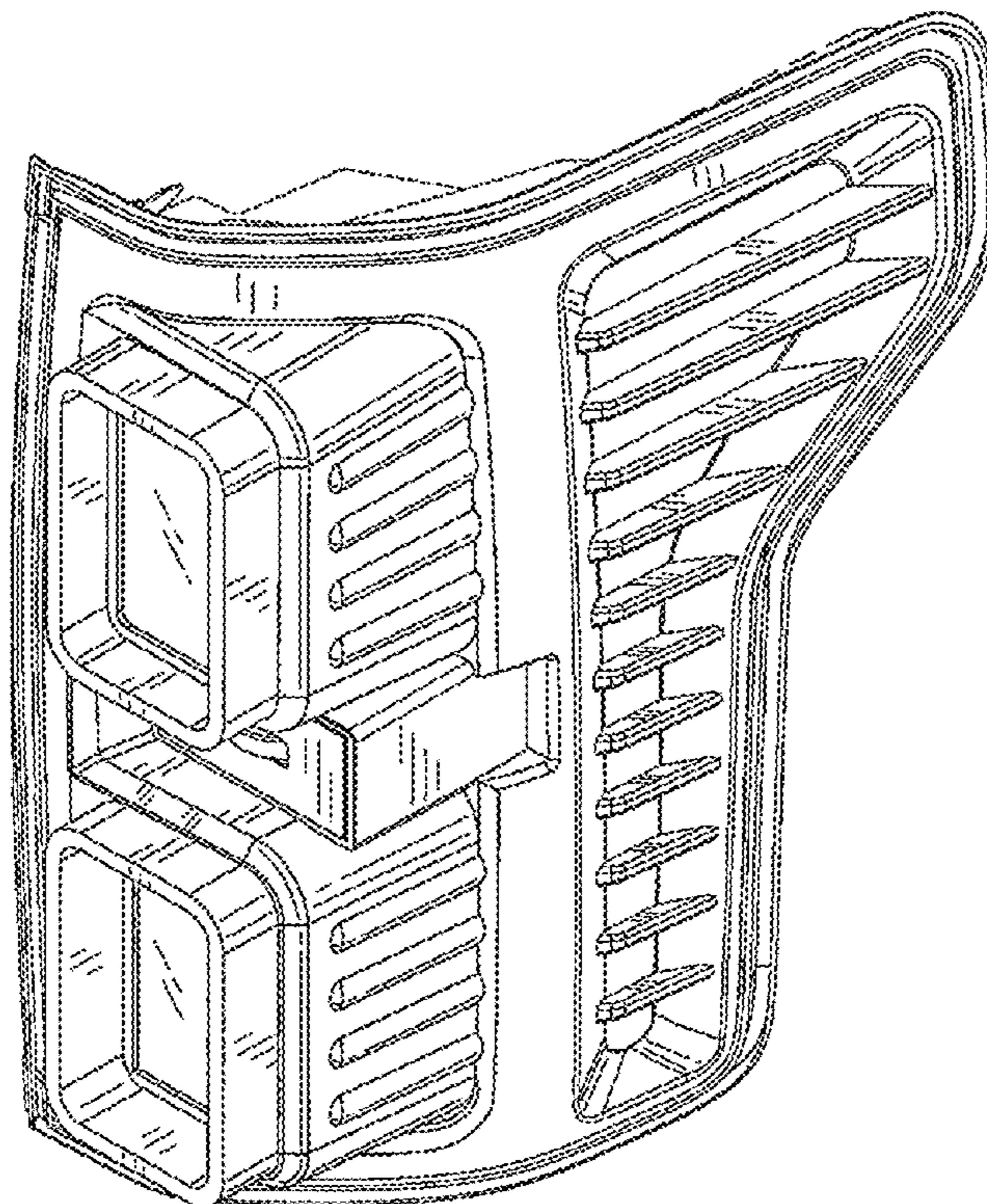

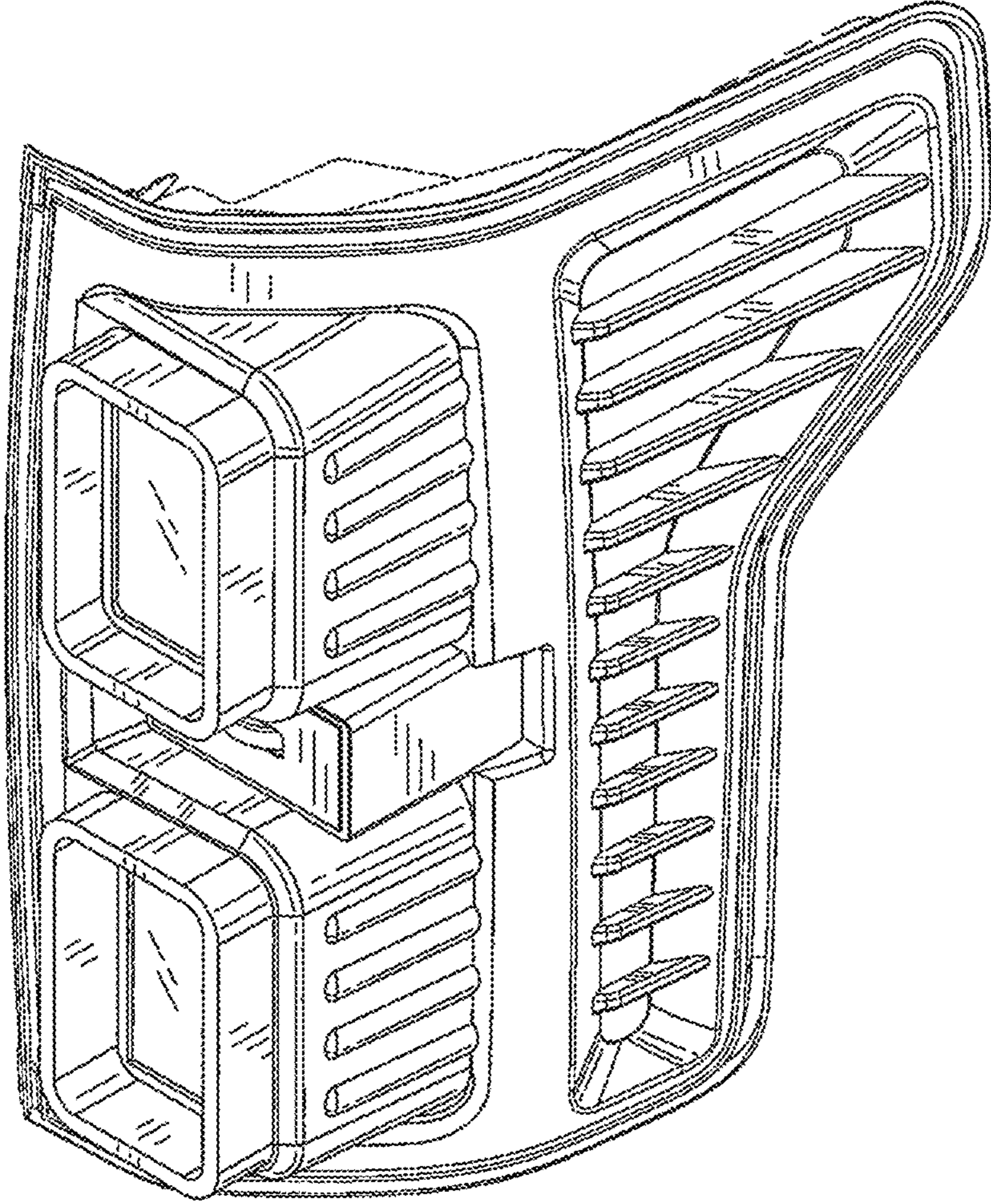

FIG. 1

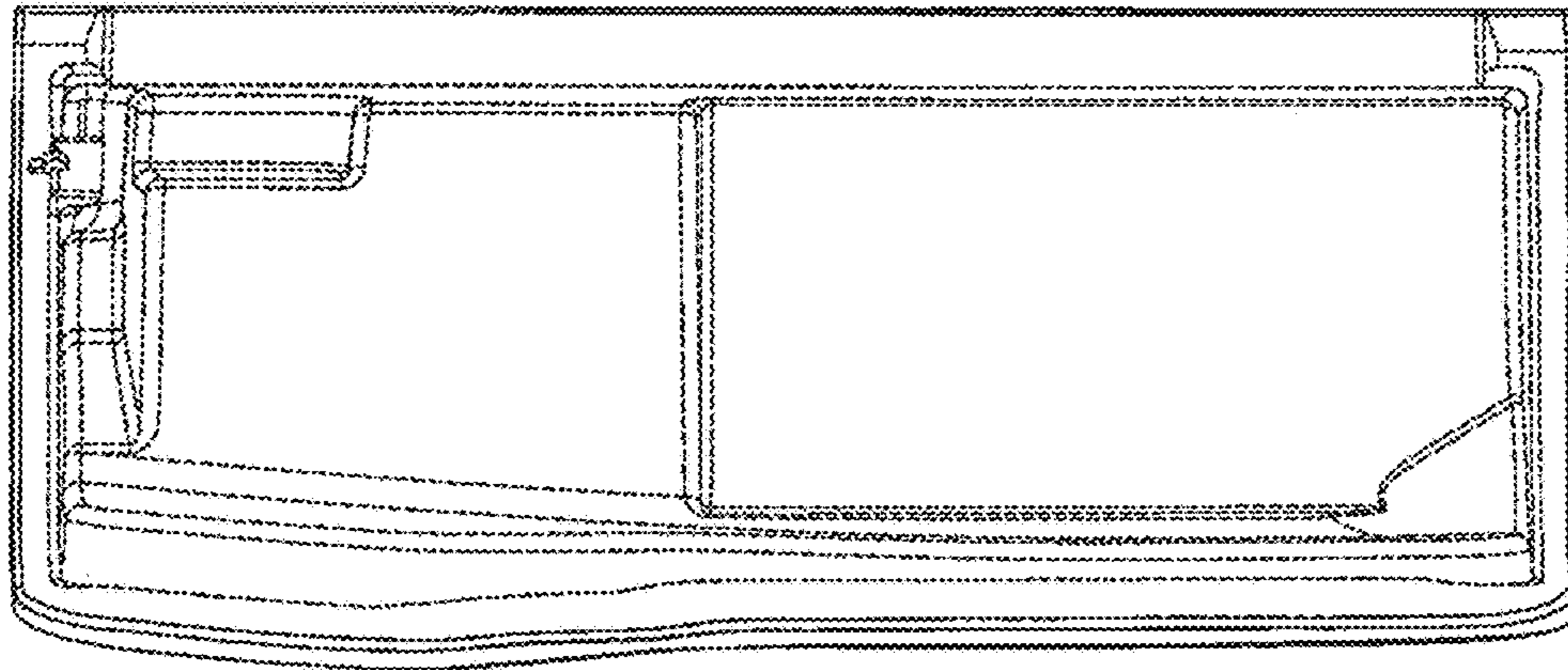

FIG. 3

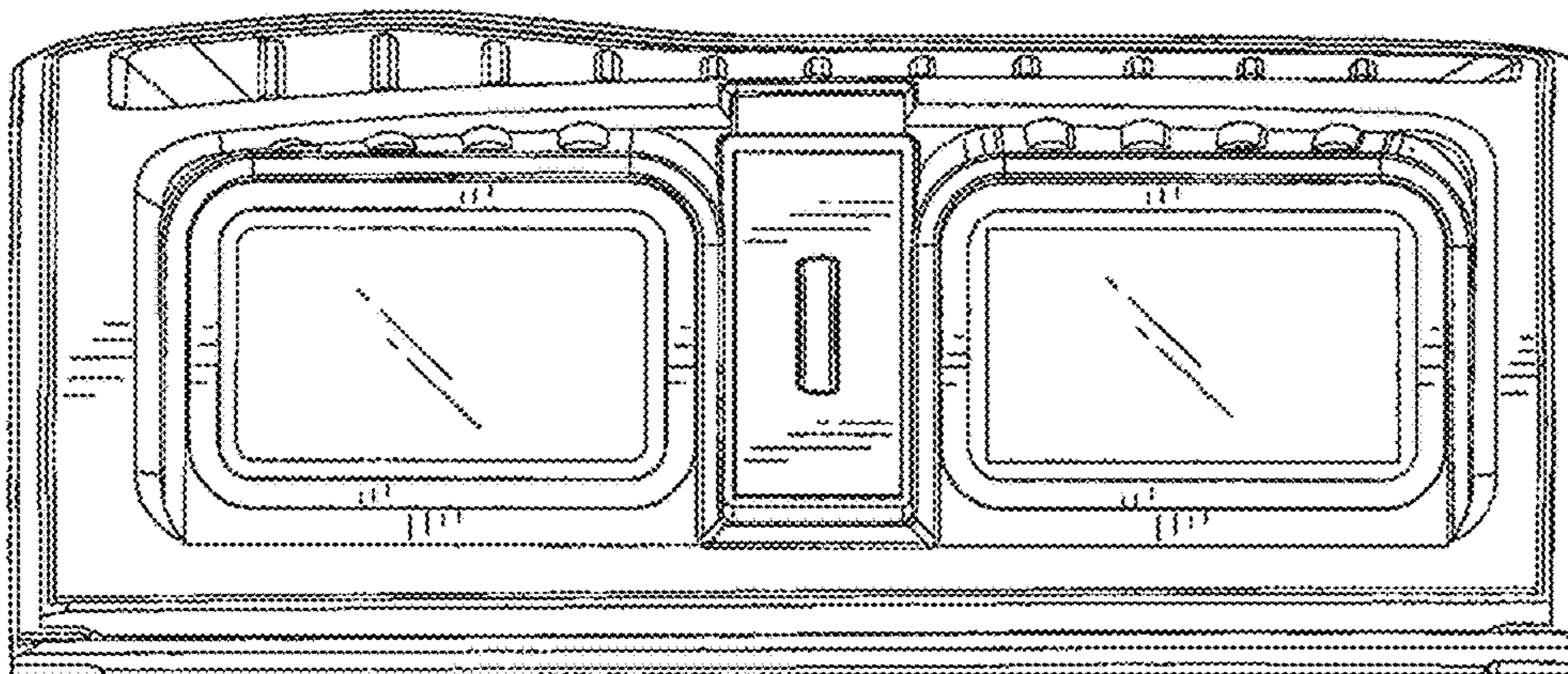

FIG. 2

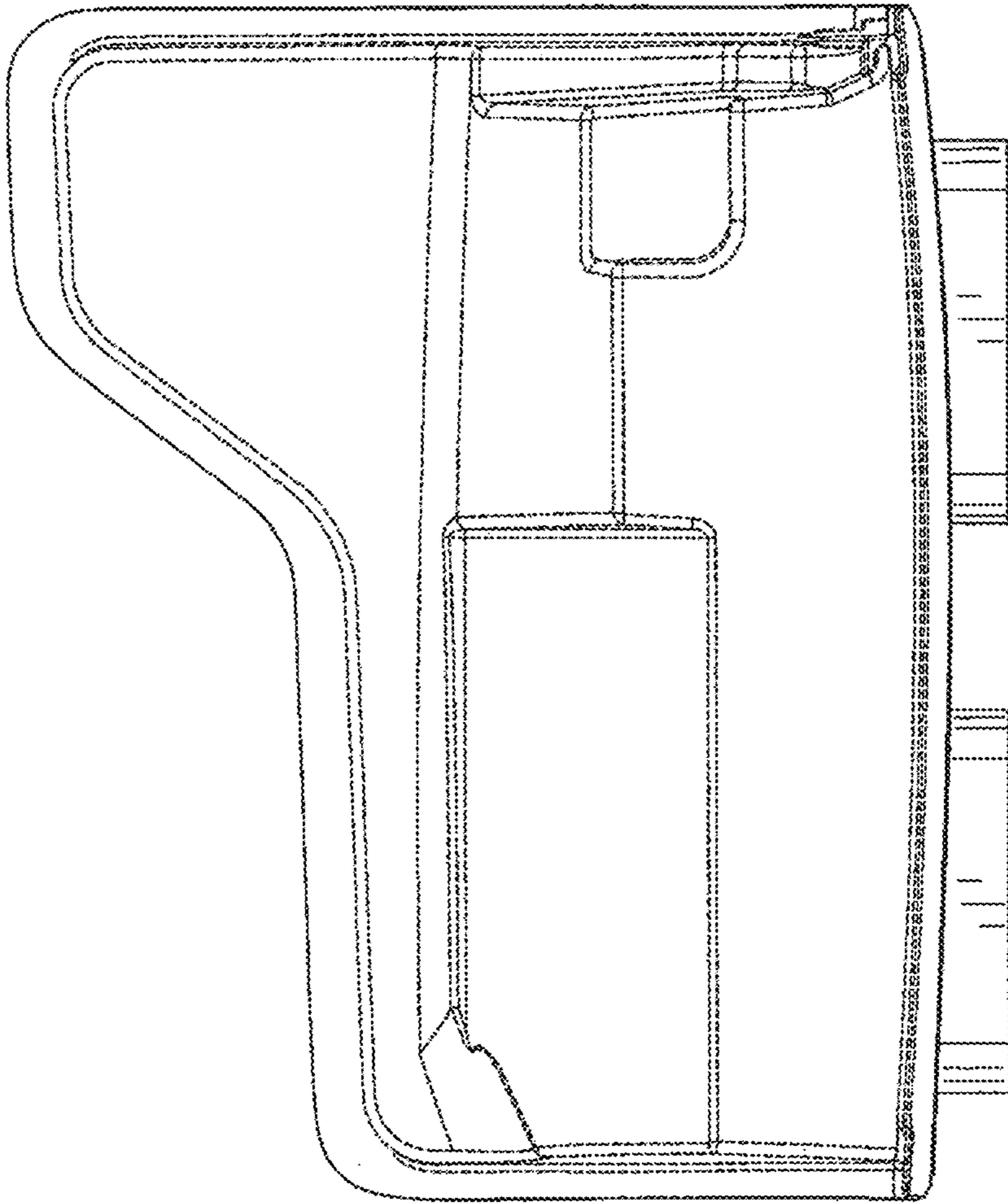

FIG. 4

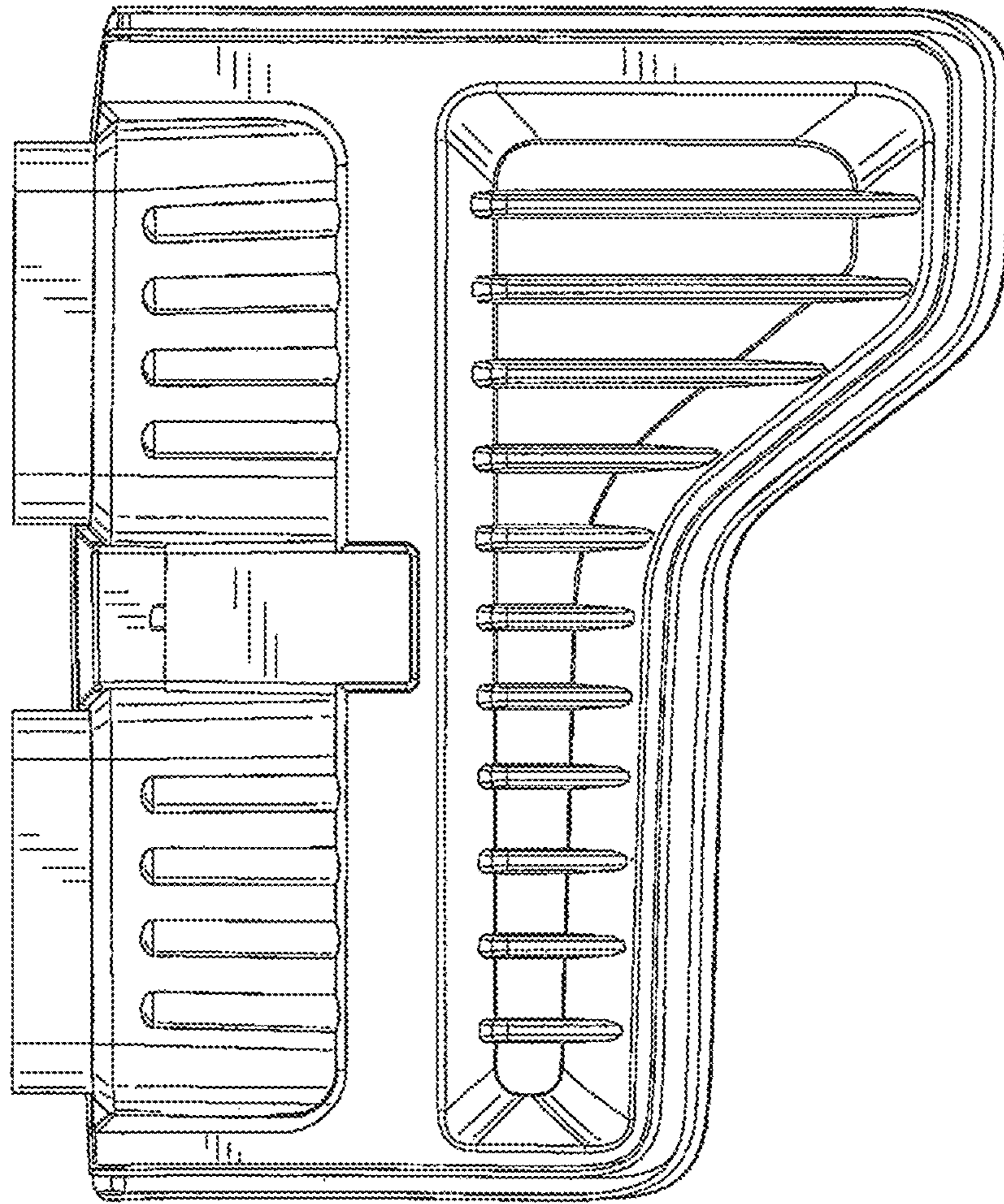

FIG. 5

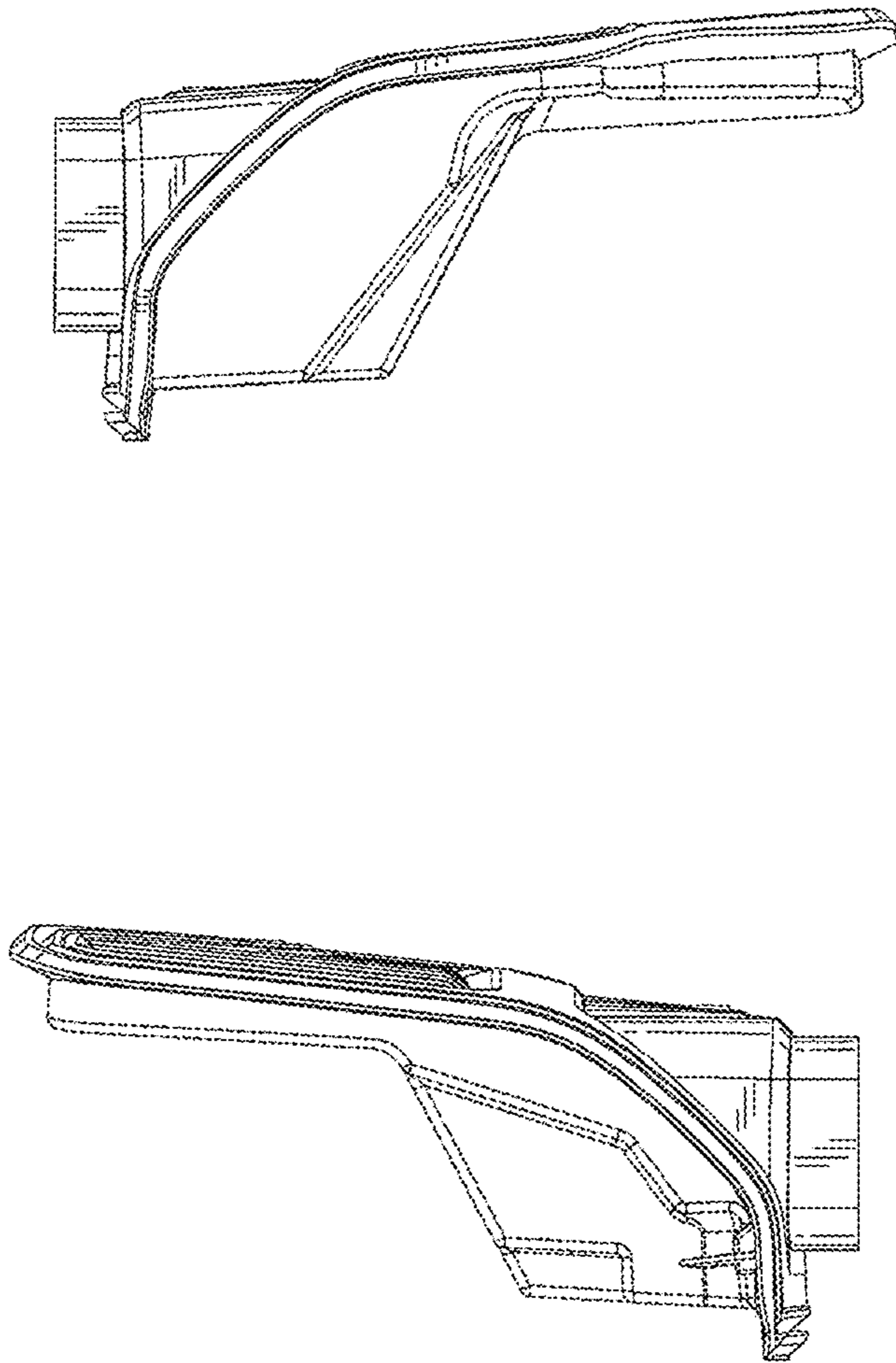

FIG. 7

FIG. 6