



US00D792496S

(12) **United States Design Patent** (10) **Patent No.:** **US D792,496 S**  
**Meyer et al.** (45) **Date of Patent:** **\*\* Jul. 18, 2017**

(54) **CAMERA**  
(71) Applicant: **Nokia Technologies Oy**, Espoo (FI)  
(72) Inventors: **Axel Meyer**, Millbrae, CA (US);  
**Alejandro Sanguinetti**, Helsinki (FI)  
(73) Assignee: **Nokia Technologies Oy**, Espoo (FI)  
(\*\*) Term: **15 Years**

D745,076 S \* 12/2015 Pfeil ..... D16/207  
D747,390 S \* 1/2016 Roth ..... D16/218  
D749,161 S \* 2/2016 Scalisi ..... D16/203  
D761,342 S \* 7/2016 Kim ..... D16/203  
D768,223 S \* 10/2016 Wu ..... D16/203  
2013/0258102 A1\* 10/2013 Chen ..... G03B 17/02  
348/143  
2015/0077555 A1\* 3/2015 Scalisi ..... H04N 5/23206  
348/143

(21) Appl. No.: **29/544,020**  
(22) Filed: **Oct. 29, 2015**  
(30) **Foreign Application Priority Data**

Apr. 29, 2015 (EM) ..... 002692145

(51) **LOC (10) Cl.** ..... **16-01**  
(52) **U.S. Cl.**  
USPC ..... **D16/207**; D16/218

(58) **Field of Classification Search**  
USPC ..... D16/200–208, 210, 214, 218, 219, 242;  
D26/1–3; 348/373–376; 396/419, 427,  
396/535–541  
CPC ..... G03B 15/03; G03B 17/02; G03B 17/04;  
G03B 17/56; G03B 19/04; H04N 5/2251;  
H04N 5/2252; H04N 5/2253; H04N  
5/2254; H04N 2101/00  
See application file for complete search history.

(56) **References Cited**  
U.S. PATENT DOCUMENTS

D435,577 S \* 12/2000 McBride ..... D16/203  
D487,939 S \* 3/2004 Smith ..... D26/2  
6,812,970 B1 \* 11/2004 McBride ..... G08B 13/19619  
348/151  
D673,988 S \* 1/2013 Riegl ..... D16/202  
D728,655 S \* 5/2015 Daniel ..... D16/203  
D740,873 S \* 10/2015 Scalisi ..... D16/203

**OTHER PUBLICATIONS**

Jedi Training Remote Movie Prop from the movie Star Wars (1977),  
Made by Master Replicas LLC, 1 color sheet; URL: <<http://www.entertainmentearth.com/prodinfo.asp?number=MRSW107>>; Date  
posting unknown but prior to the filing date of the present appli-  
cation.

(Continued)

*Primary Examiner* — Philip S Hyder  
*Assistant Examiner* — Ramzi Almatrahi  
(74) *Attorney, Agent, or Firm* — Banner & Witcoff, Ltd.

(57) **CLAIM**

The ornamental design for a camera, as shown and  
described.

**DESCRIPTION**

FIG. 1 is a perspective view of a camera showing our new  
design;  
FIG. 2 is a rear view thereof;  
FIG. 3 is a front view thereof;  
FIG. 4 is a right side view thereof;  
FIG. 5 is a left side view thereof;  
FIG. 6 is a top view thereof; and,  
FIG. 7 is a bottom view thereof.  
The broken line depict portions of the camera in which the  
design is embodied that form no part of the claimed design.

**1 Claim, 7 Drawing Sheets**

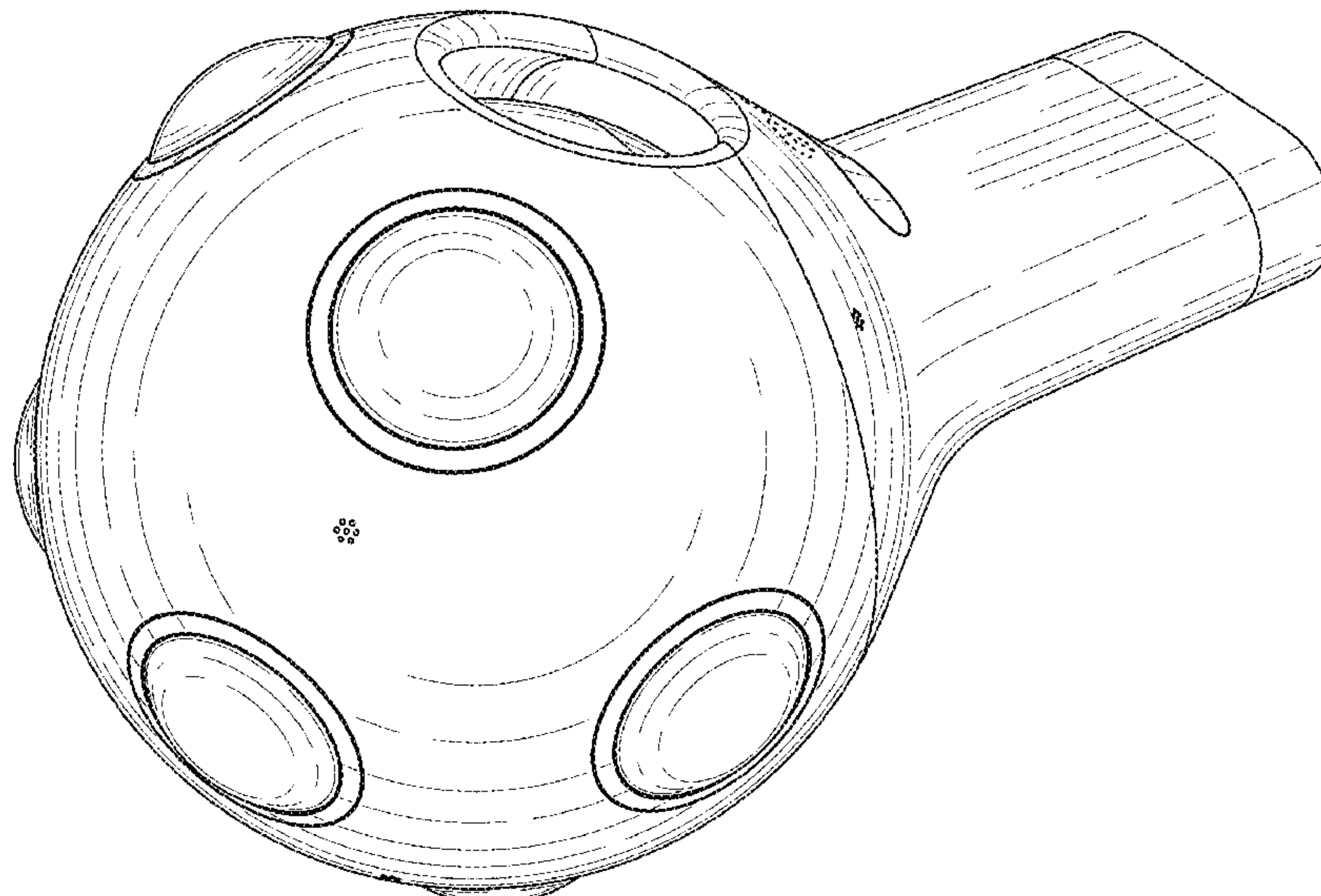

(56)

**References Cited**

OTHER PUBLICATIONS

Marksmen—H Combat Remote from the movie Star Wars (1977),  
1 color sheet; URL: <[http://starwars.wikia.com/wiki/Marksmen-  
H\\_combat\\_remote](http://starwars.wikia.com/wiki/Marksmen-H_combat_remote)>; Date of posting unknown but prior to the  
filing date of the present application.

\* cited by examiner

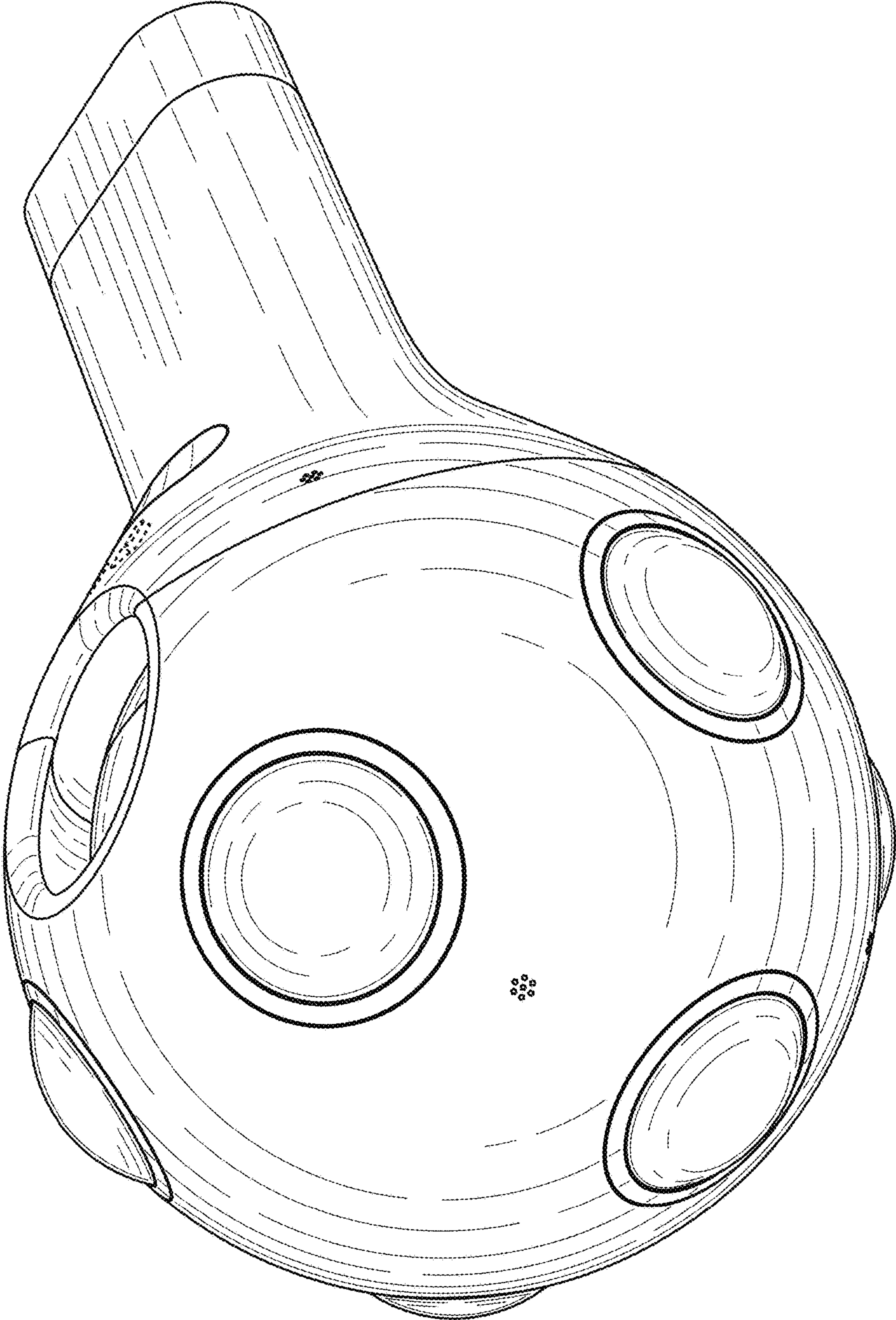

FIG. 1



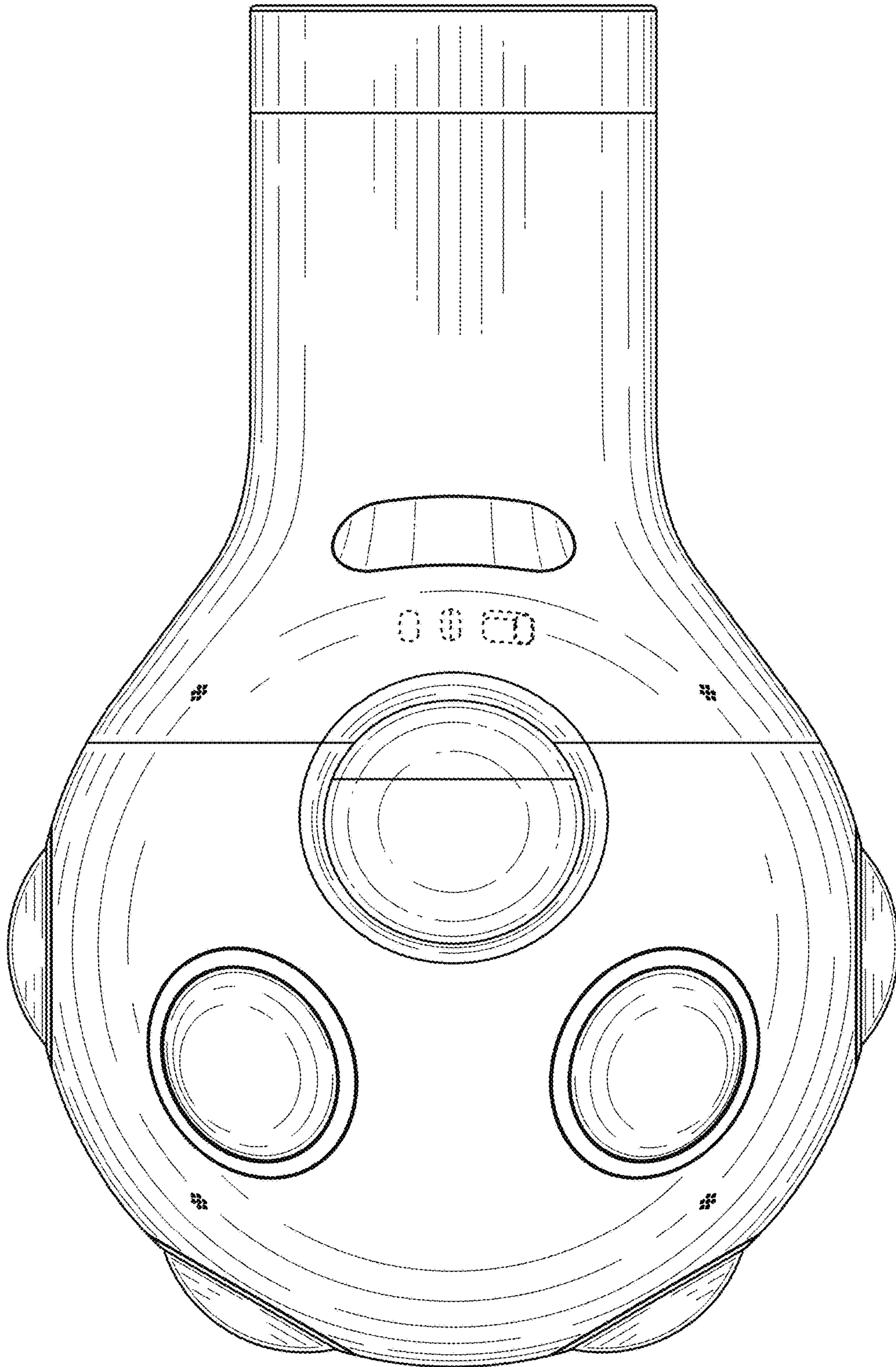

FIG. 2

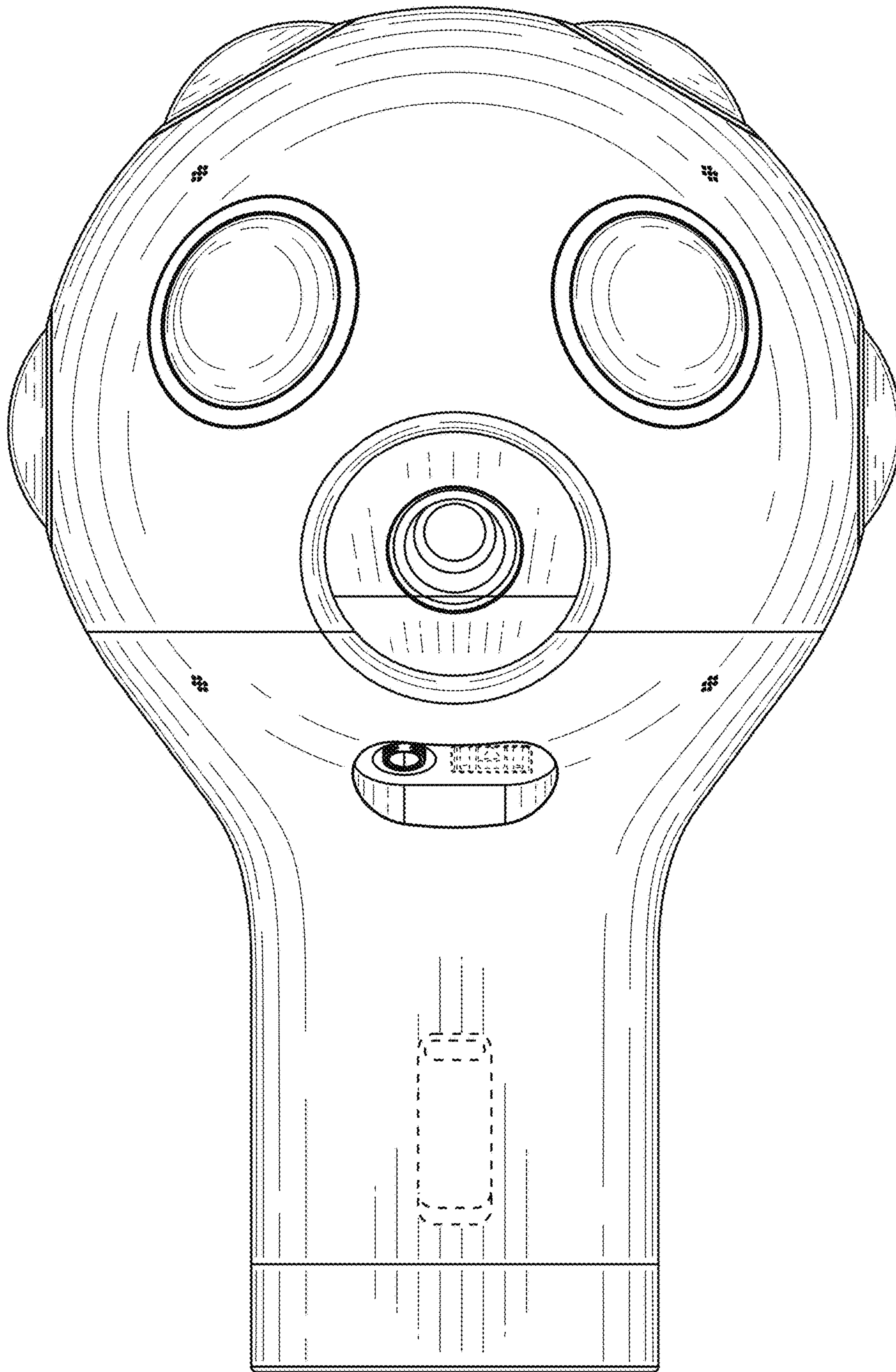

FIG. 3

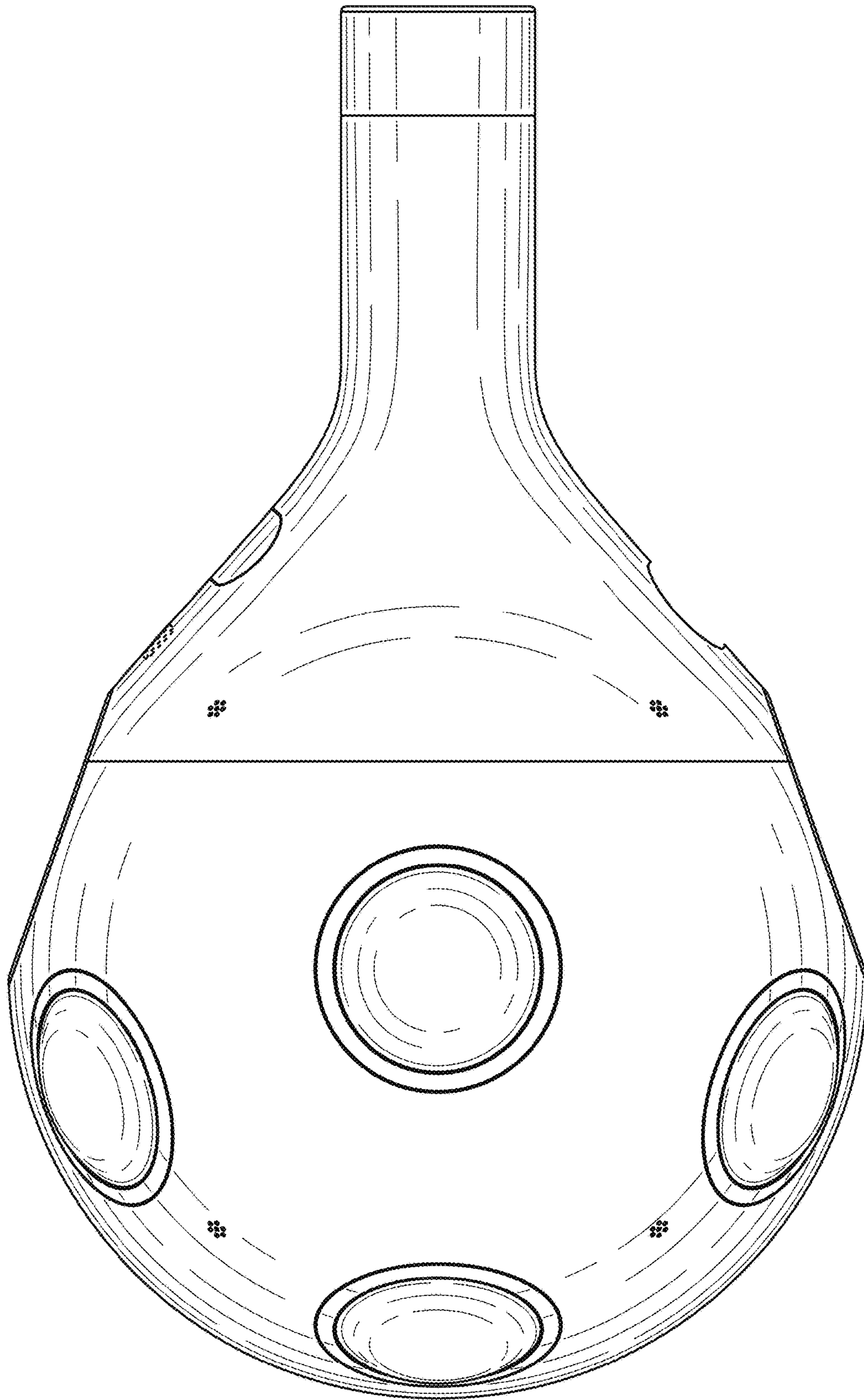

FIG. 4



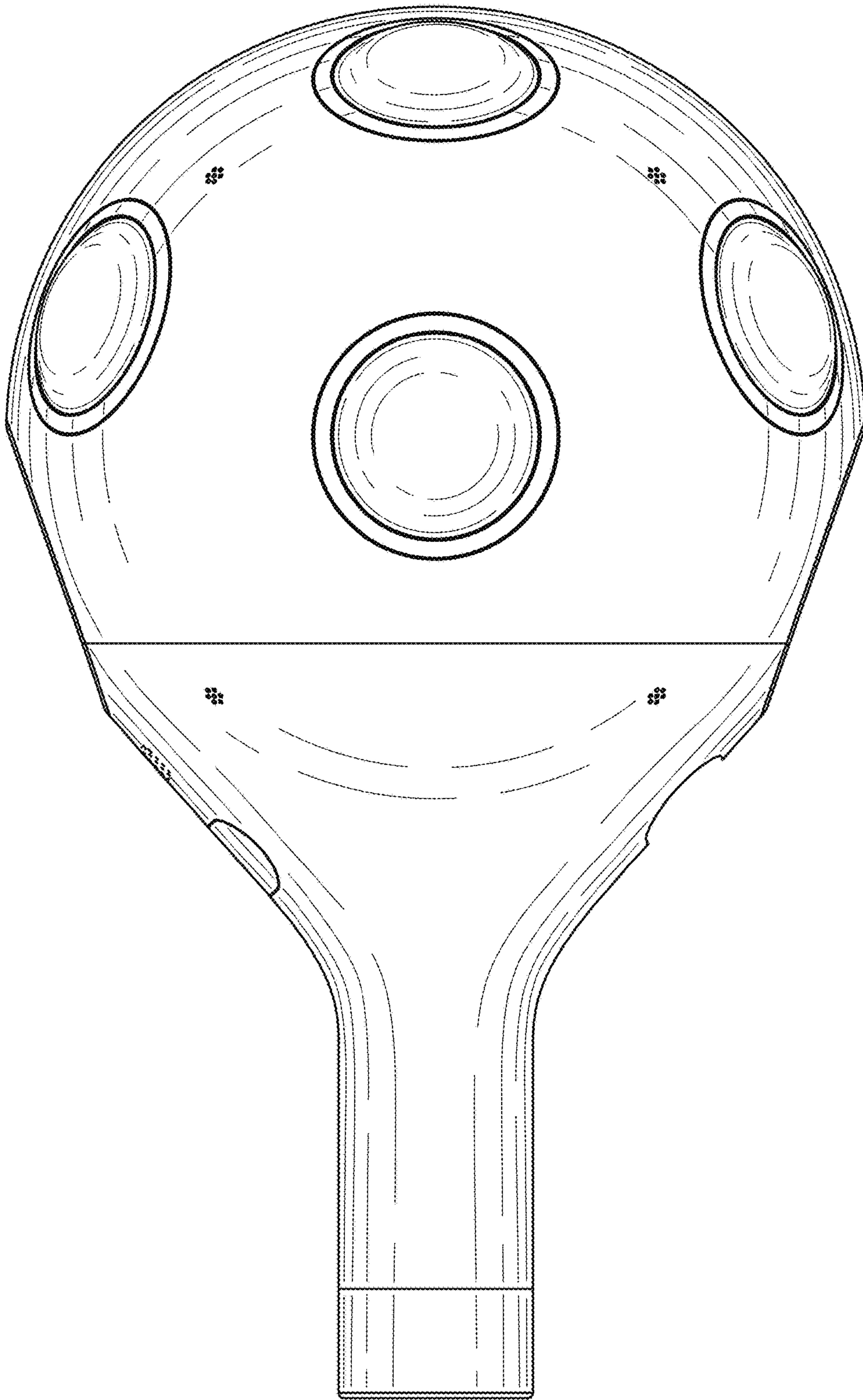

FIG. 5

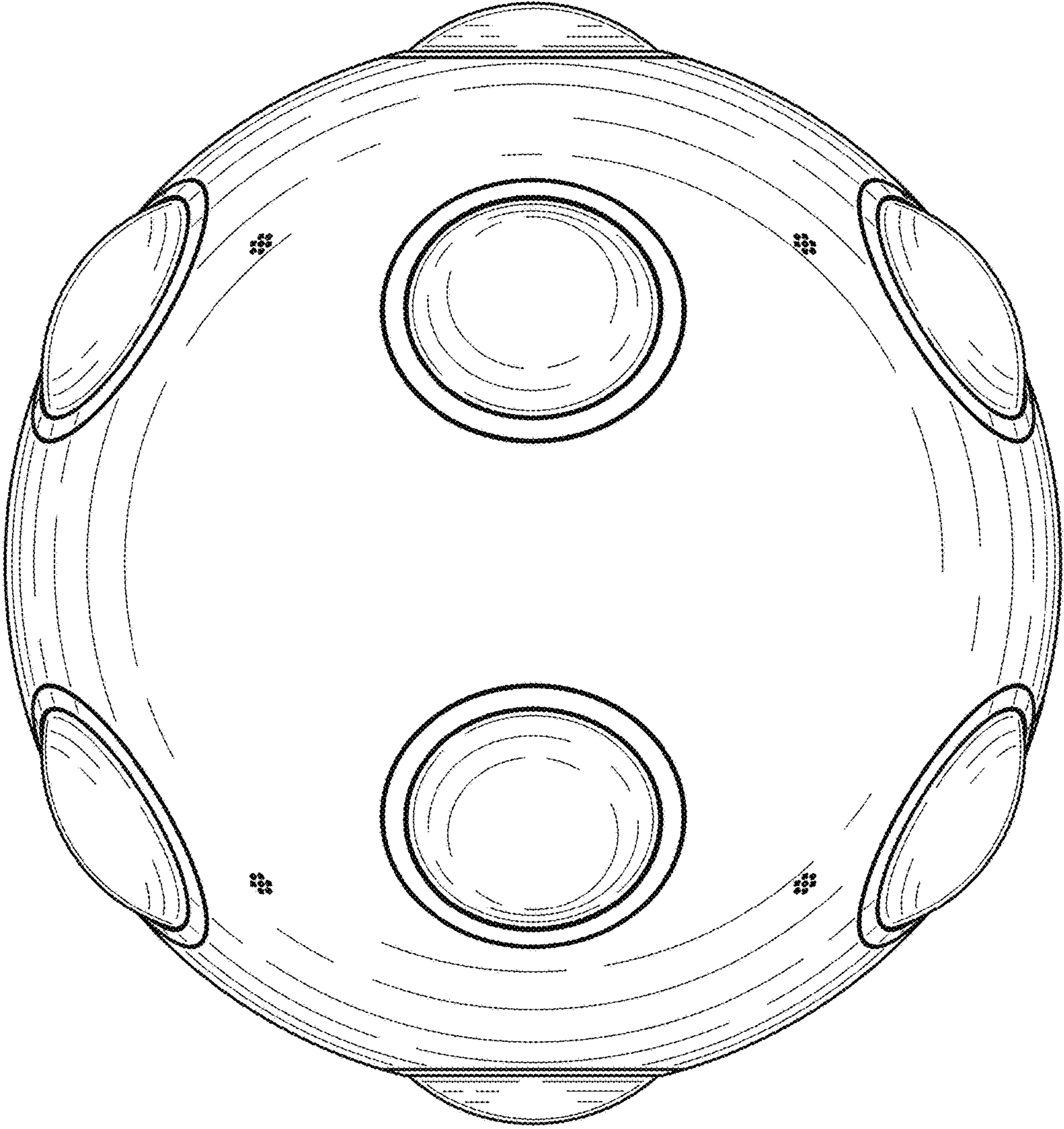

FIG. 6



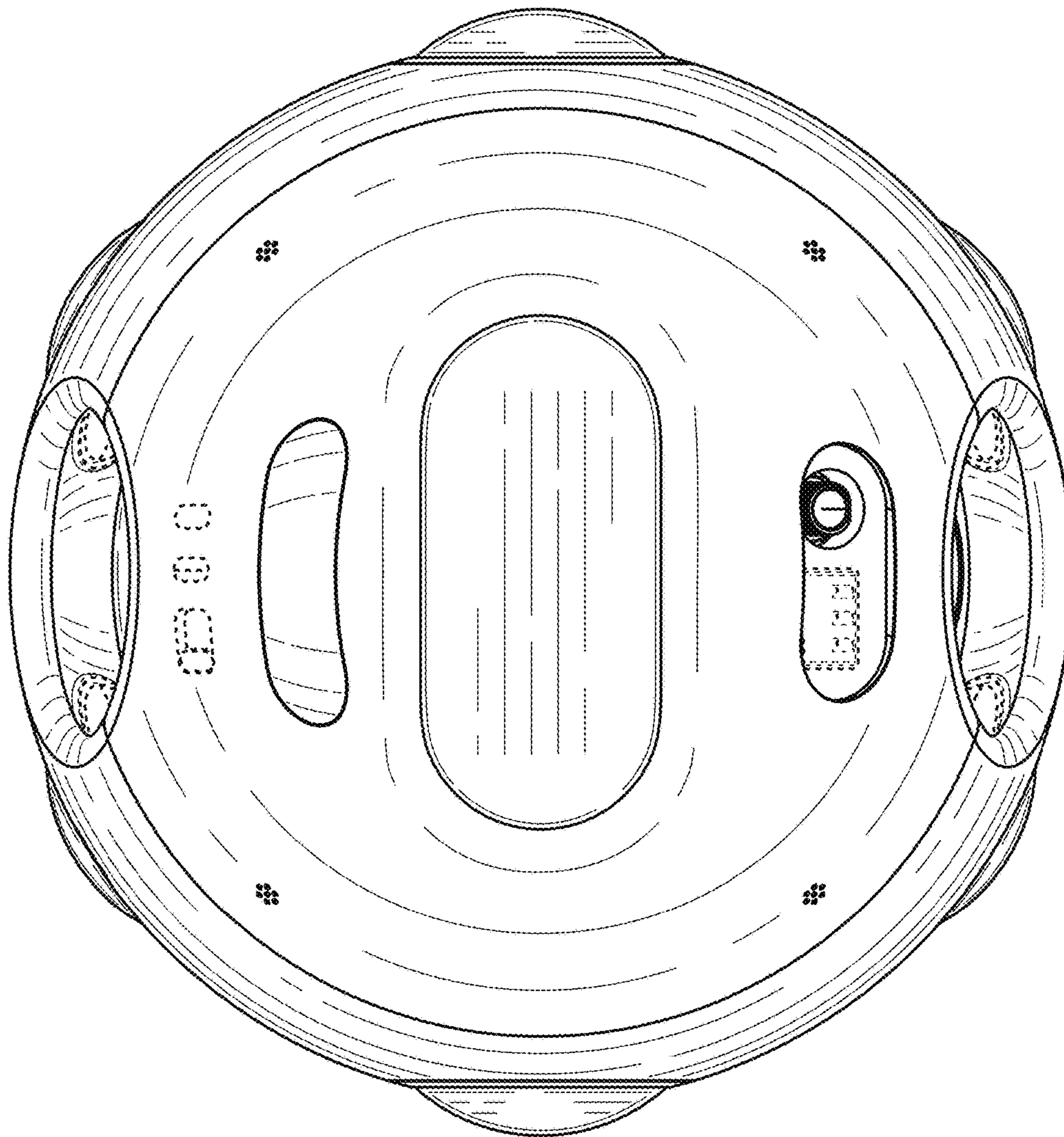

FIG. 7