



US00D792370S

(12) **United States Design Patent**  
**Irányi et al.**

(10) **Patent No.:** **US D792,370 S**  
(45) **Date of Patent:** **\*\* Jul. 18, 2017**

(54) **PAGER**

67/125; H04M 11/022; H04N 7/147;  
H05K 5/00; H04W 12/02

(71) Applicant: **Swissphone Wireless AG**, Samstagern  
(CH)

See application file for complete search history.

(72) Inventors: **Daniel Irányi**, Steinhausen (CH); **Anita Leitmeyr**, Zurich (CH); **Tom Stäubli**, Zurich (CH)

(56) **References Cited**

U.S. PATENT DOCUMENTS

(73) Assignee: **SWISSPHONE WIRELESS AG**,  
Samstagern (CH)

D549,686	S	*	8/2007	Leung	.....	D14/168
D616,464	S	*	5/2010	Park	.....	D14/203.1
D634,727	S	*	3/2011	Wakabayashi	.....	D14/167
D705,748	S	*	5/2014	He	.....	D14/155
D707,198	S	*	6/2014	Bouزيد	.....	D14/167
D707,651	S	*	6/2014	Tsai	.....	D14/191

(\*\*) Term: **14 Years**

\* cited by examiner

(21) Appl. No.: **29/512,124**

*Primary Examiner* — Keli L Hill

(22) Filed: **Dec. 17, 2014**

(74) *Attorney, Agent, or Firm* — Fredrikson & Byron,  
P.A.

(30) **Foreign Application Priority Data**

(57) **CLAIM**

Jun. 19, 2014 (WO) ..... 821504001

We claim the ornamental design for a pager, as shown and described.

(51) **LOC (10) Cl.** ..... **14-03**

**DESCRIPTION**

(52) **U.S. Cl.**

USPC ..... **D14/191**

(58) **Field of Classification Search**

USPC ..... D14/135, 137, 139, 155, 157, 188, 191,  
D14/197, 198, 299, 192, 218;  
455/90.1-90.3, 3.01-3.06, 91, 95, 100,  
455/128, 351; 340/7.1, 7.2, 7.57, 7.6,  
340/7.62, 7.63

CPC .... G05D 23/1905; G08B 3/00; G08B 3/1008;  
G08B 3/1025; G08B 3/1058; H04B 1/02;  
H04B 1/04; H04B 1/40; H04B 1/0458;  
H04B 1/0475; H04H 20/38; H04H 40/27;  
H04H 60/37; H04H 60/64; H04H 60/73;  
H04L 12/1813; H04L 12/1822; H04L

FIG. 1 is a perspective view of a pager incorporating our new design;

FIG. 2 is a front elevational view thereof;

FIG. 3 is a right side view thereof;

FIG. 4 is a rear elevational view thereof;

FIG. 5 is a left side view thereof;

FIG. 6 is a top view thereof; and,

FIG. 7 is a bottom view thereof.

The broken lines shown are included for the purpose of illustrating portions of the pager that form no part of the claim.

**1 Claim, 6 Drawing Sheets**

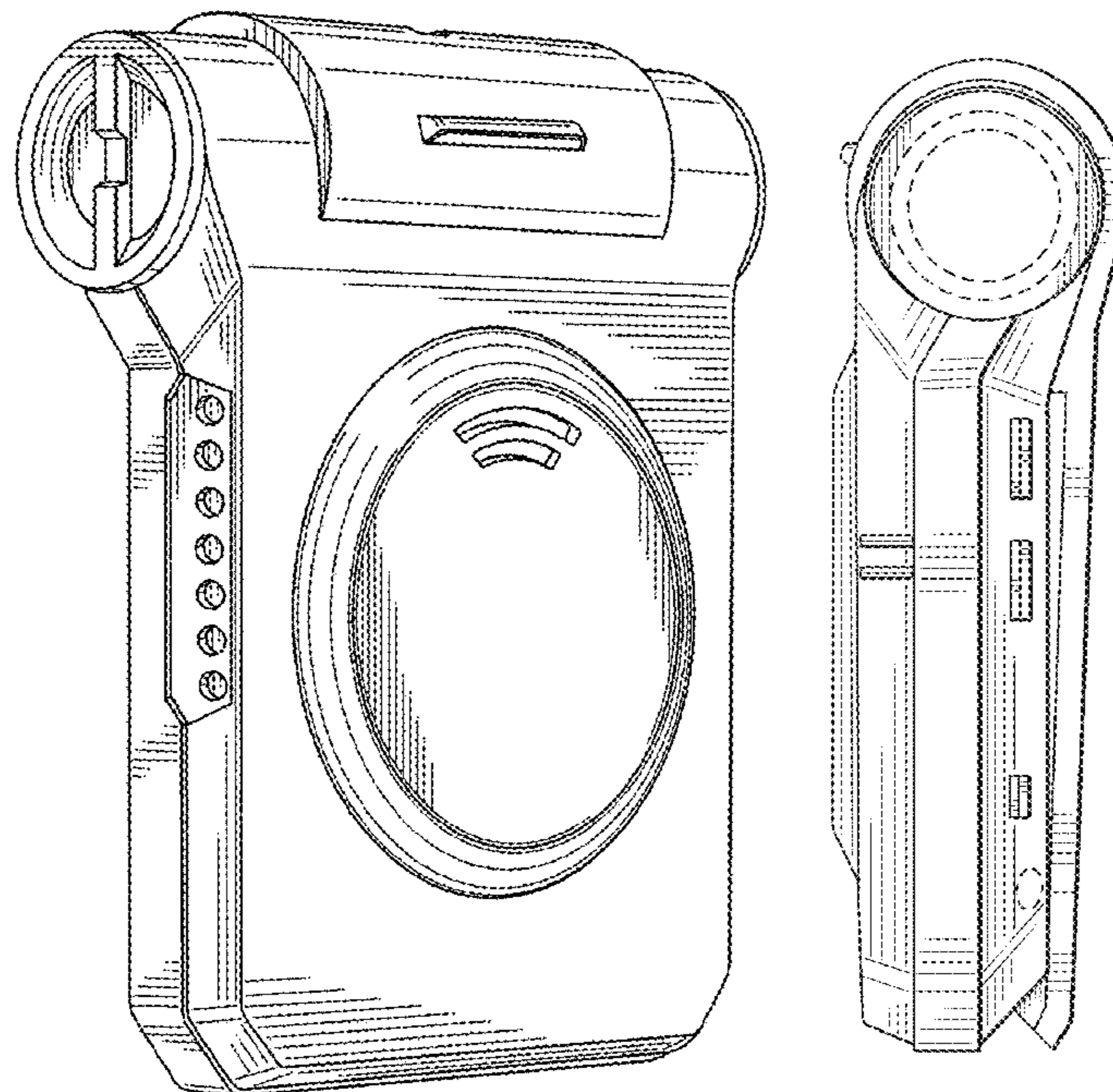

**Fig. 1**

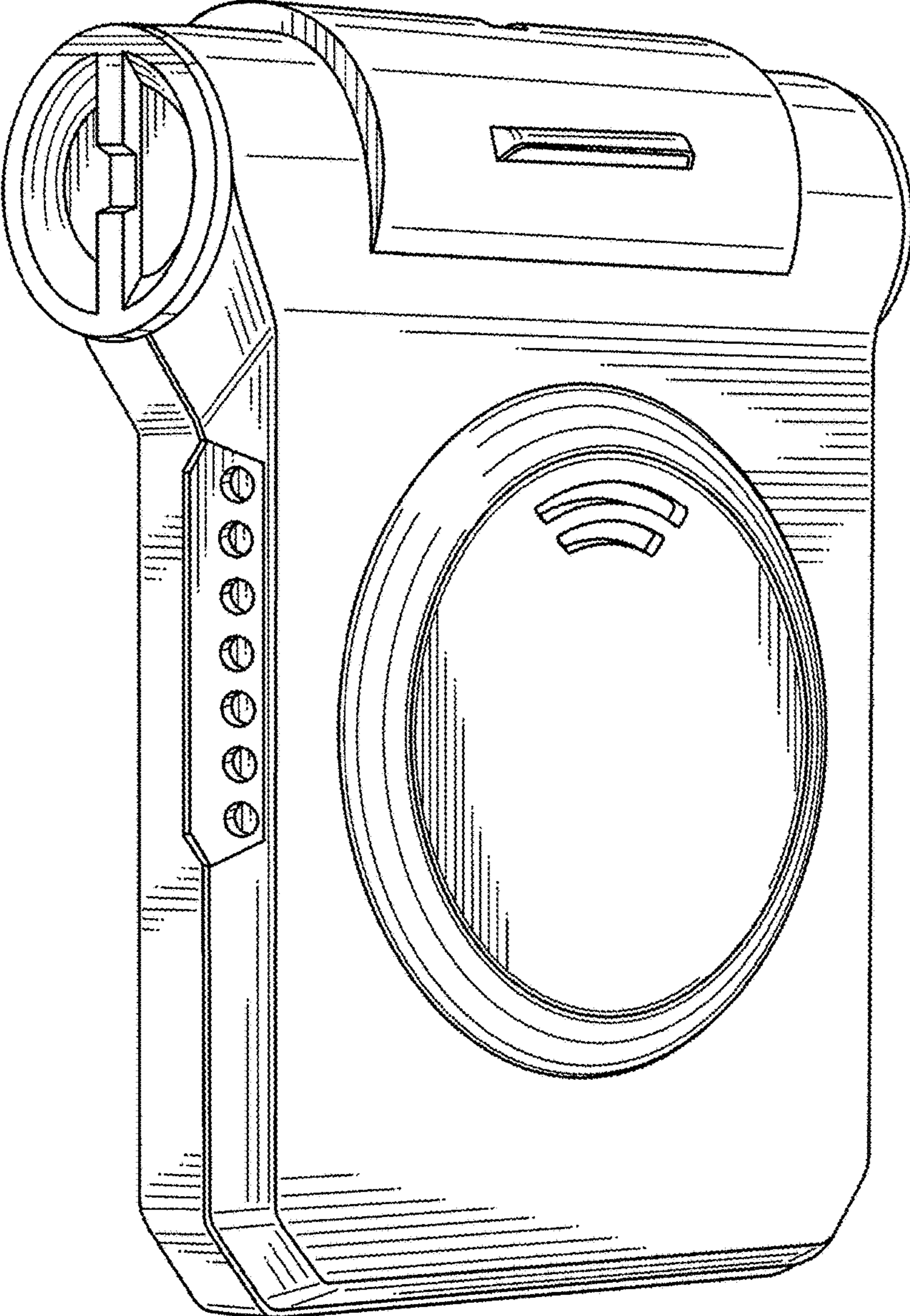

**Fig. 2**

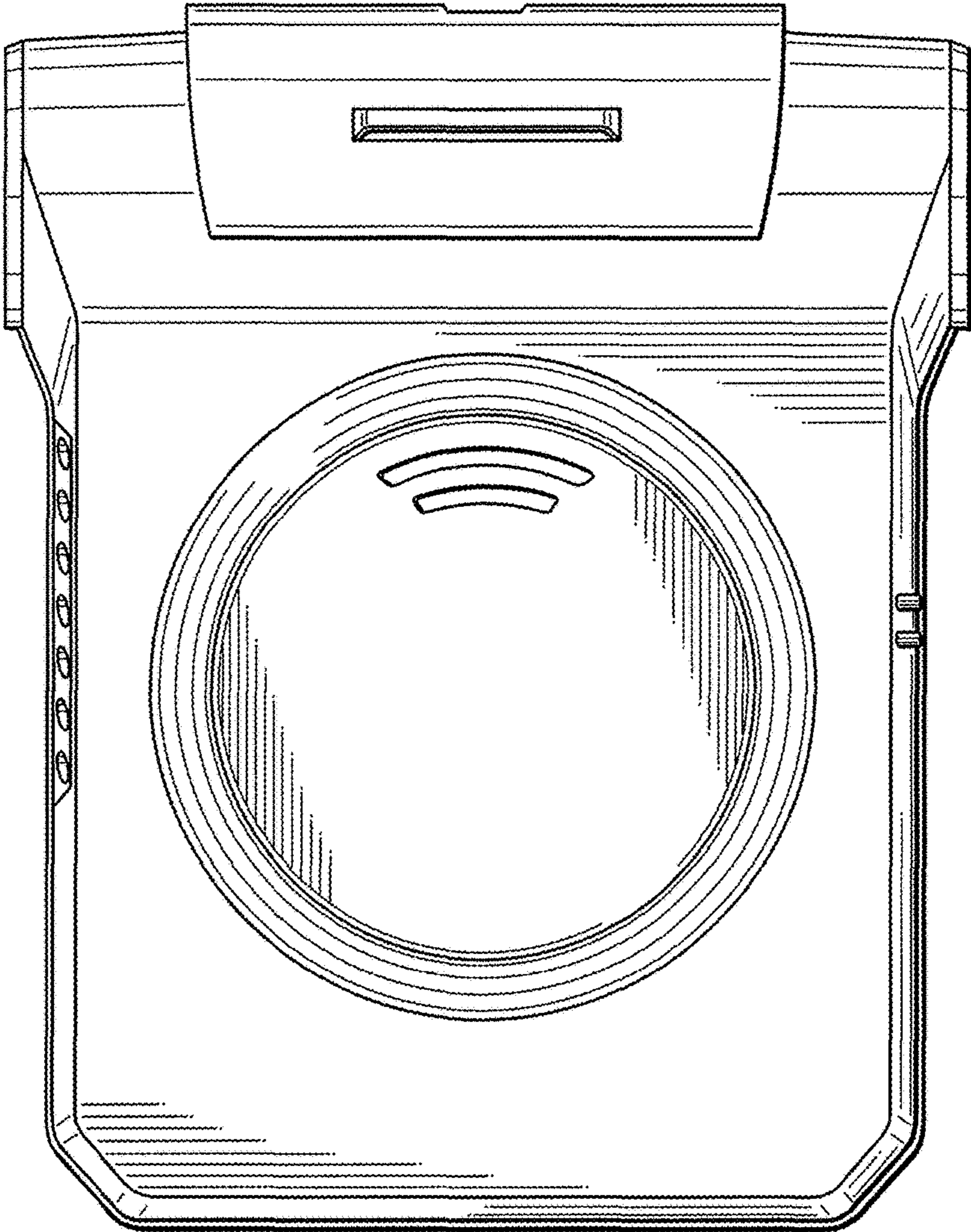

**Fig. 3**

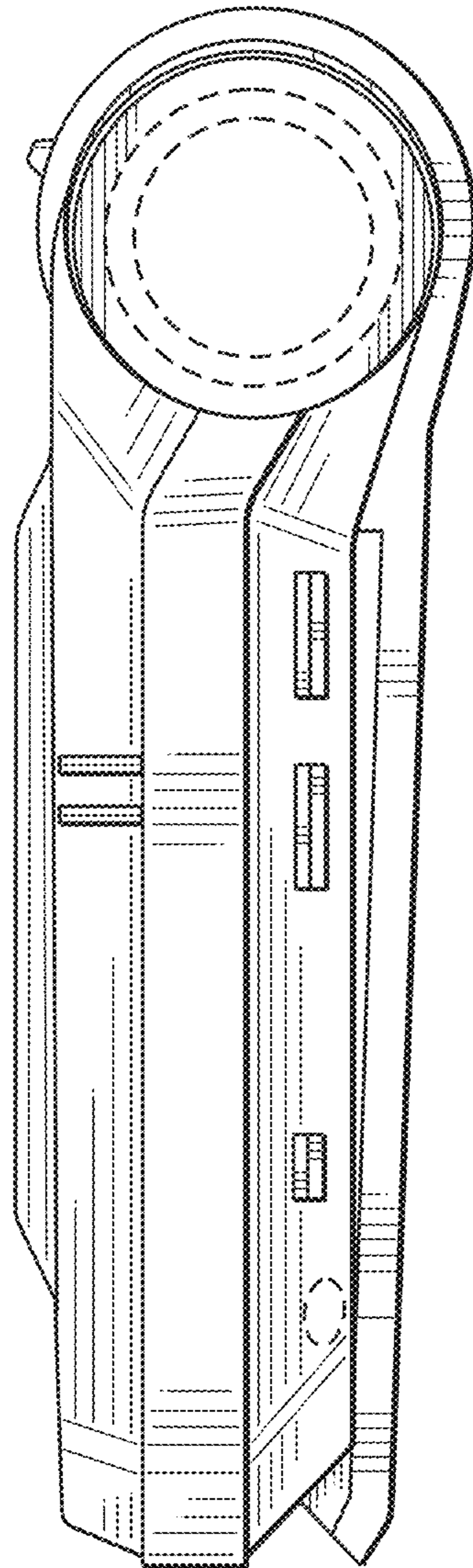

**Fig. 4**

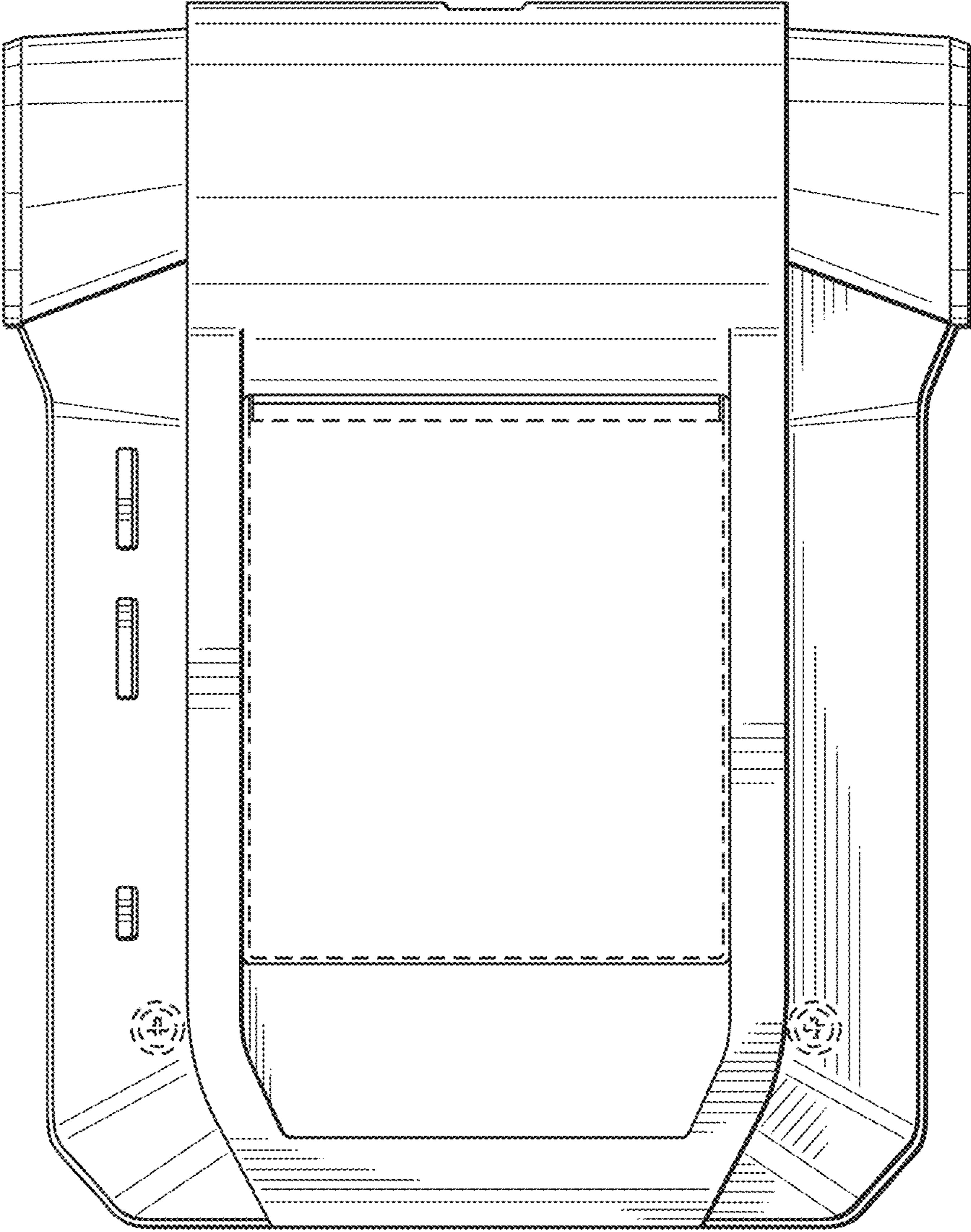

**Fig. 5**

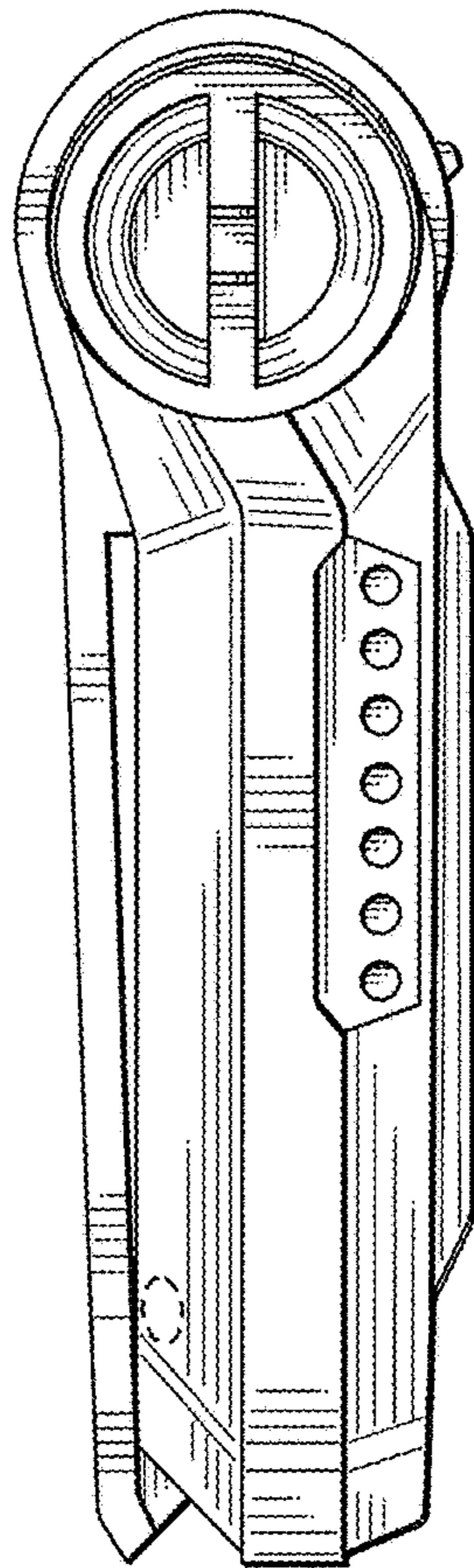

**Fig. 6**

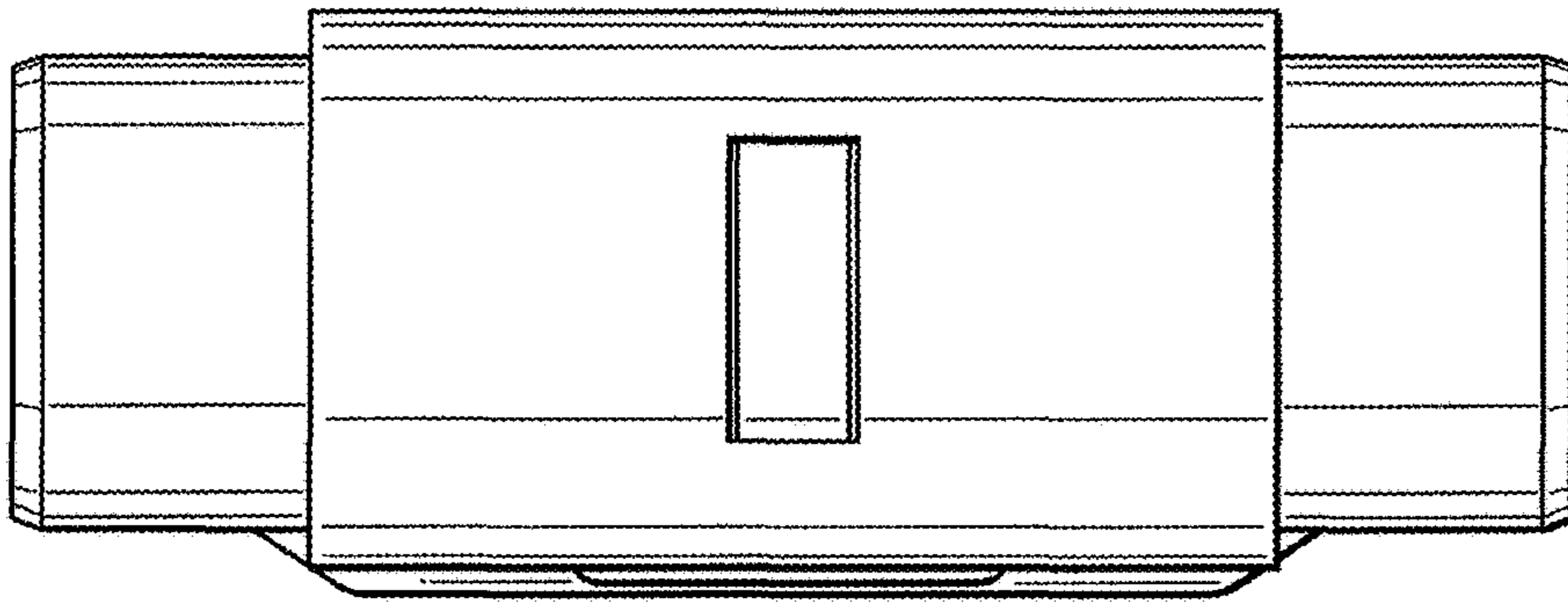

**Fig. 7**

