



US00D792144S

(12) **United States Design Patent** (10) **Patent No.:** **US D792,144 S**
Caron (45) **Date of Patent:** **** Jul. 18, 2017**

(54) **OBJECT BLOCKING DEVICE FOR UNDERNEATH FURNITURE**

(71) Applicant: **Mark Caron**, Chicago, IL (US)

(72) Inventor: **Mark Caron**, Chicago, IL (US)

(**) Term: **15 Years**

(21) Appl. No.: **29/540,480**

(22) Filed: **Sep. 24, 2015**

(51) **LOC (10) Cl.** **06-01**

(52) **U.S. Cl.**
USPC **D6/719**

(58) **Field of Classification Search**
USPC D6/334, 335, 336, 338, 349, 355, 381,
D6/716, 716.1, 719; 297/118, 119, 135,
(Continued)

(56) **References Cited**

U.S. PATENT DOCUMENTS

618,264 A 1/1899 Burtless
2,087,574 A * 7/1937 Kaufer A47C 13/005
297/113

(Continued)

Primary Examiner — Sandra Snapp

(74) *Attorney, Agent, or Firm* — K&L Gates LLP

(57) **CLAIM**

I claim the ornamental design for the object blocking device for underneath furniture, as shown and described.

DESCRIPTION

FIG. 1 is a top, front, right side perspective view of one embodiment of an object blocking device for underneath furniture of the present disclosure;
FIG. 2 is a front view thereof;

FIG. 3 is an enlarged, sectioned front view of the left side of FIG. 2;

FIG. 4 is an enlarged, sectioned front view of the right side of FIG. 2;

FIG. 5 is an enlarged, sectioned rear view of the left side of FIG. 2;

FIG. 6 is an enlarged, sectioned rear view of the right side of FIG. 2;

FIG. 7 is an enlarged, sectioned bottom view of the left side of FIG. 2;

FIG. 8 is an enlarged, sectioned bottom view of the right side of FIG. 2;

FIG. 9 is an enlarged side view of the left or right side of FIG. 2;

FIG. 10 is a top, front, right side perspective view of another embodiment of an object blocking device for underneath furniture of the present disclosure;

FIG. 11 is a front view thereof;

FIG. 12 is an enlarged, sectioned front view of the left side of FIG. 11;

FIG. 13 is an enlarged, sectioned front view of the right side of FIG. 11;

FIG. 14 is an enlarged, sectioned rear view of the left side of FIG. 11;

FIG. 15 is an enlarged, sectioned rear view of the right side of FIG. 11;

FIG. 16 is an enlarged, sectioned bottom view of the left side of FIG. 11;

FIG. 17 is an enlarged, sectioned bottom view of the right side of FIGS. 11; and,

FIG. 18 is an enlarged side view of the left or right side of FIG. 11.

The dashed lines in FIGS. 1 and 10 depicting a piece of furniture are for environmental purposes only and form no part of the claimed design. The object blocking device is shown in FIGS. 10 and 11 with a symbolic break in its length. The appearance of any portion of the article between the break lines in FIGS. 10 and 11 forms no part of the claimed design.

1 Claim, 18 Drawing Sheets

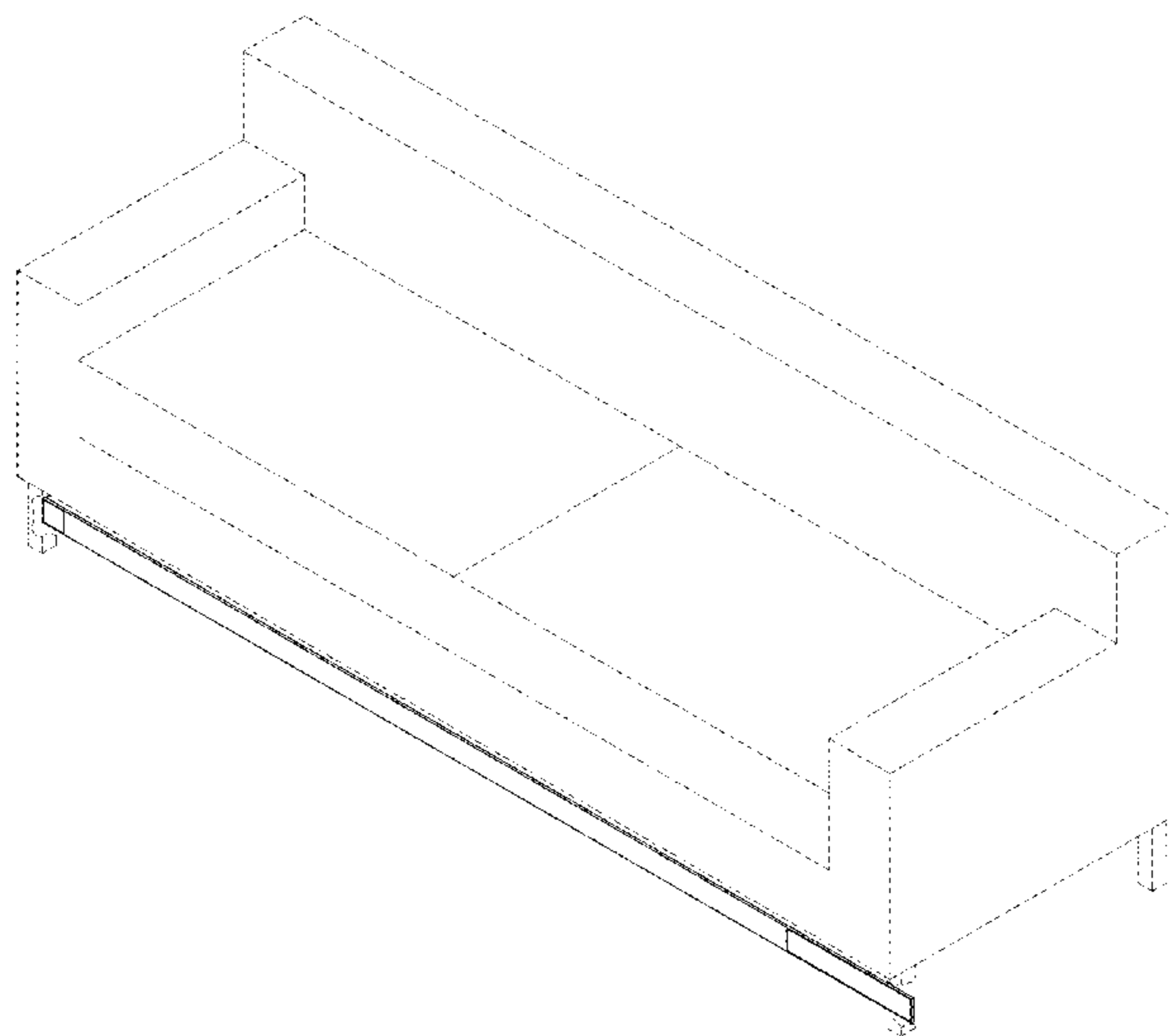

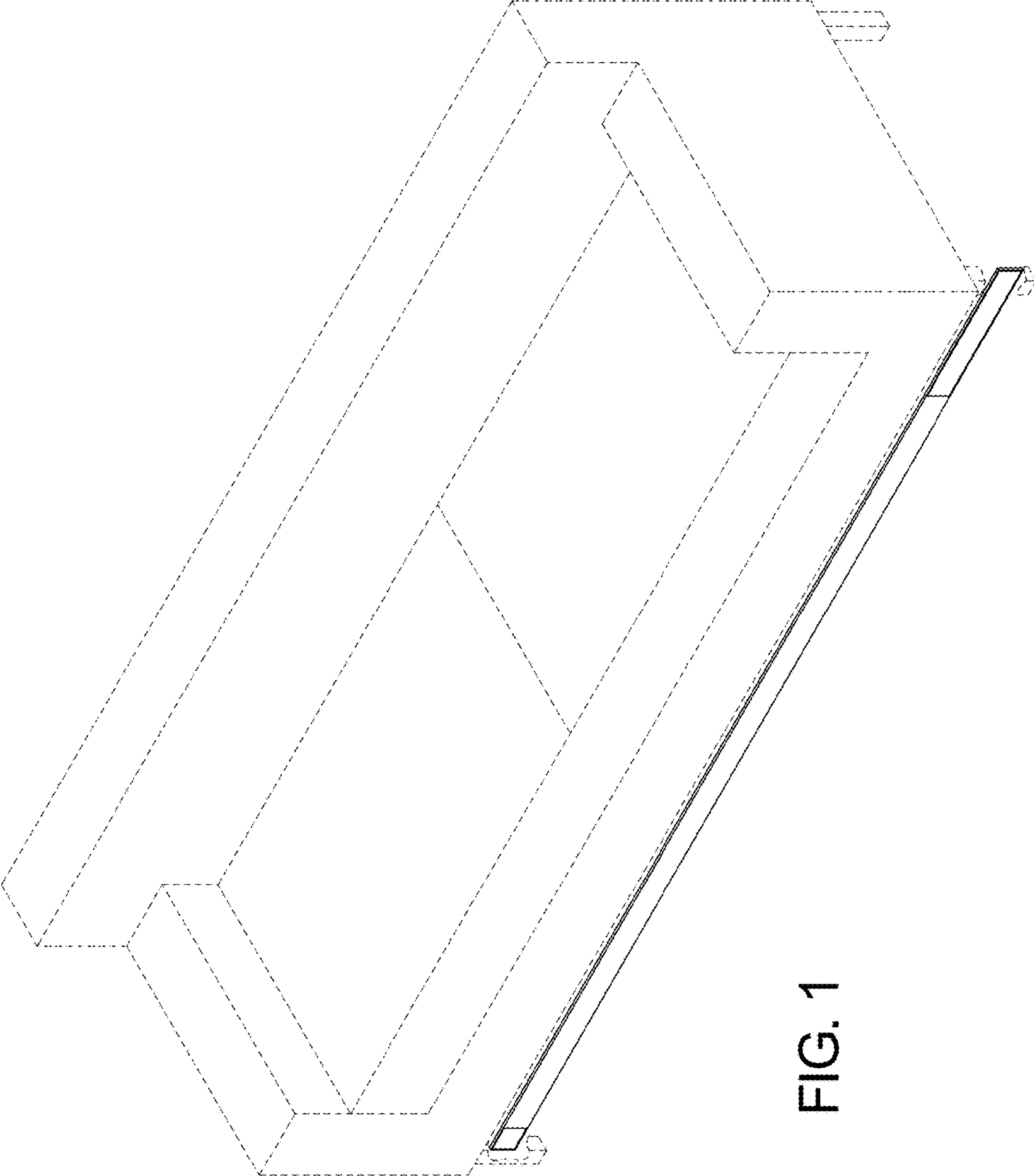

FIG. 1

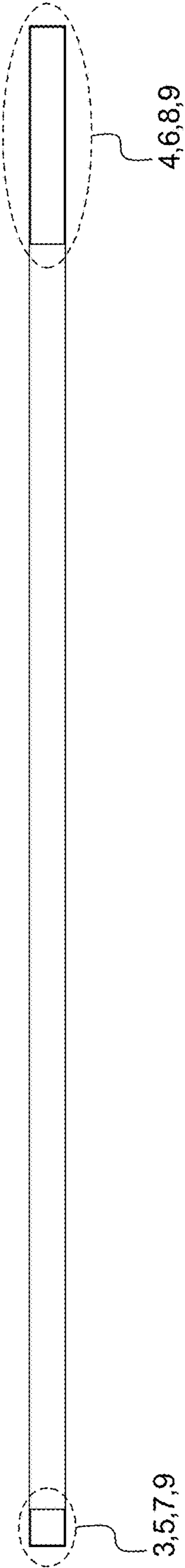

FIG. 2

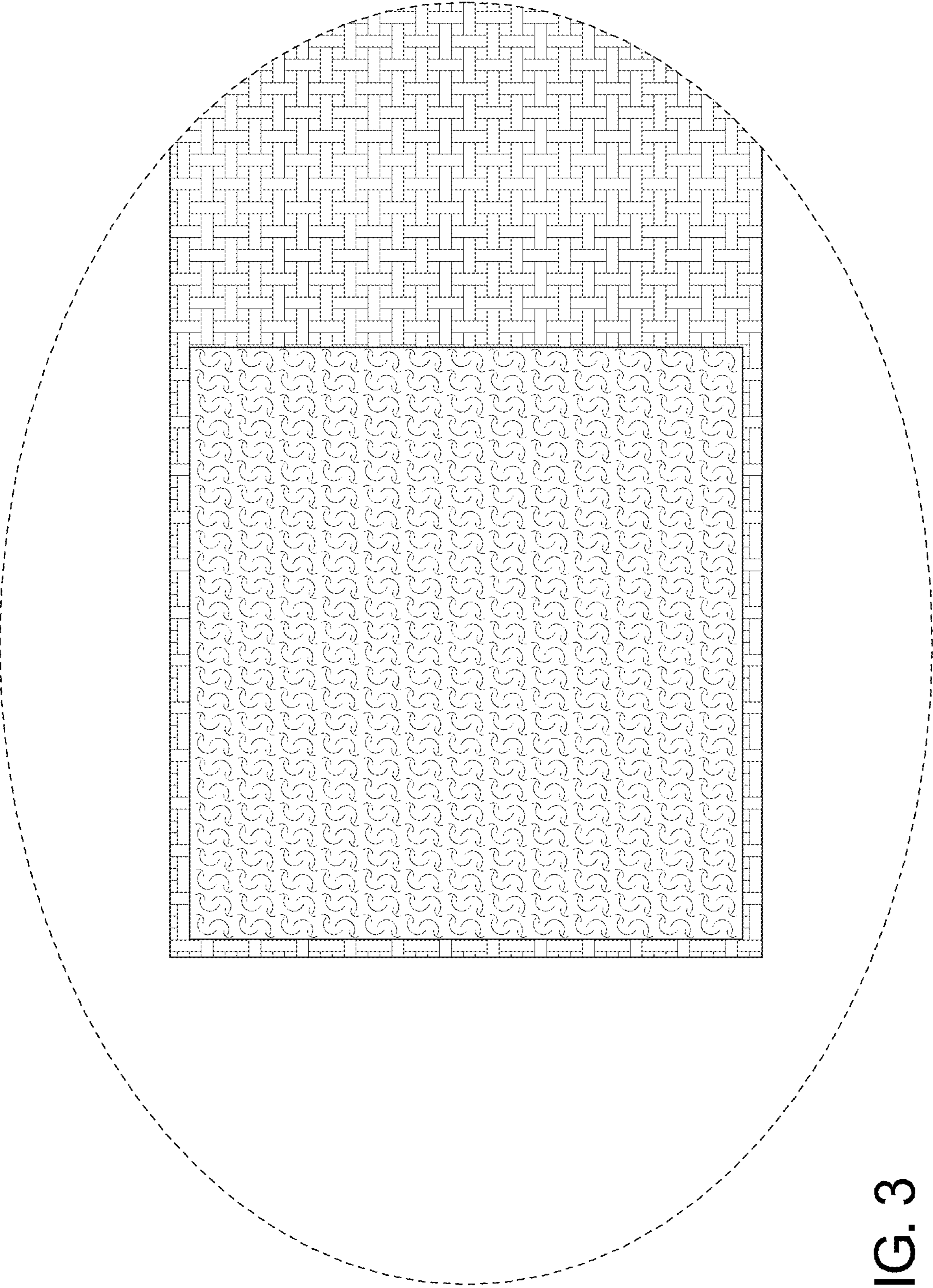

FIG. 3

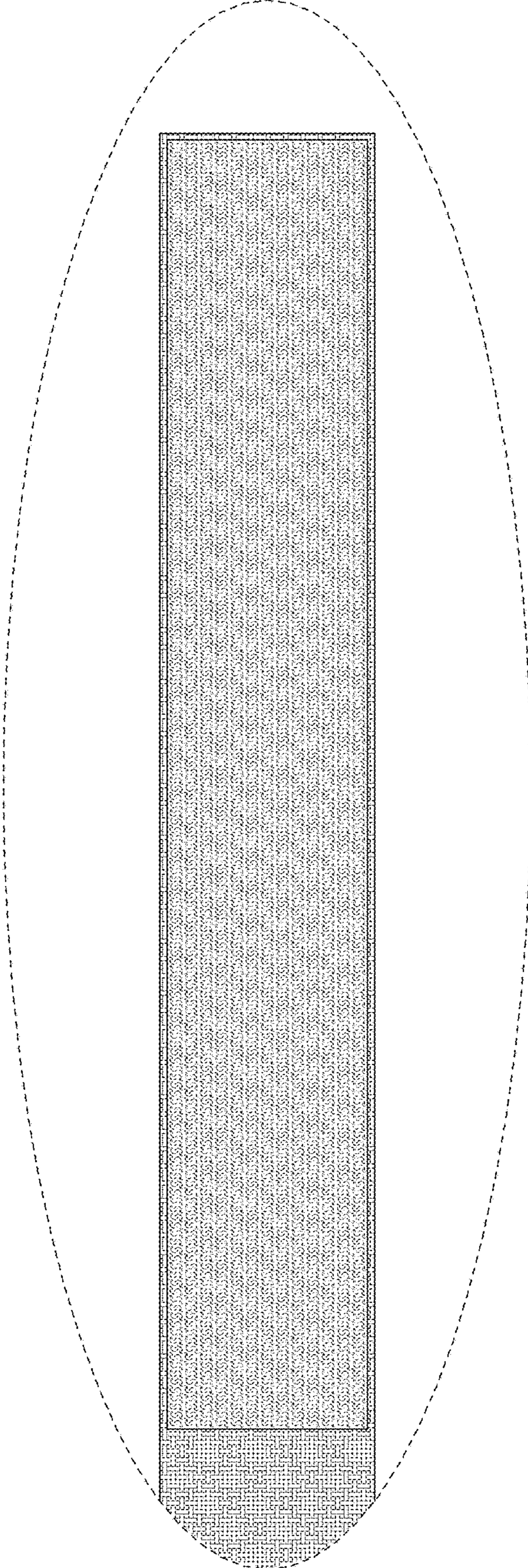

FIG. 4

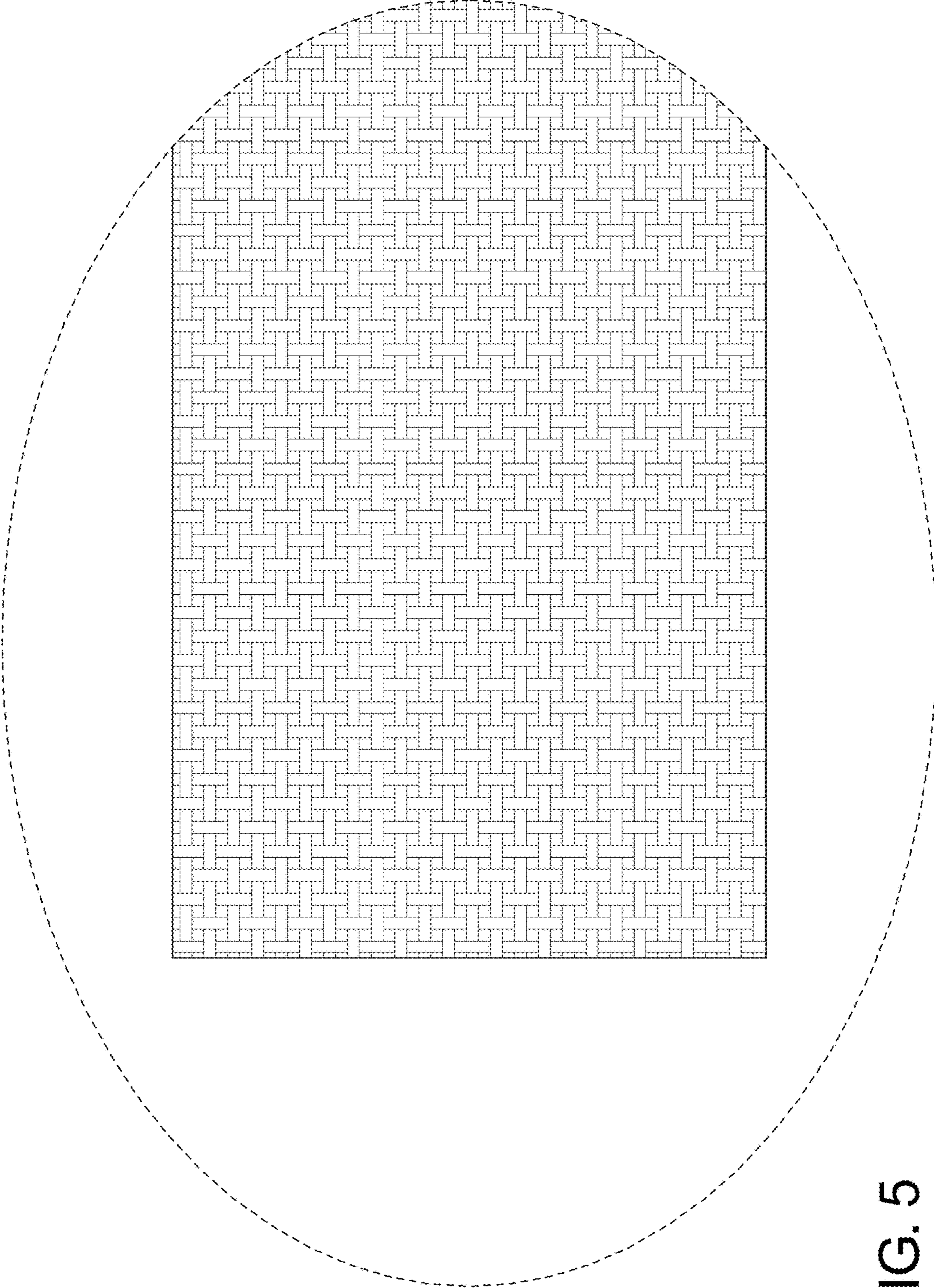

FIG. 5

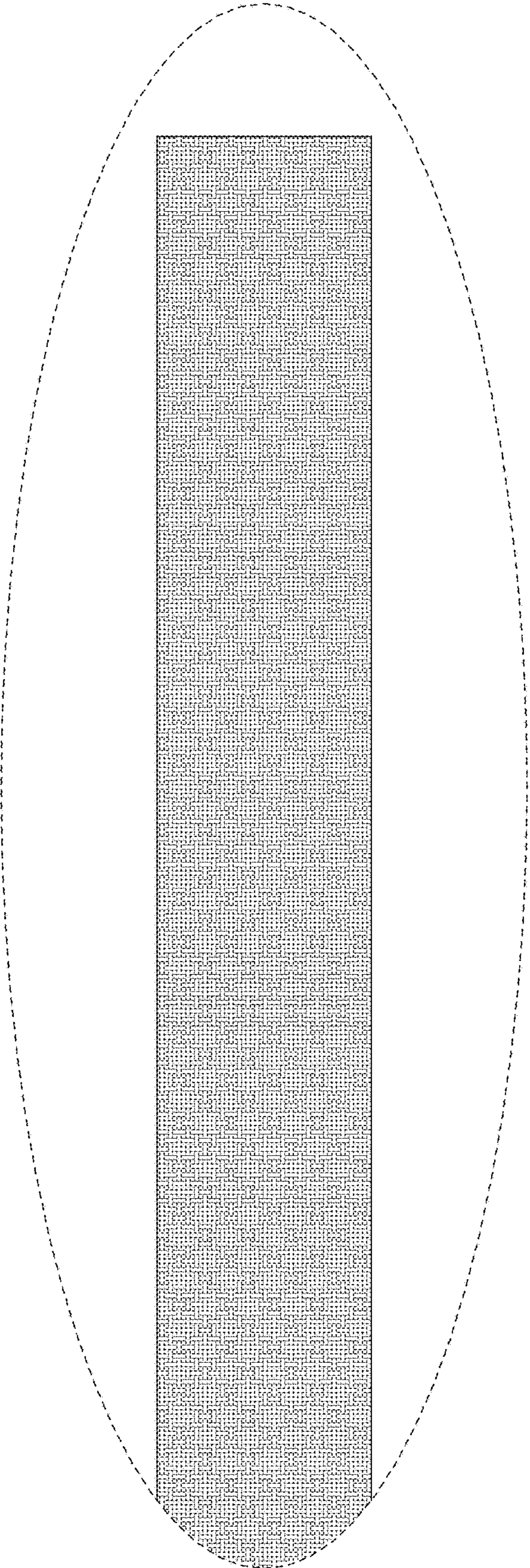

FIG. 6

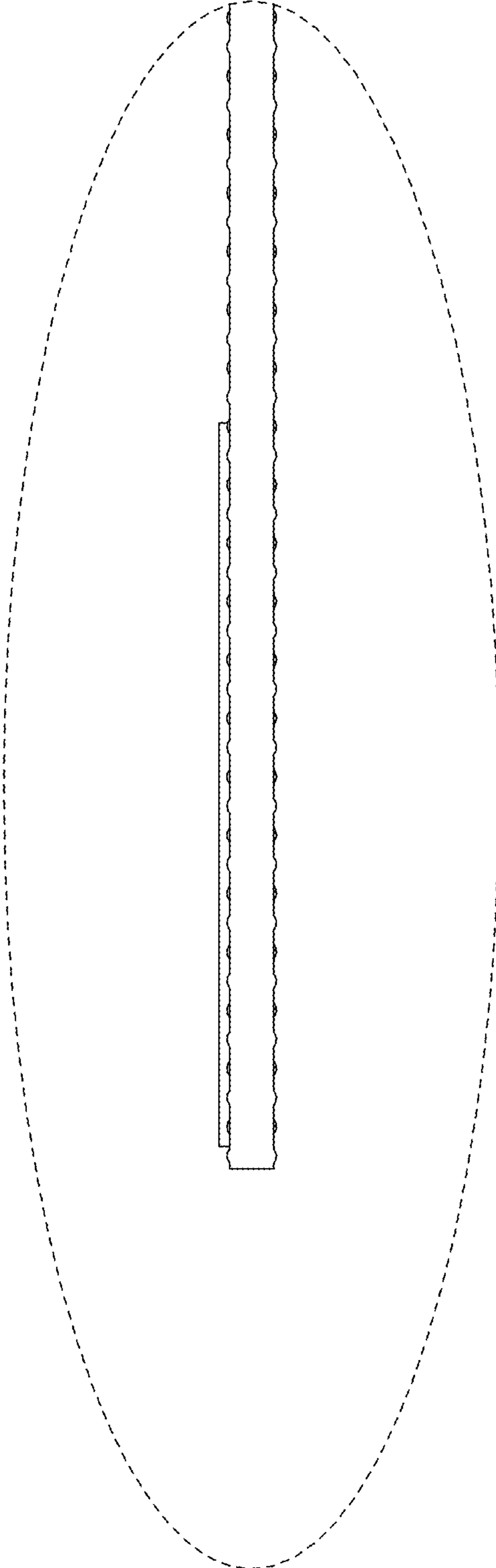

FIG. 7

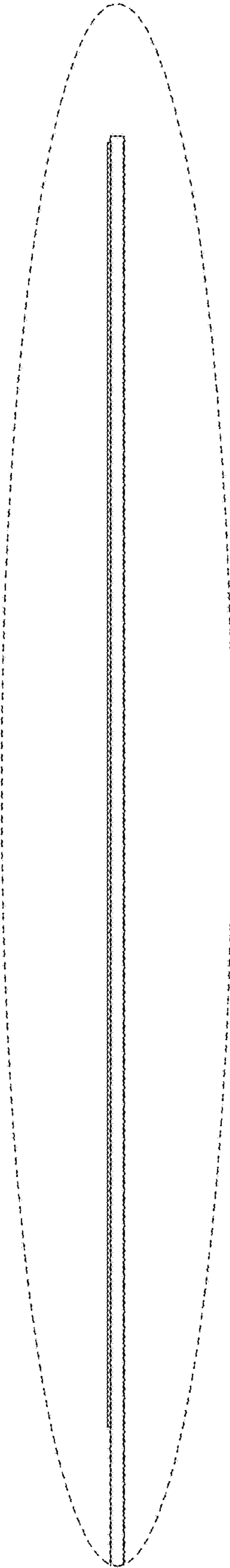

FIG. 8

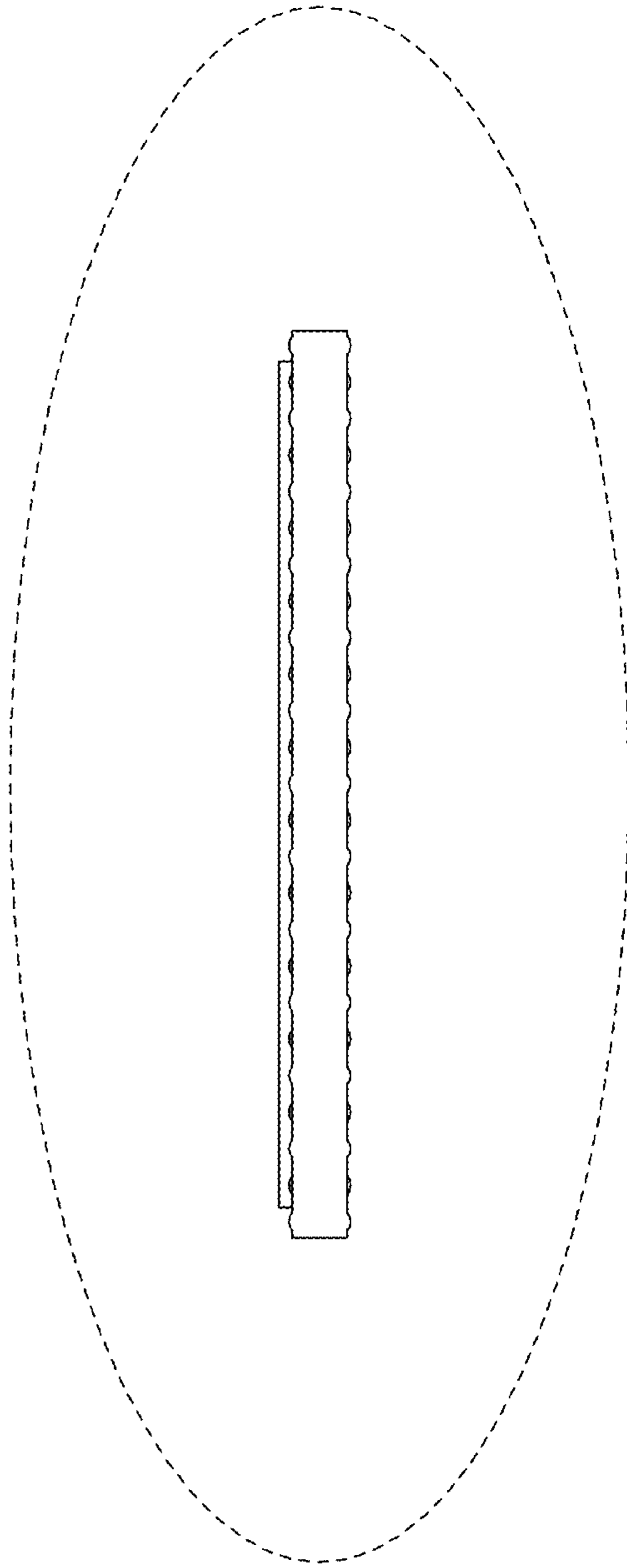

FIG. 9

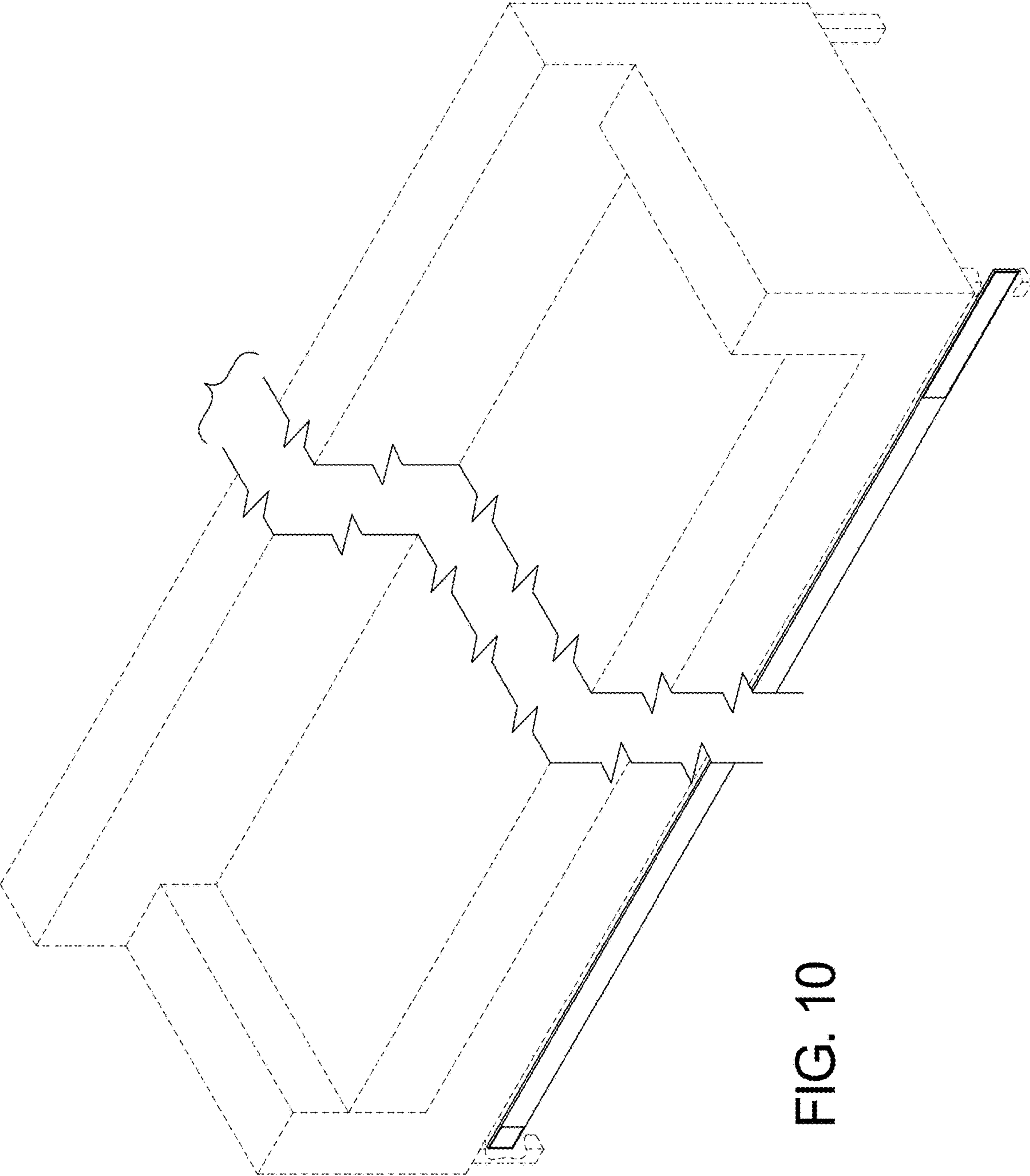

FIG. 10

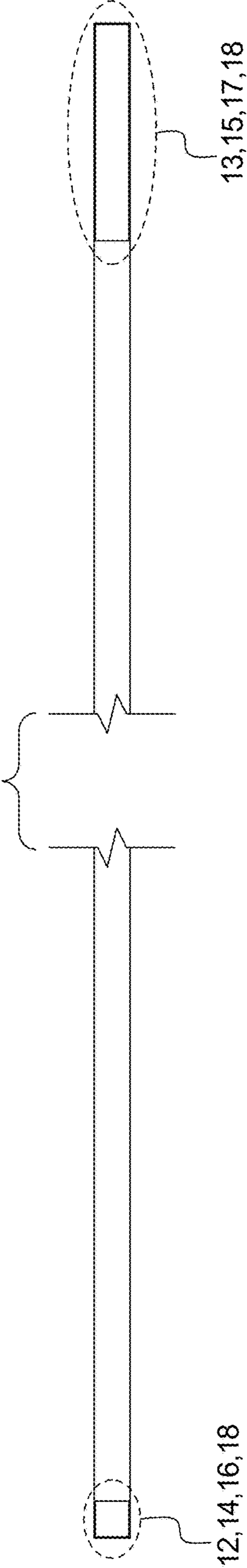

FIG. 11

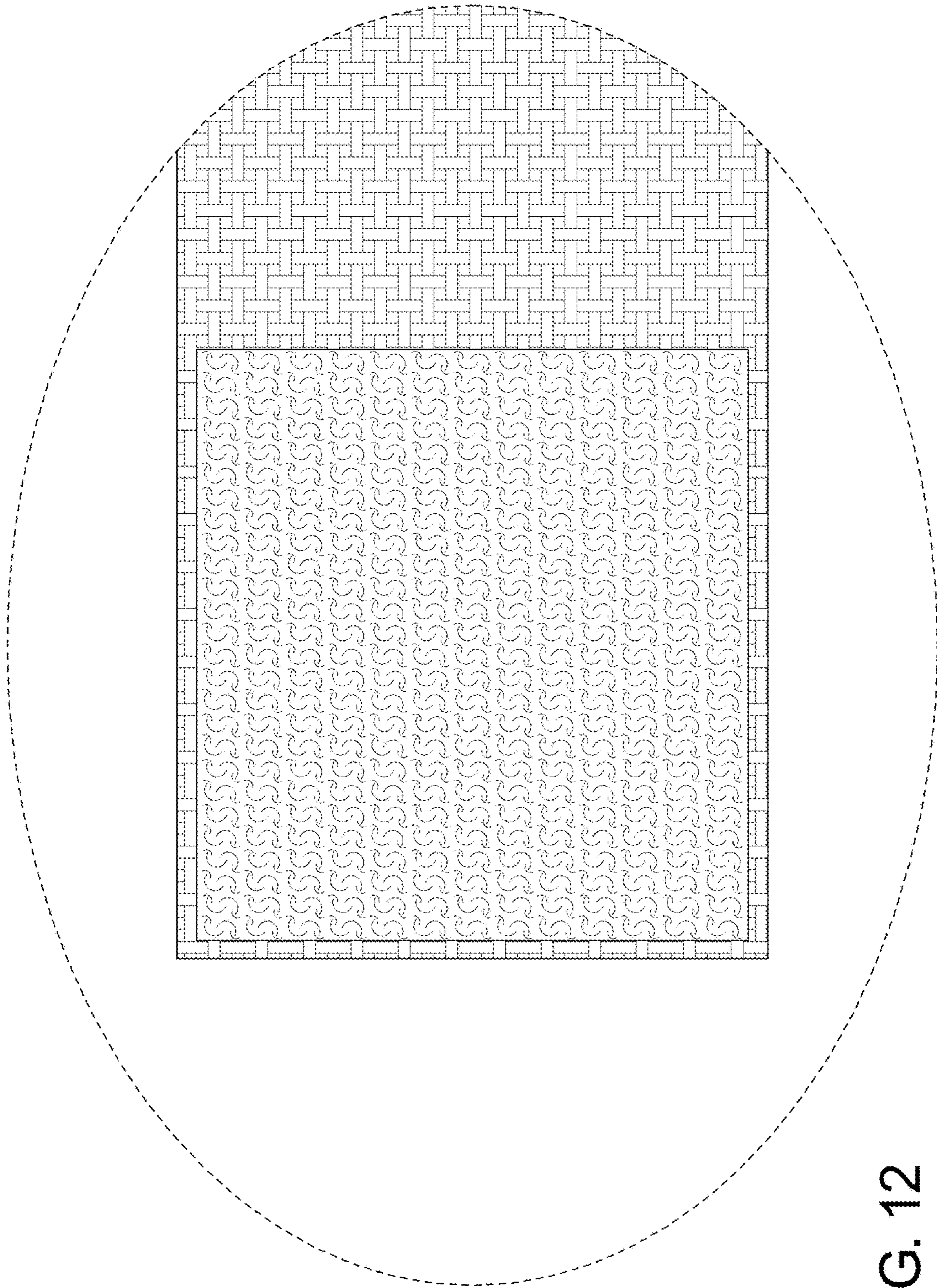

FIG. 12

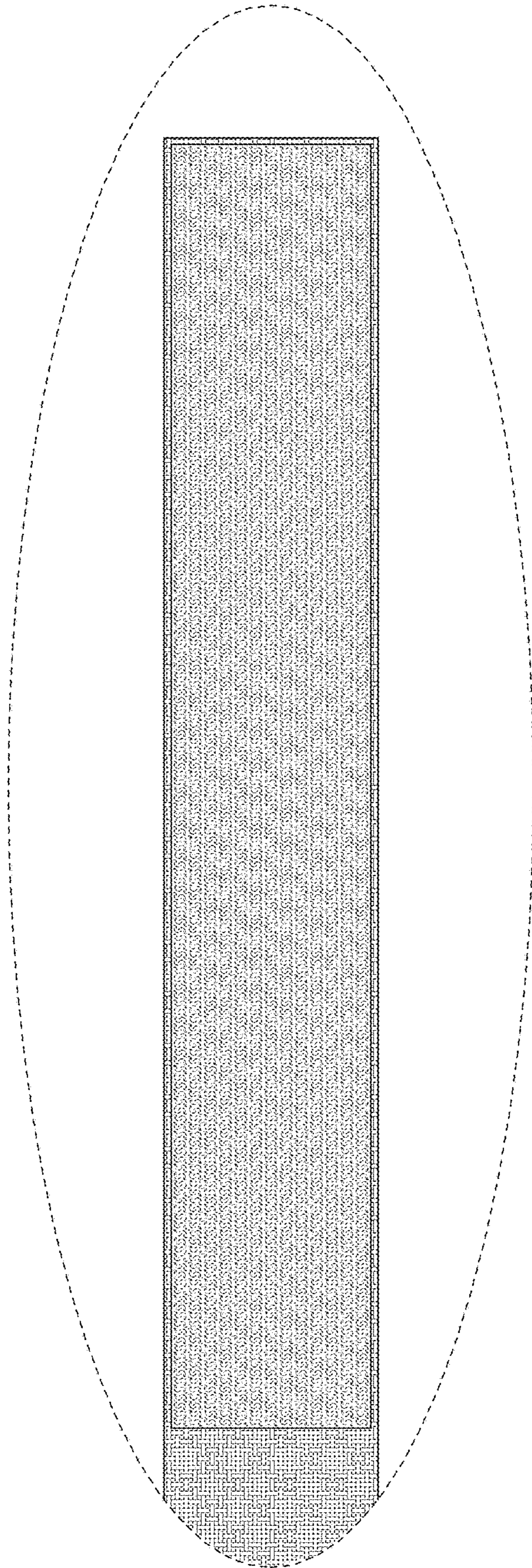

FIG. 13

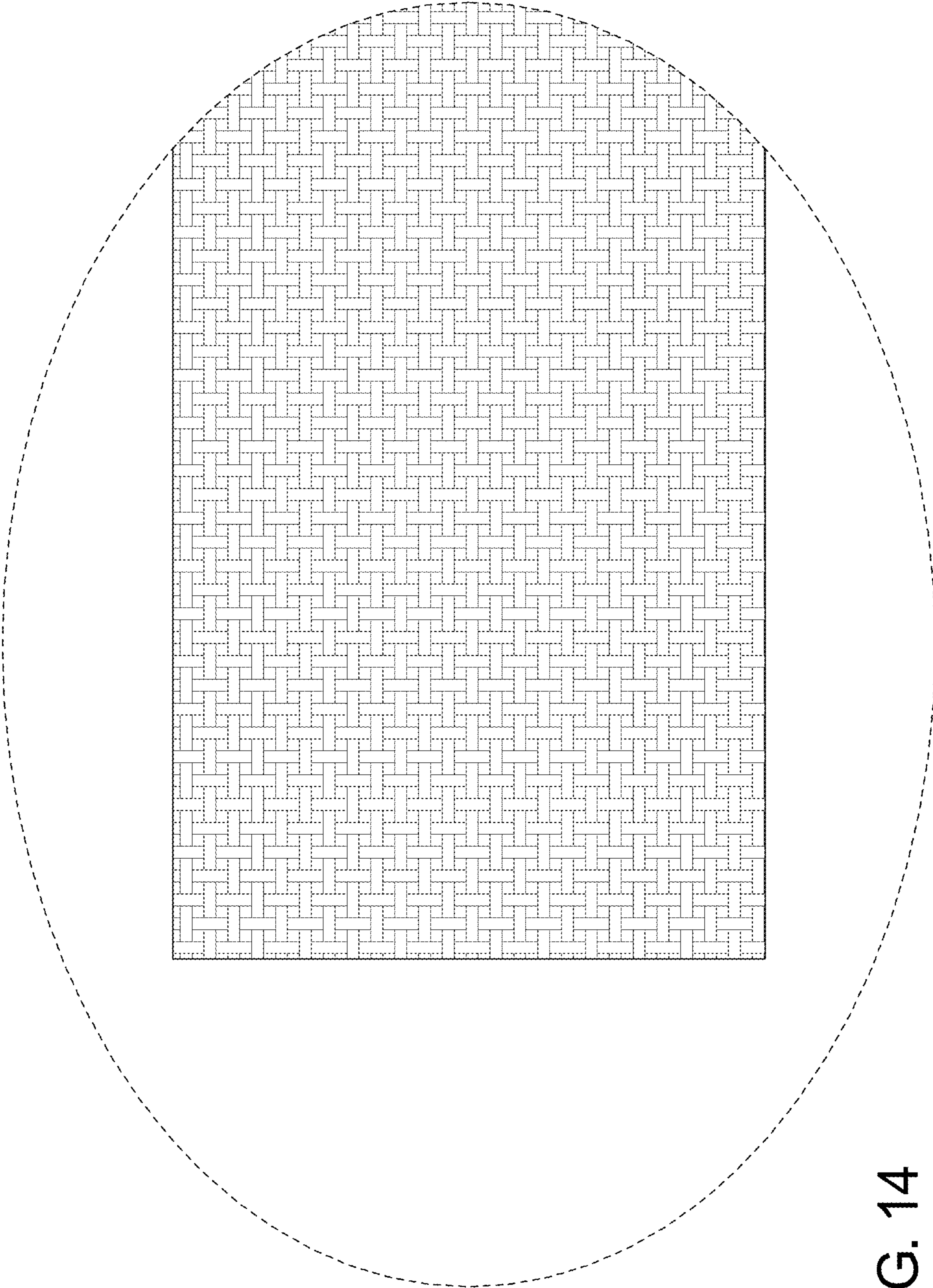

FIG. 14

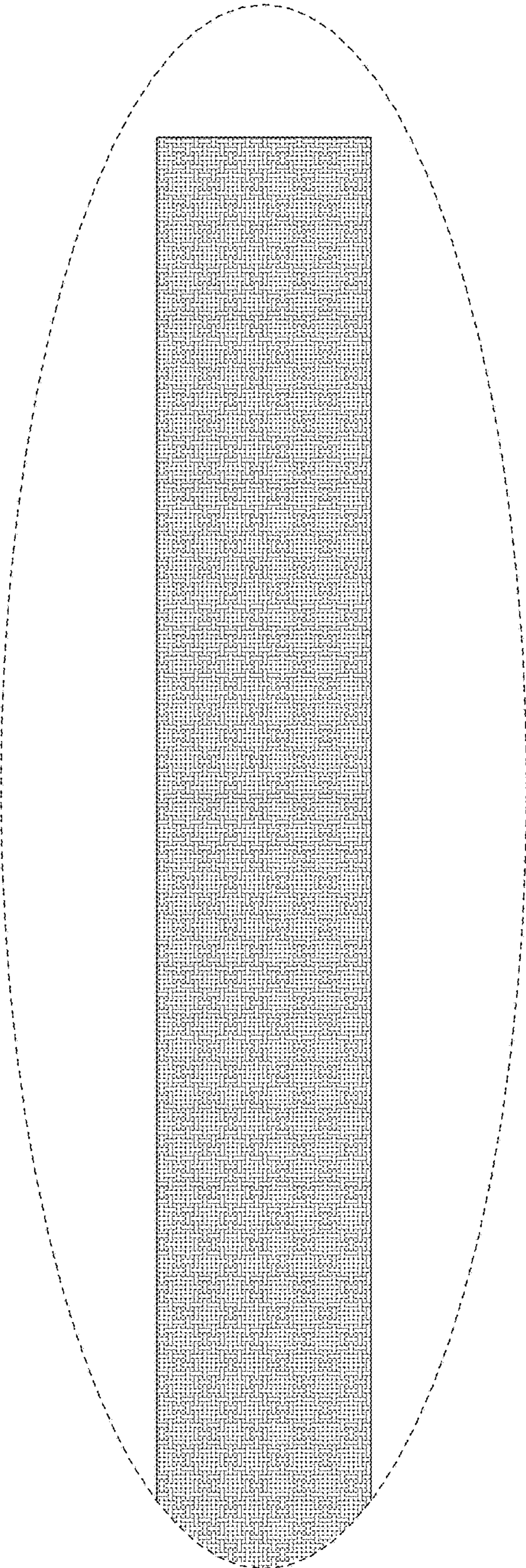

FIG. 15

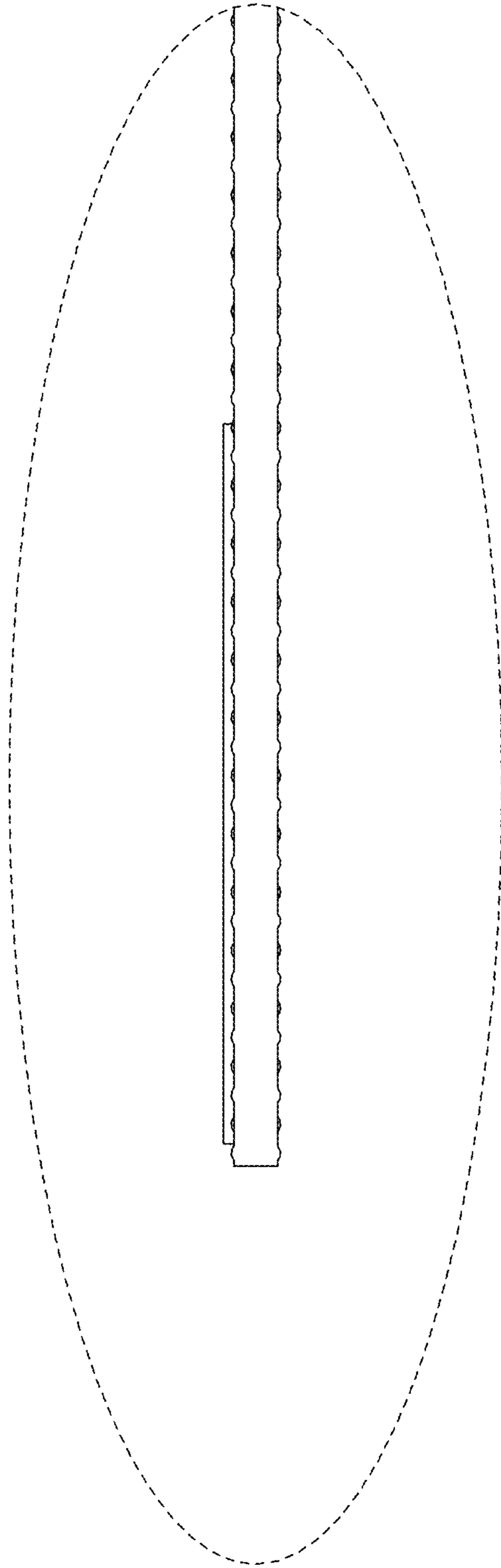

FIG. 16

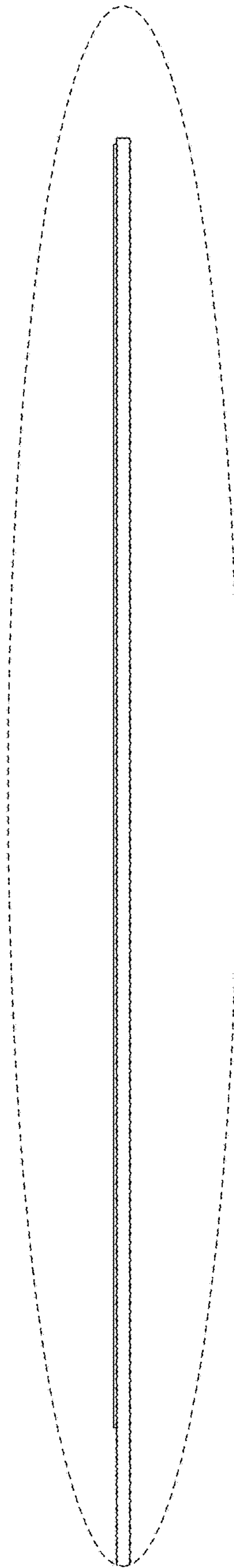

FIG. 17

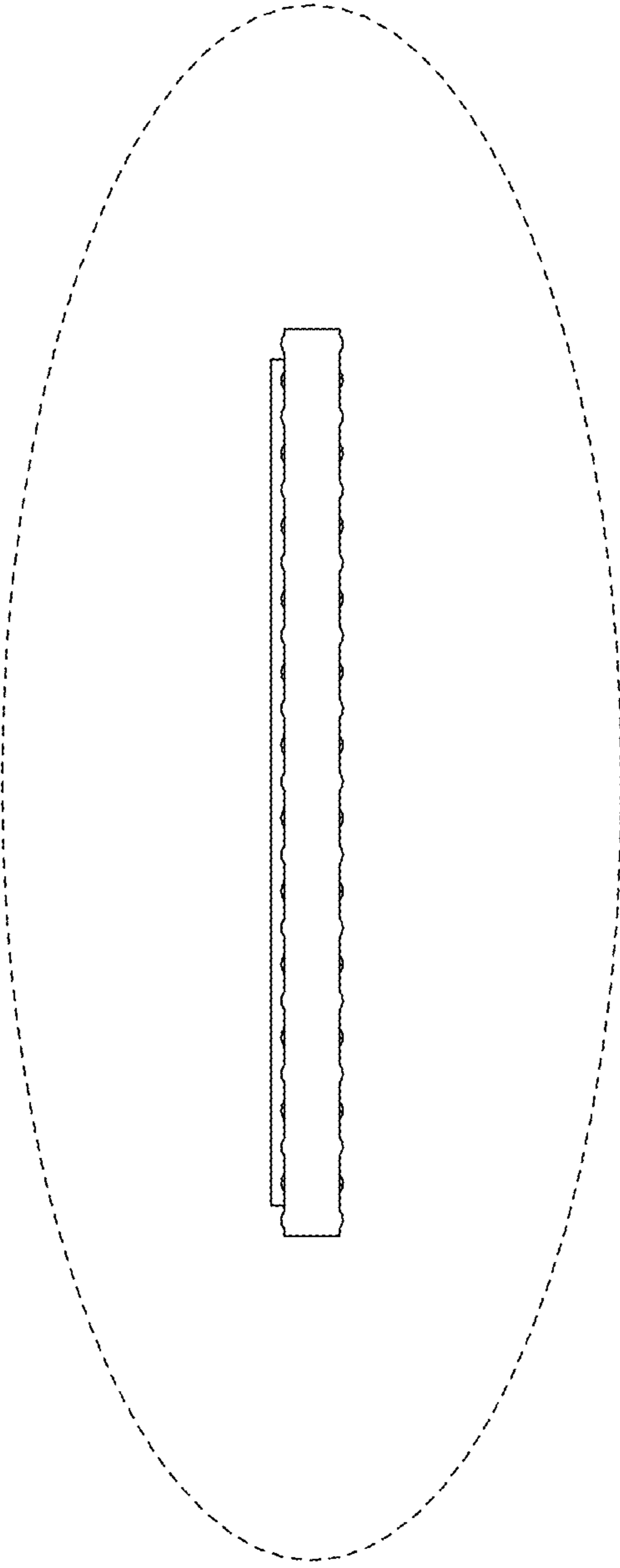

FIG. 18