



US00D792143S

(12) **United States Design Patent**  
**Caron**

(10) **Patent No.:** **US D792,143 S**  
(45) **Date of Patent:** **\*\* Jul. 18, 2017**

(54) **OBJECT BLOCKING DEVICE FOR FURNITURE UNDERSIDES**

(71) Applicant: **Mark Caron**, Chicago, IL (US)

(72) Inventor: **Mark Caron**, Chicago, IL (US)

(\*\*) Term: **14 Years**

(21) Appl. No.: **29/516,617**

(22) Filed: **Feb. 4, 2015**

(51) **LOC (10) Cl.** ..... **06-01**

(52) **U.S. Cl.**  
USPC ..... **D6/719**

(58) **Field of Classification Search**  
USPC ..... D6/334, 335, 336, 338, 349, 355, 381,  
D6/716, 716.1, 719; 297/118, 119, 135,  
(Continued)

(56) **References Cited**

U.S. PATENT DOCUMENTS

618,264 A 1/1899 Burtless  
2,087,574 A \* 7/1937 Kaufer ..... A47C 13/005  
297/113

(Continued)

*Primary Examiner* — Sandra Snapp

(74) *Attorney, Agent, or Firm* — K&L Gates LLP

(57) **CLAIM**

The ornamental design for the object blocking device for furniture undersides, as shown and described.

**DESCRIPTION**

FIG. 1 is a top, front, right side perspective view of one embodiment of an object blocking device for furniture undersides of the present disclosure;  
FIG. 2 is a front view thereof;

FIG. 3 is an enlarged, sectioned front view of the left side of FIG. 2;

FIG. 4 is an enlarged, sectioned front view of the right side of FIG. 2;

FIG. 5 is an enlarged, sectioned rear view of the left side of FIG. 2;

FIG. 6 is an enlarged, sectioned rear view of the right side of FIG. 2;

FIG. 7 is an enlarged, sectioned bottom view of the left side of FIG. 2;

FIG. 8 is an enlarged, sectioned bottom view of the right side of FIG. 2;

FIG. 9 is an enlarged side view of the left or right side of FIG. 2;

FIG. 10 is a top, front, right side perspective view of another embodiment of an object blocking device for furniture undersides of the present disclosure;

FIG. 11 is a front view thereof;

FIG. 12 is an enlarged, sectioned front view of the left side of FIG. 11;

FIG. 13 is an enlarged, sectioned front view of the right side of FIG. 11;

FIG. 14 is an enlarged, sectioned rear view of the left side of FIG. 11;

FIG. 15 is an enlarged, sectioned rear view of the right side of FIG. 11;

FIG. 16 is an enlarged, sectioned bottom view of the left side of FIG. 11;

FIG. 17 is an enlarged, sectioned bottom view of the right side of FIG. 11; and,

FIG. 18 is an enlarged side view of the left or right side of FIG. 11.

The dashed lines in FIGS. 1 and 10 depicting a piece of furniture are for environmental purposes only and form no part of the claimed design. The object blocking device is shown in FIGS. 10 and 11 with a symbolic break in its length. The appearance of any portion of the article between the break lines in FIGS. 10 and 11 forms no part of the claimed design.

**1 Claim, 8 Drawing Sheets**

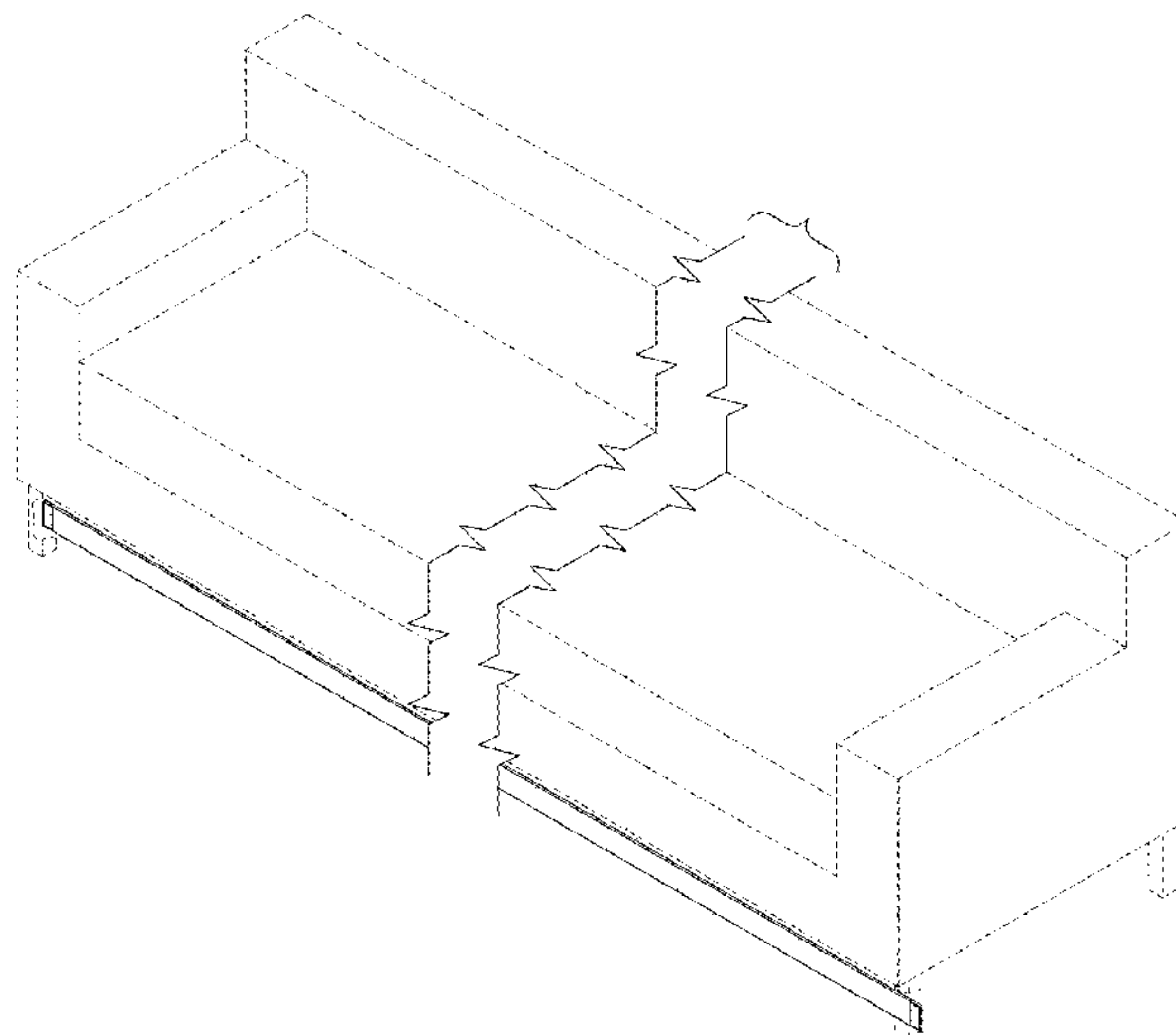



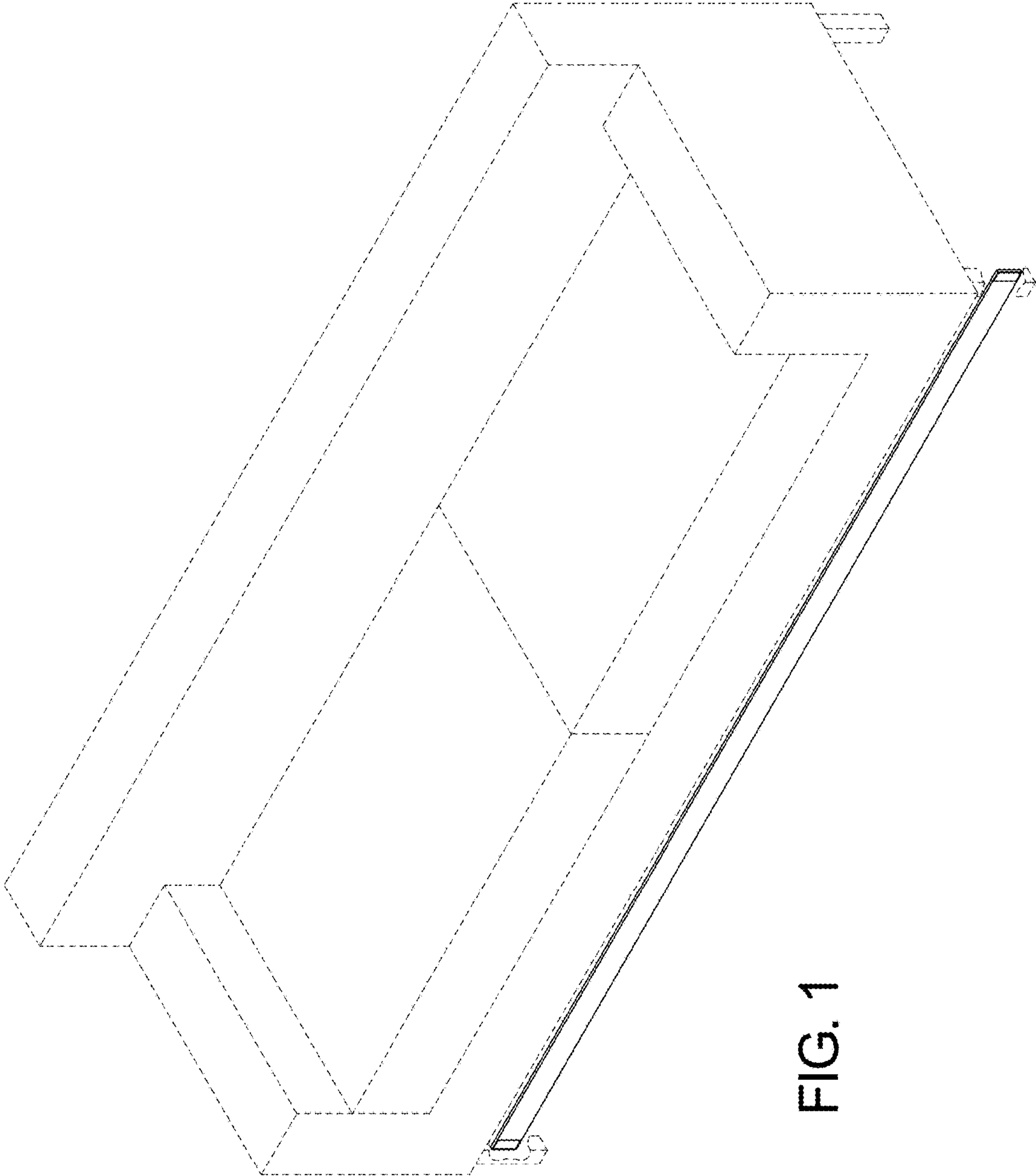
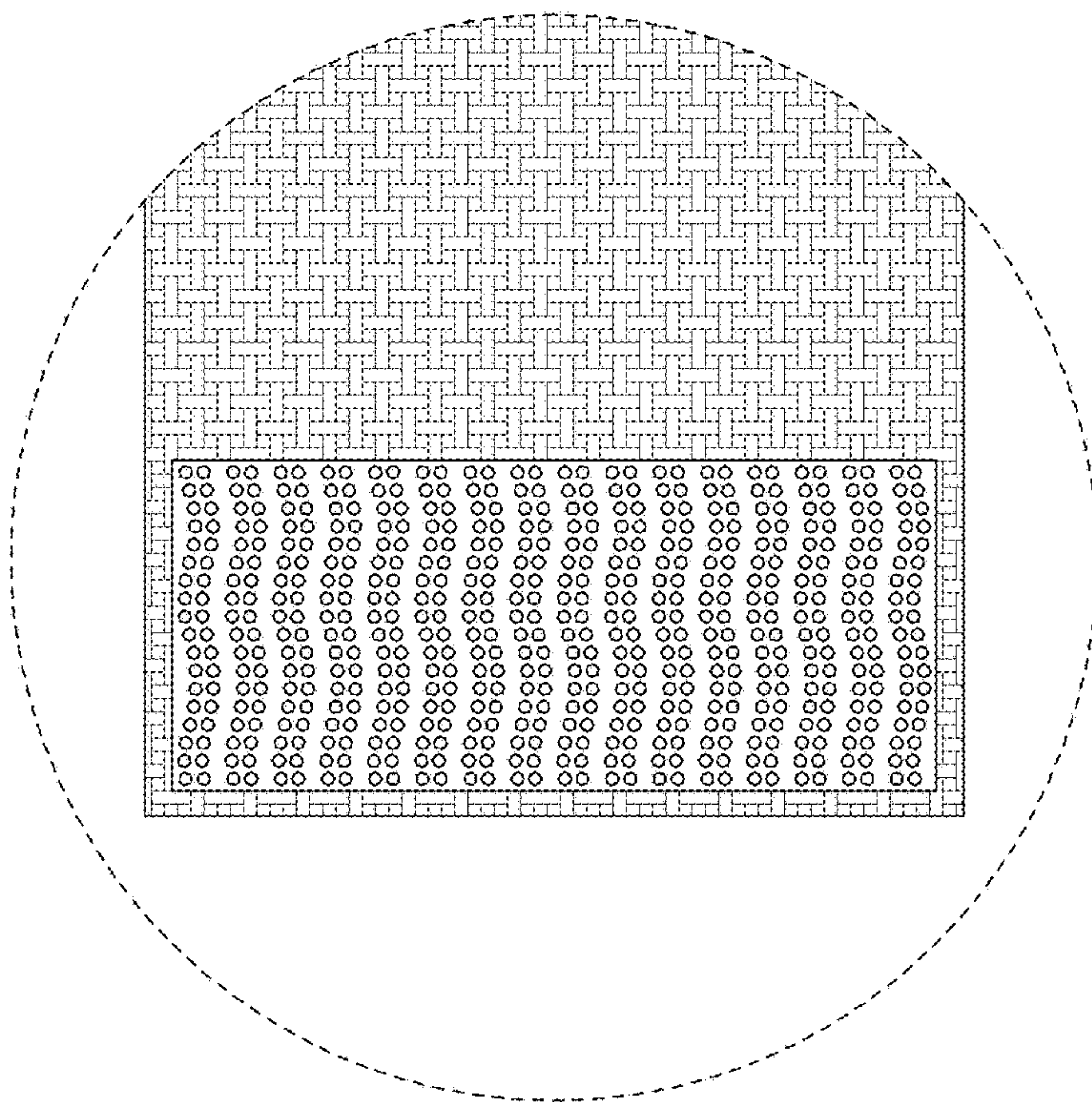
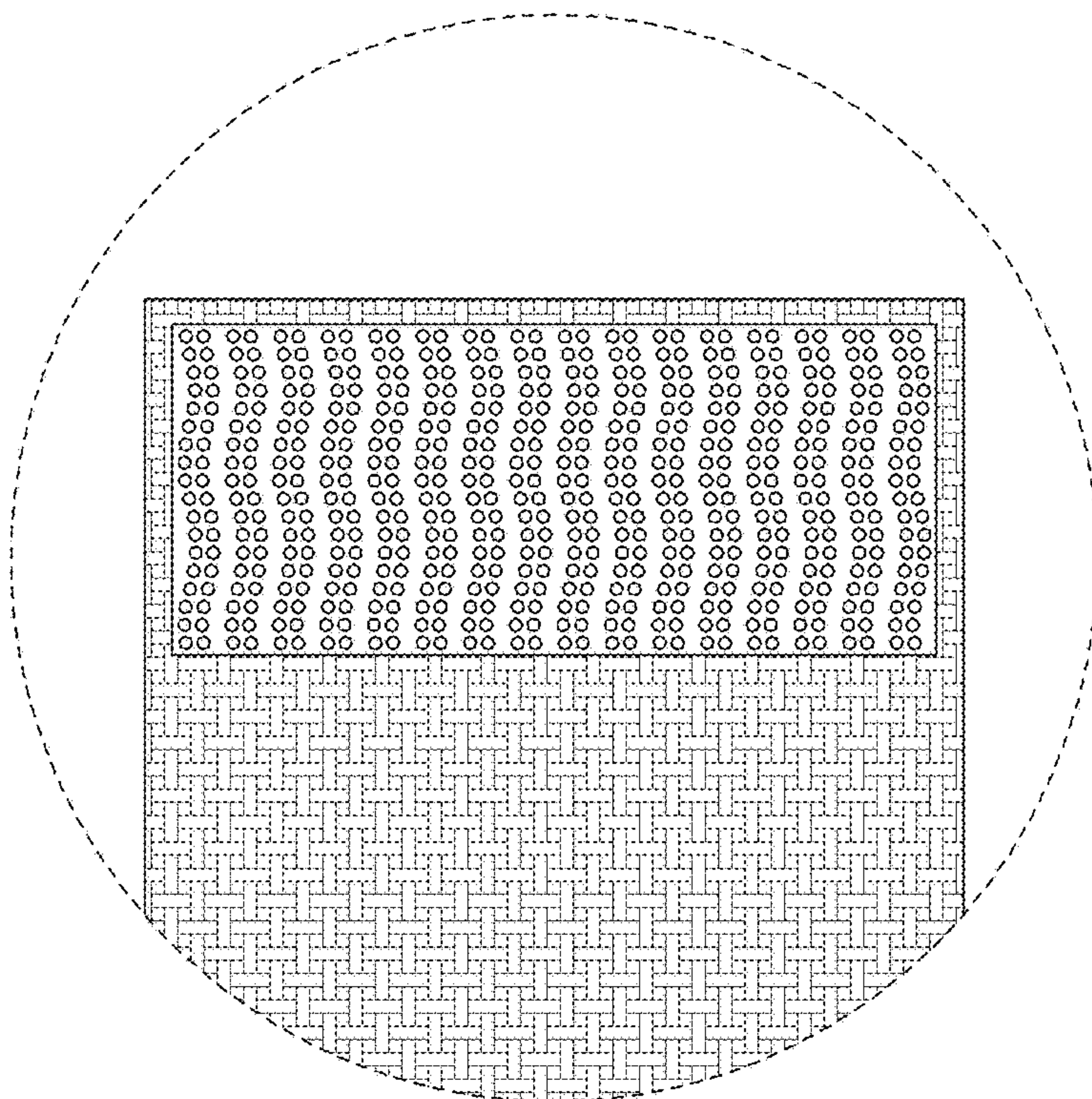
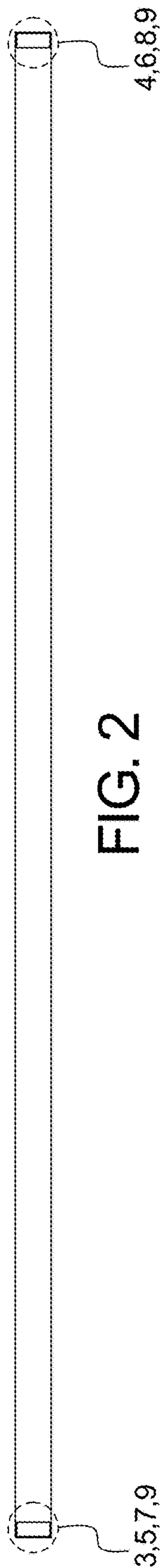

FIG. 1





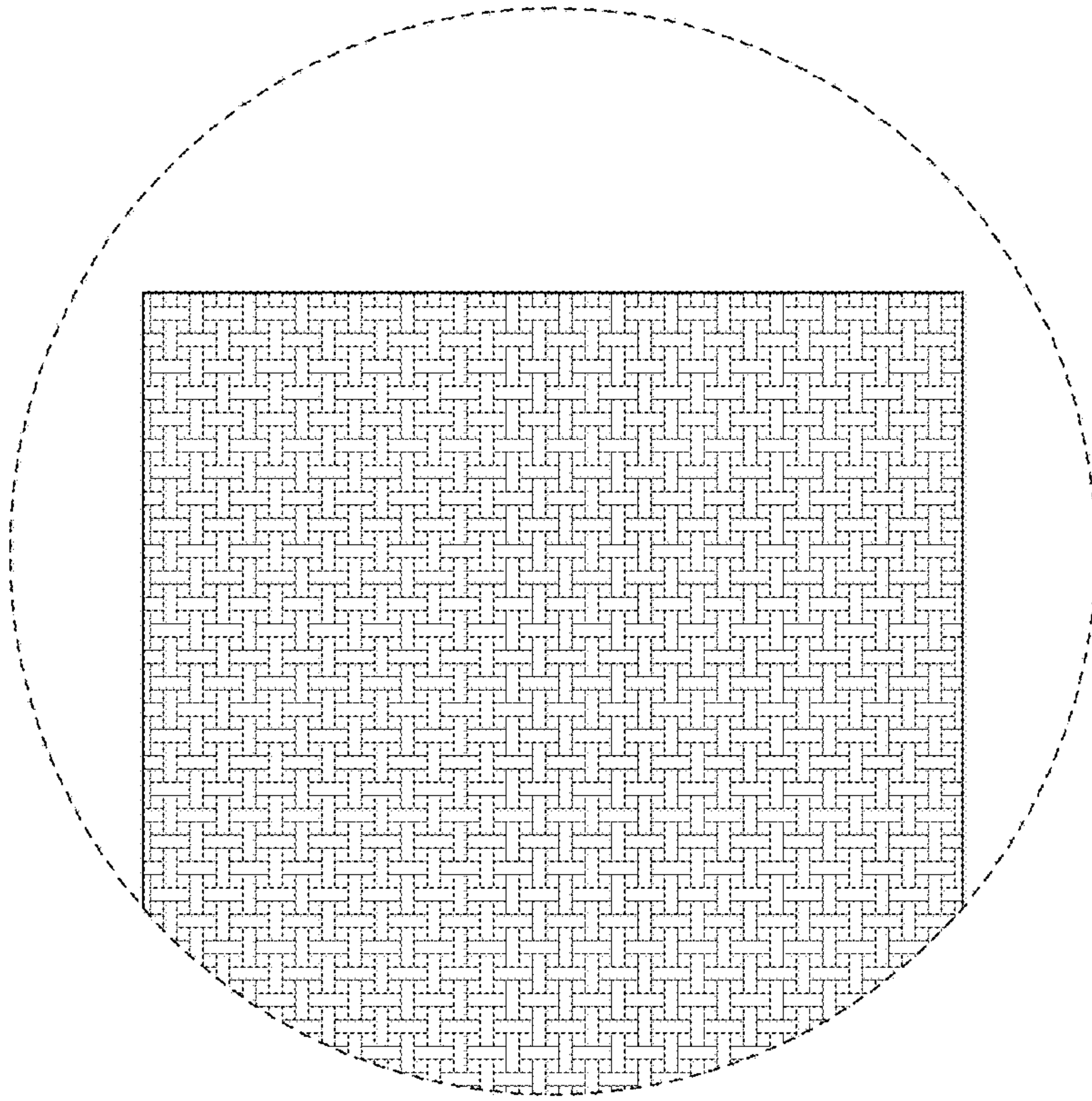

FIG. 6

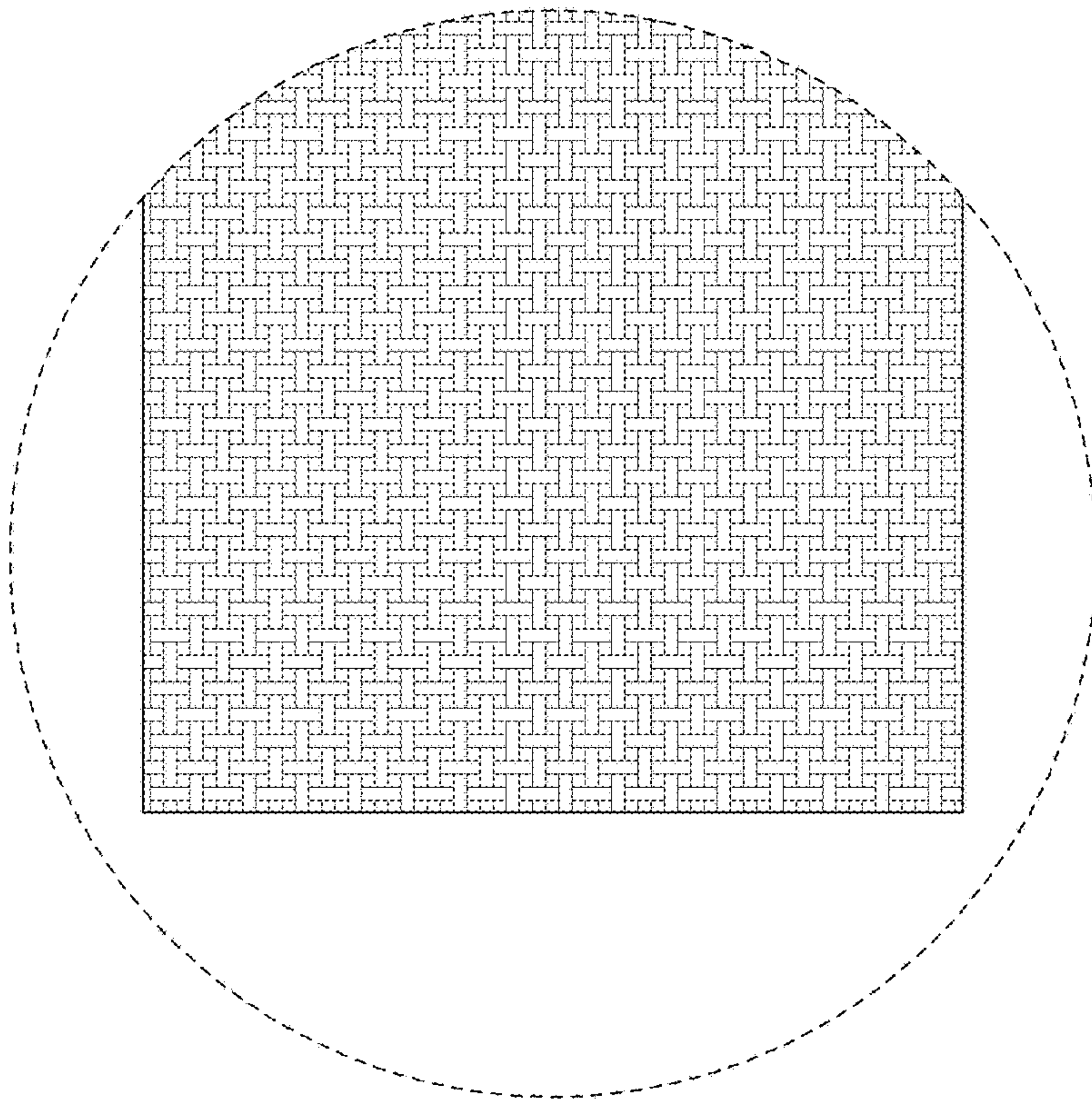

FIG. 5



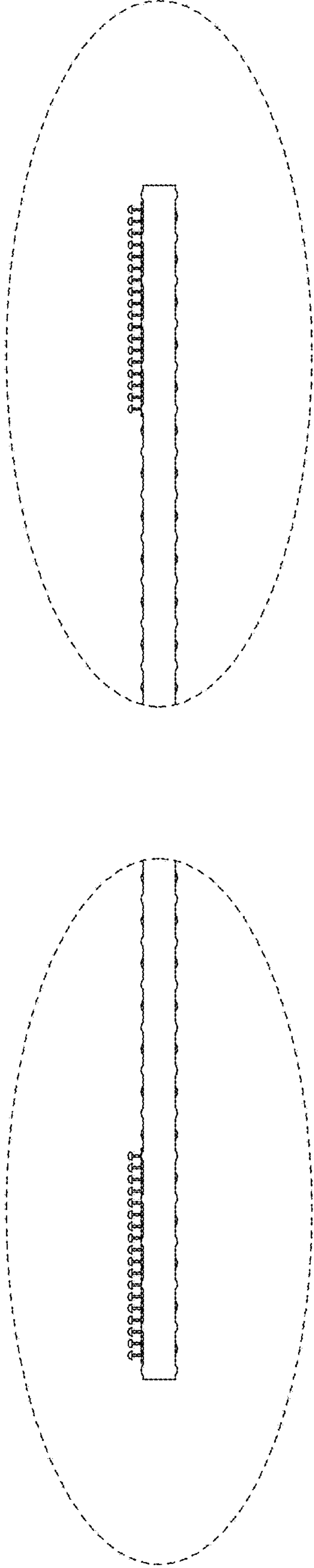

FIG. 7

FIG. 8

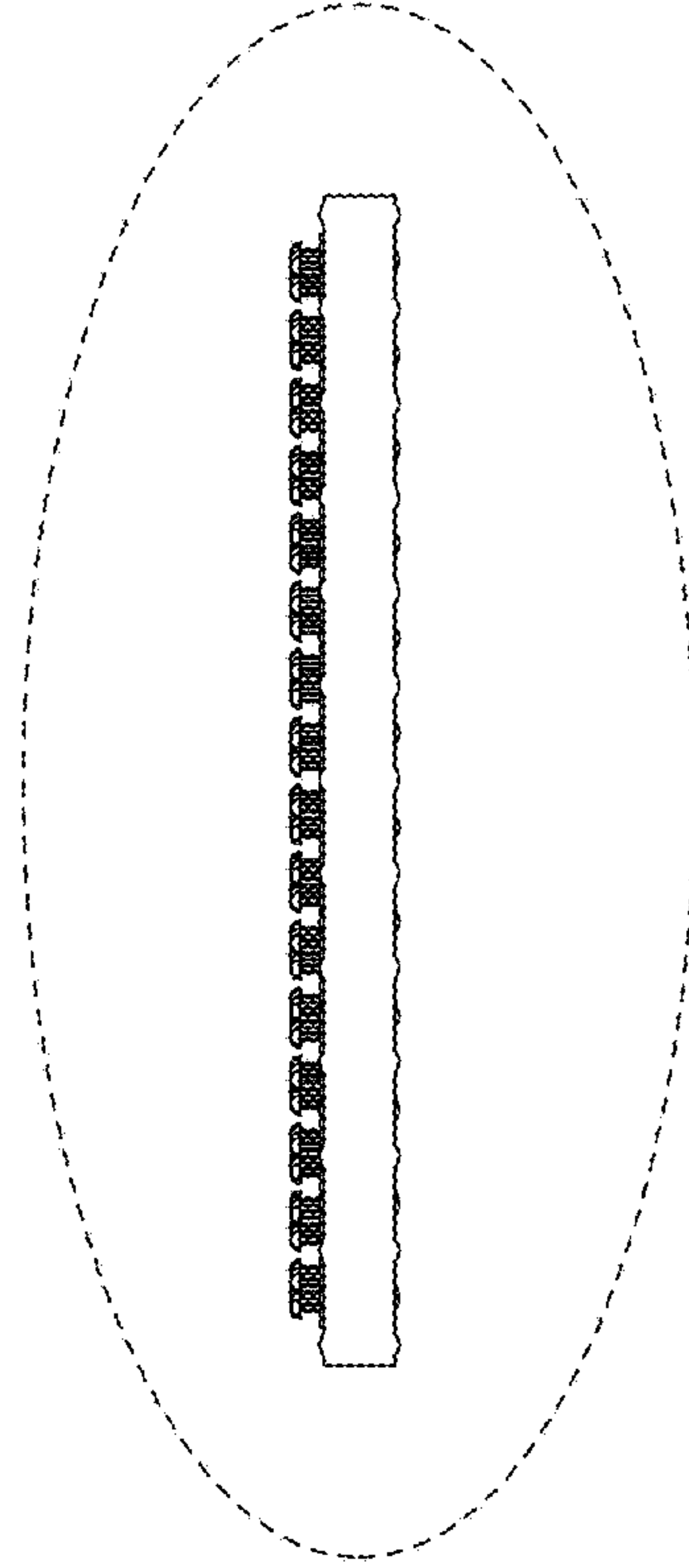

FIG. 9

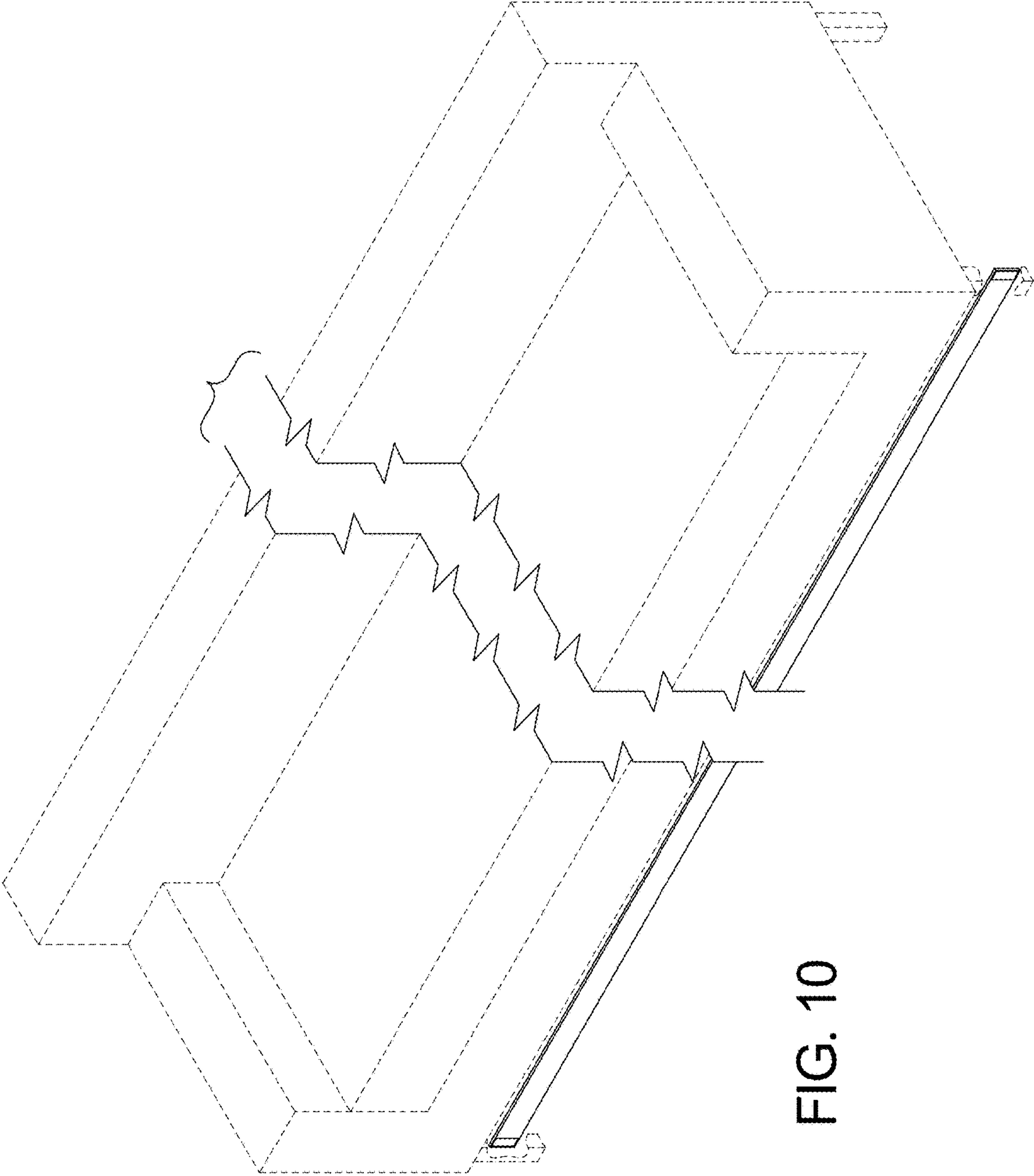
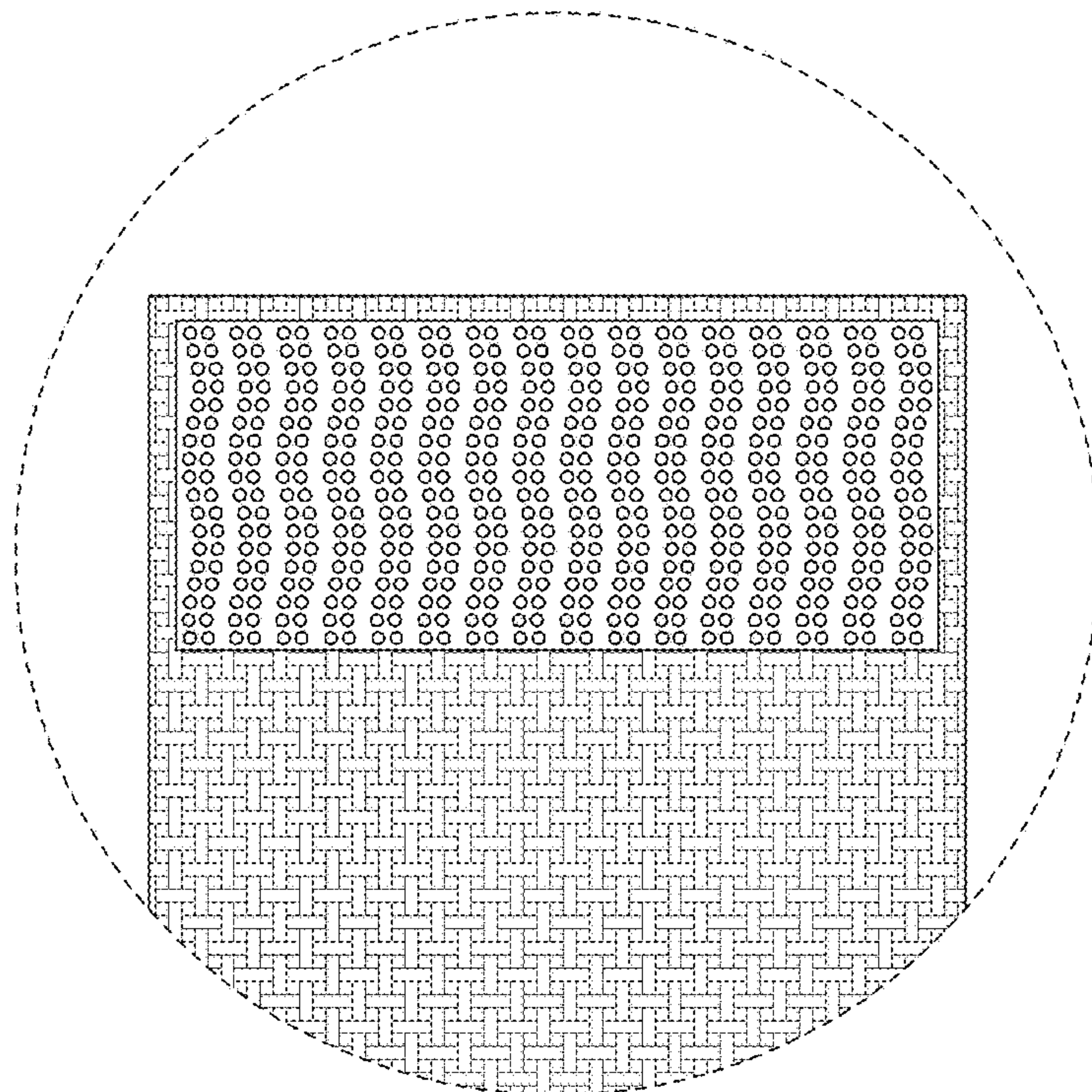
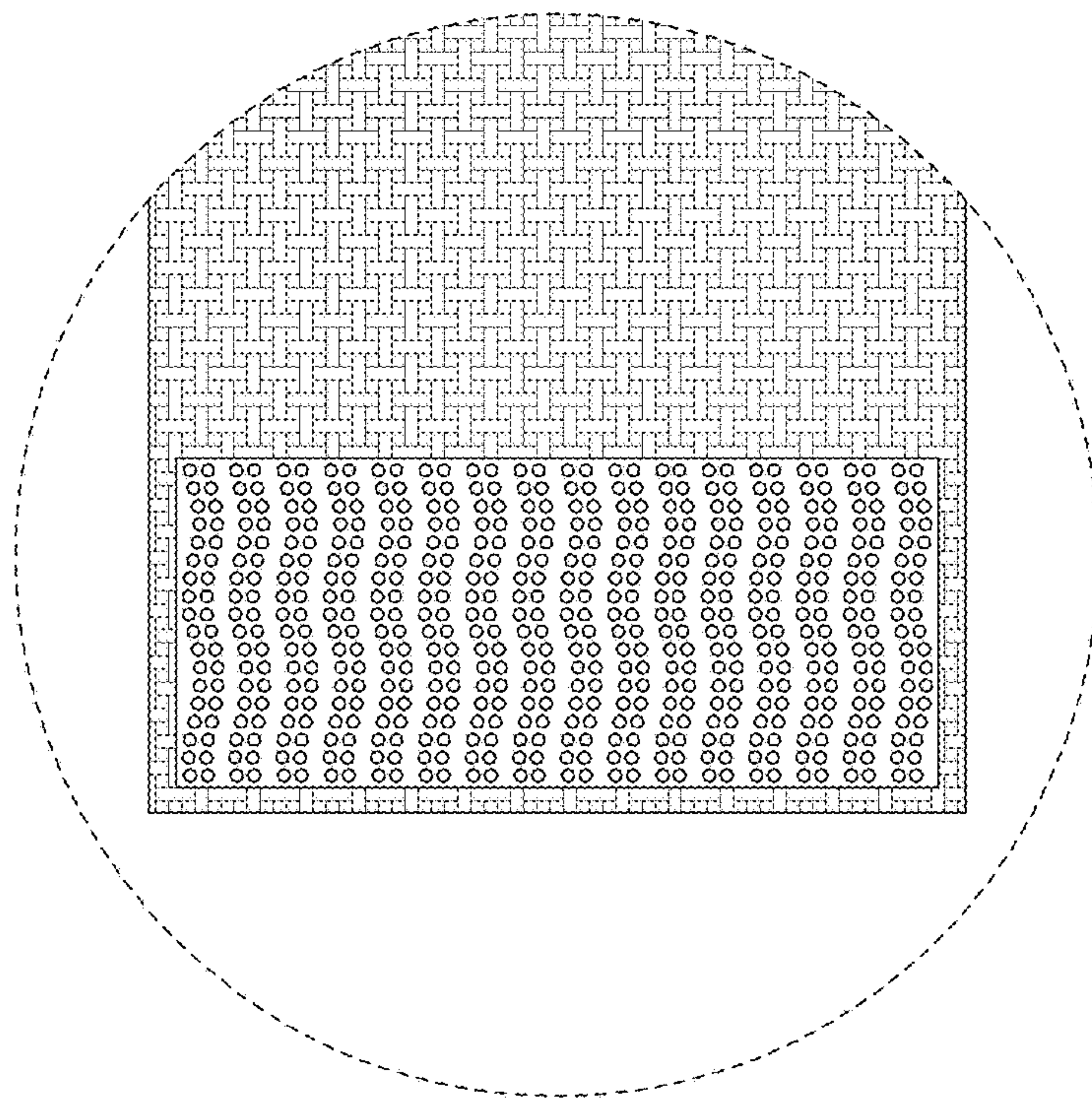
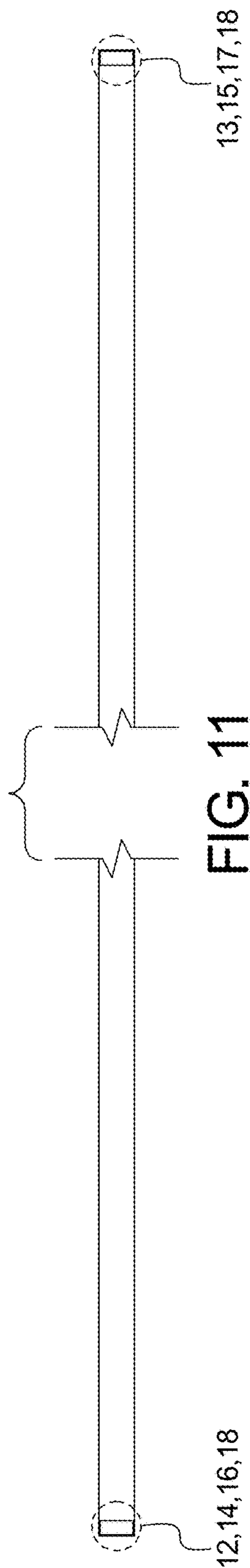

FIG. 10





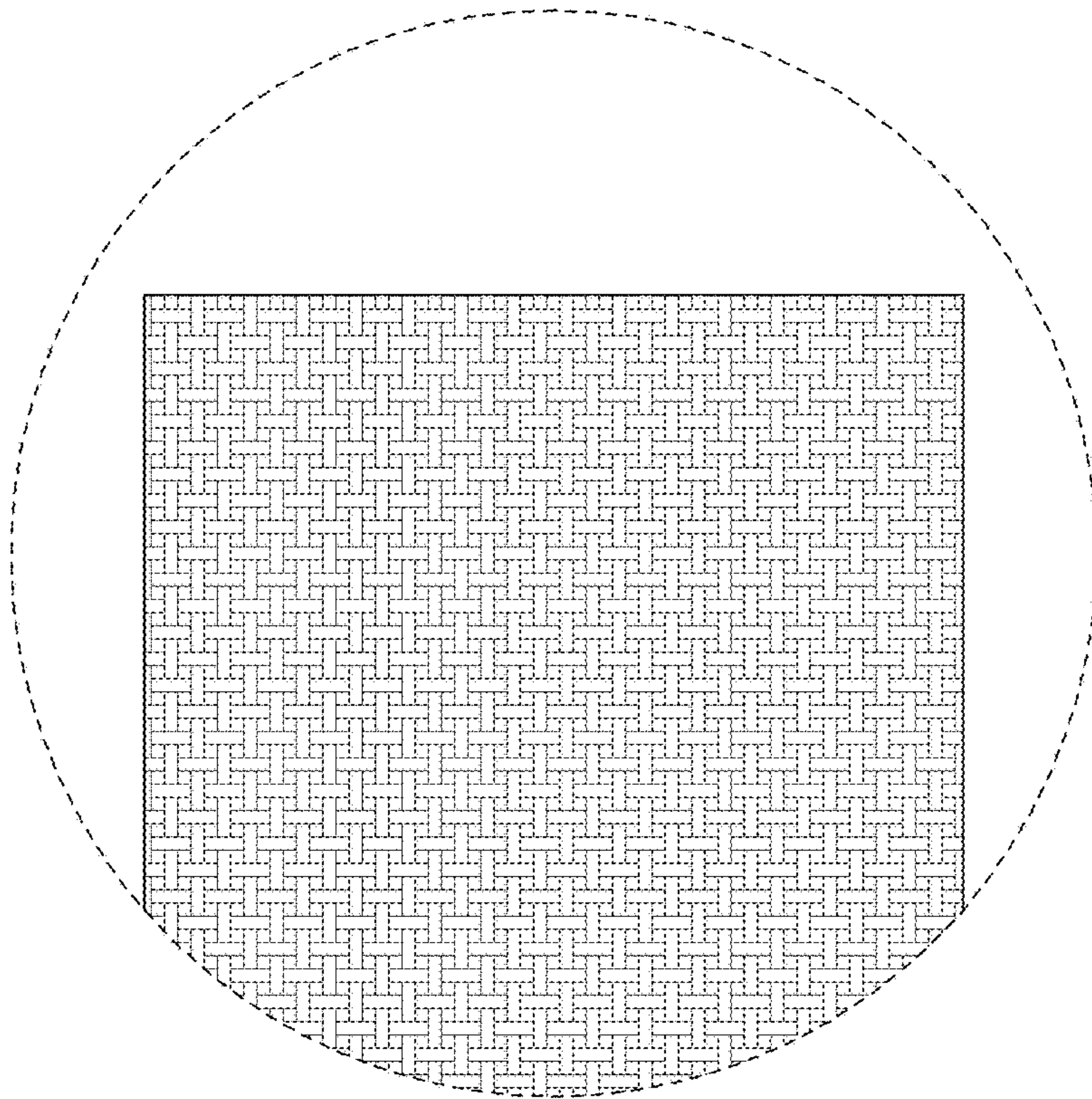

FIG. 15

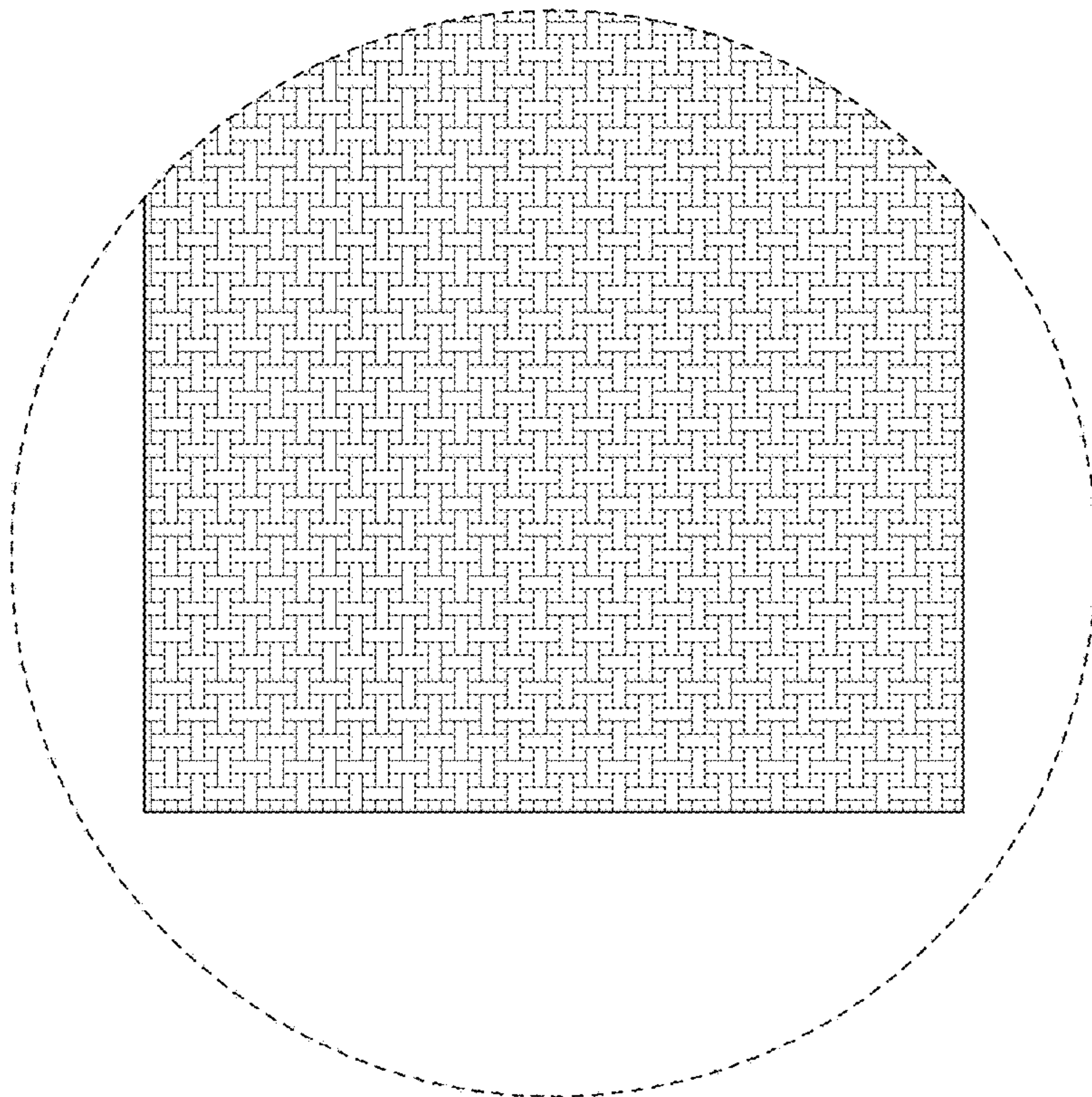

FIG. 14

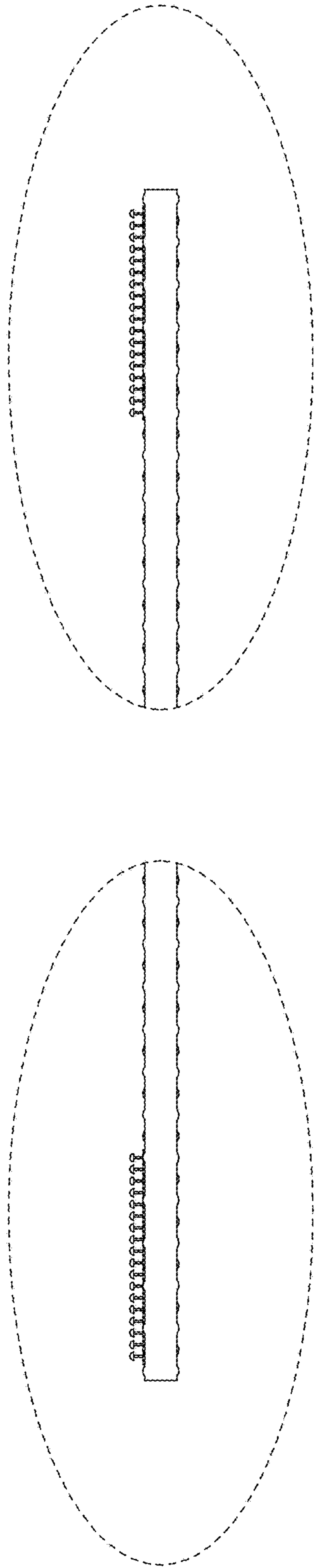

FIG. 16

FIG. 17

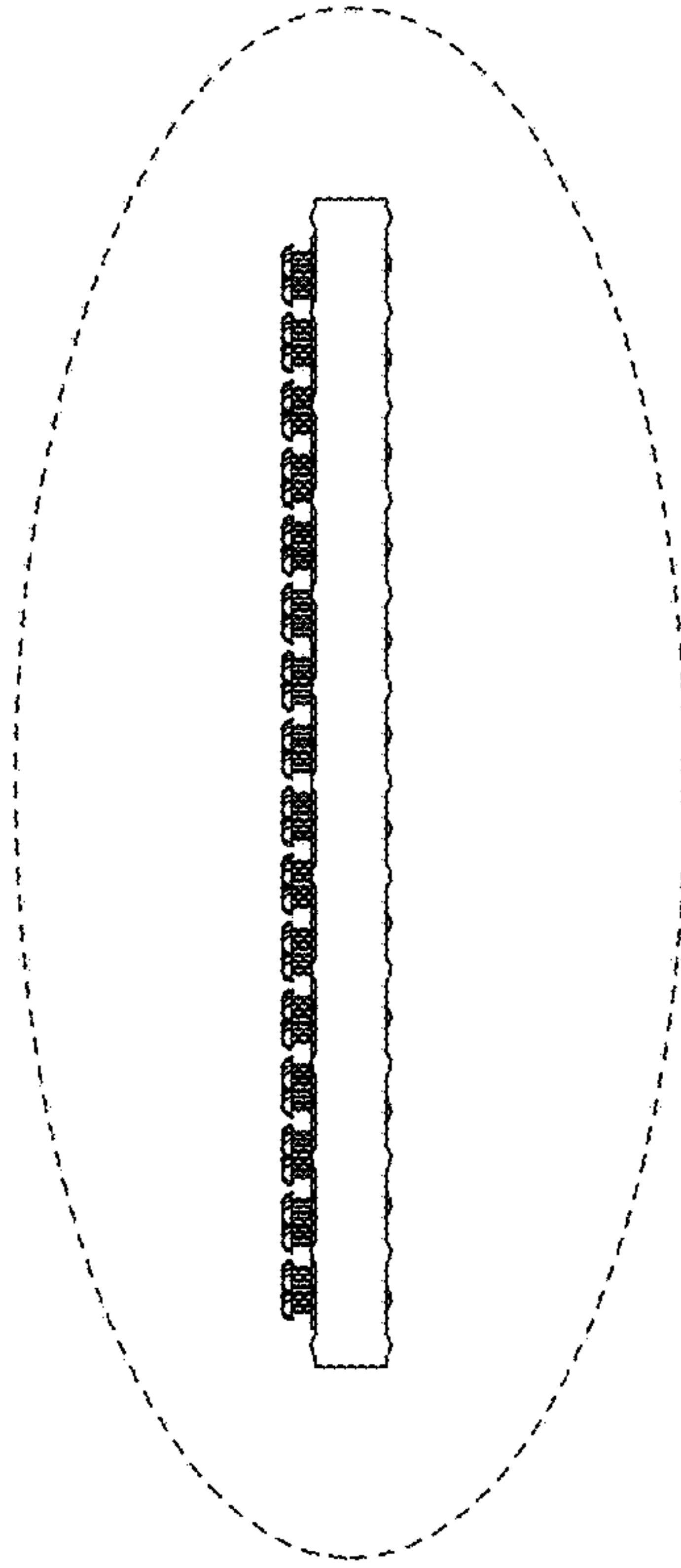

FIG. 18