



US00D791992S

(12) **United States Design Patent** (10) **Patent No.:** **US D791,992 S**  
**Hsu** (45) **Date of Patent:** **\*\* Jul. 11, 2017**

(54) **PORTABLE LIGHT**  
(71) Applicant: **Ching-Feng Hsu**, New Taipei (TW)  
(72) Inventor: **Ching-Feng Hsu**, New Taipei (TW)  
(\*\*) Term: **15 Years**  
(21) Appl. No.: **29/532,310**  
(22) Filed: **Jul. 6, 2015**  
(51) **LOC (10) Cl.** ..... **26-02**  
(52) **U.S. Cl.**  
USPC ..... **D26/41**  
(58) **Field of Classification Search**  
USPC ..... D26/37, 39, 40, 41, 42, 43, 44, 46, 50,  
D26/63; 362/157, 158, 183, 184,  
362/194–196, 200–208, 253  
CPC ..... F21L 2003/00; F21L 4/00; F21L 4/005;  
F21L 4/02; F21L 4/025; F21L 4/027;  
F21L 4/04; F21L 4/08; F21L 2005/00;  
F21L 7/00; F21L 11/00; F21L 13/00;  
F21L 13/04; F21L 13/08; F21L 14/02;  
F21L 17/00  
See application file for complete search history.

D693,500 S \* 11/2013 Souvay ..... D26/44  
D711,572 S \* 8/2014 Kwon ..... D26/37  
D716,481 S \* 10/2014 Jacobs ..... D26/41  
D718,480 S \* 11/2014 Lee ..... D26/41  
D729,428 S \* 5/2015 Shen ..... D26/41  
D752,793 S \* 3/2016 Ng ..... D26/48

\* cited by examiner

*Primary Examiner* — Lakiya Rogers  
*Assistant Examiner* — Carissa C Fitts  
(74) *Attorney, Agent, or Firm* — The Weintraub Group,  
P.L.C.

(57) **CLAIM**  
The ornamental design for a portable light, as shown and described.

**DESCRIPTION**

FIG. 1 is a perspective view of a portable light showing my new design;  
FIG. 2 is a front view thereof;  
FIG. 3 is a rear view thereof;  
FIG. 4 is a left side view thereof;  
FIG. 5 is a right side view thereof;  
FIG. 6 is a top view thereof;  
FIG. 7 is a bottom view thereof;  
FIG. 8 is another perspective view thereof;  
FIG. 9 is a perspective view thereof showing that a lighting module of the portable light in FIG. 8 starts to turn;  
FIG. 10 is a perspective view thereof showing that the lighting module of the portable light in FIG. 9 further turns halfway; and,  
FIG. 11 is a perspective view thereof showing that the lighting module of the portable light in FIG. 10 further turns over completely.  
The broken lines shown represent unclaimed portions of the article and form no part of the claimed design.

(56) **References Cited**  
U.S. PATENT DOCUMENTS  
D225,262 S \* 11/1972 Houplain ..... D26/65  
D263,000 S \* 2/1982 Heritage ..... D26/131  
D288,135 S \* 2/1987 Donato ..... D26/63  
D407,512 S \* 3/1999 Yuen ..... D26/41  
D479,890 S \* 9/2003 Jacobs ..... D26/40  
D589,192 S \* 3/2009 Sabernig ..... D26/63  
D604,880 S \* 11/2009 Lovegrove ..... D26/63  
D645,593 S \* 9/2011 Janssen ..... D26/63  
D673,316 S \* 12/2012 Oshima ..... D26/50  
D693,499 S \* 11/2013 Bennett ..... D26/37

**1 Claim, 11 Drawing Sheets**

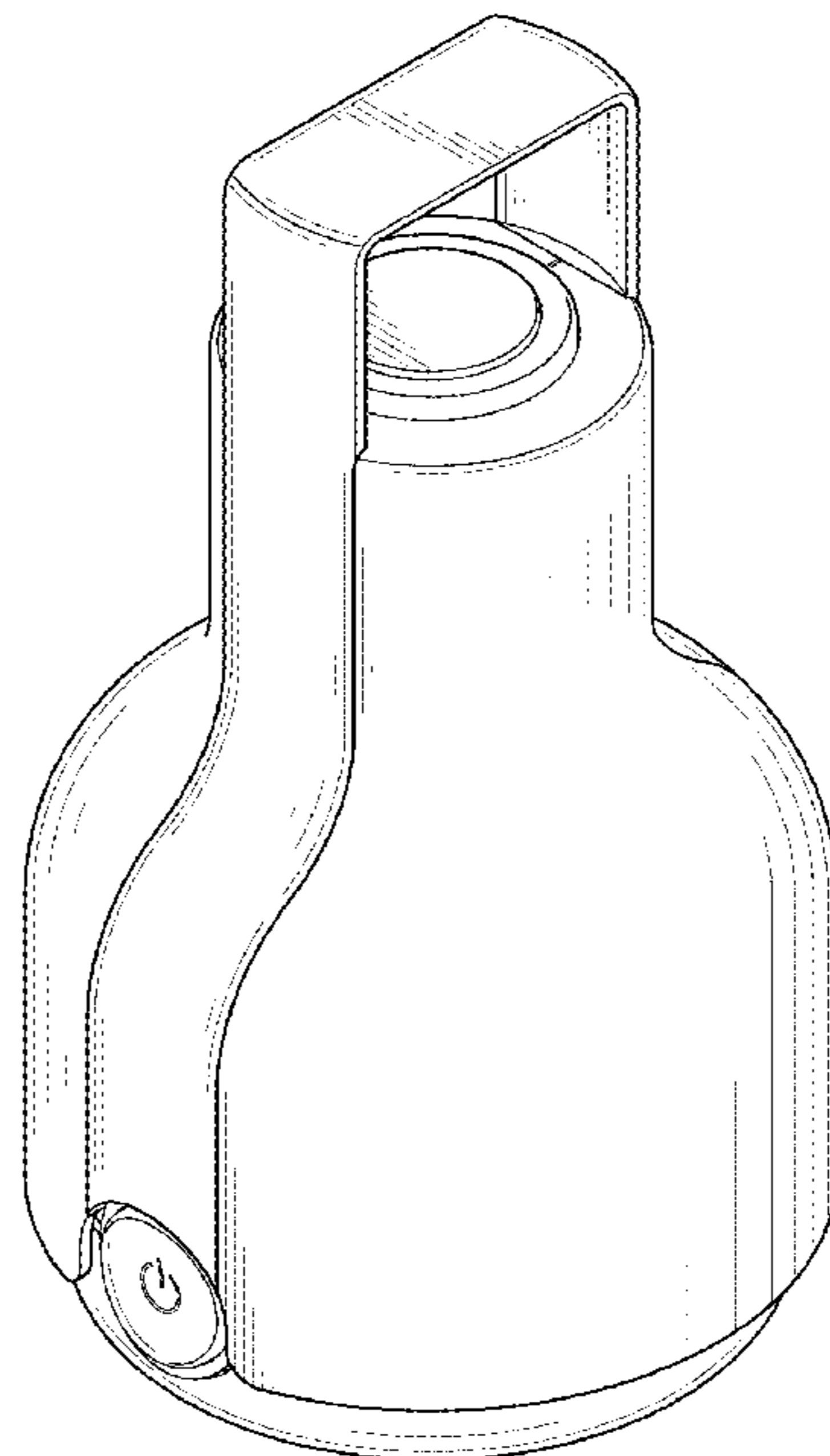

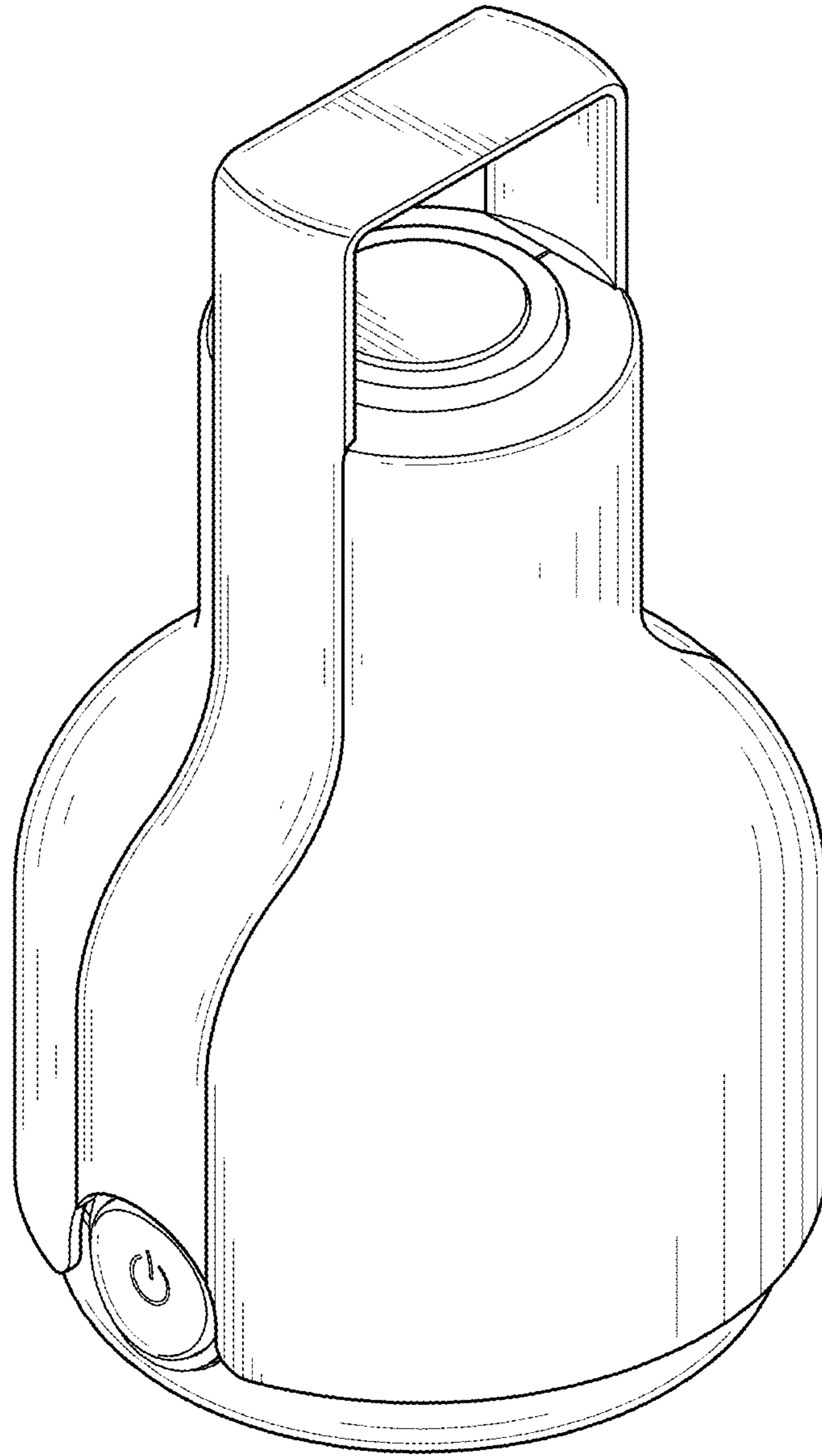

FIG. 1

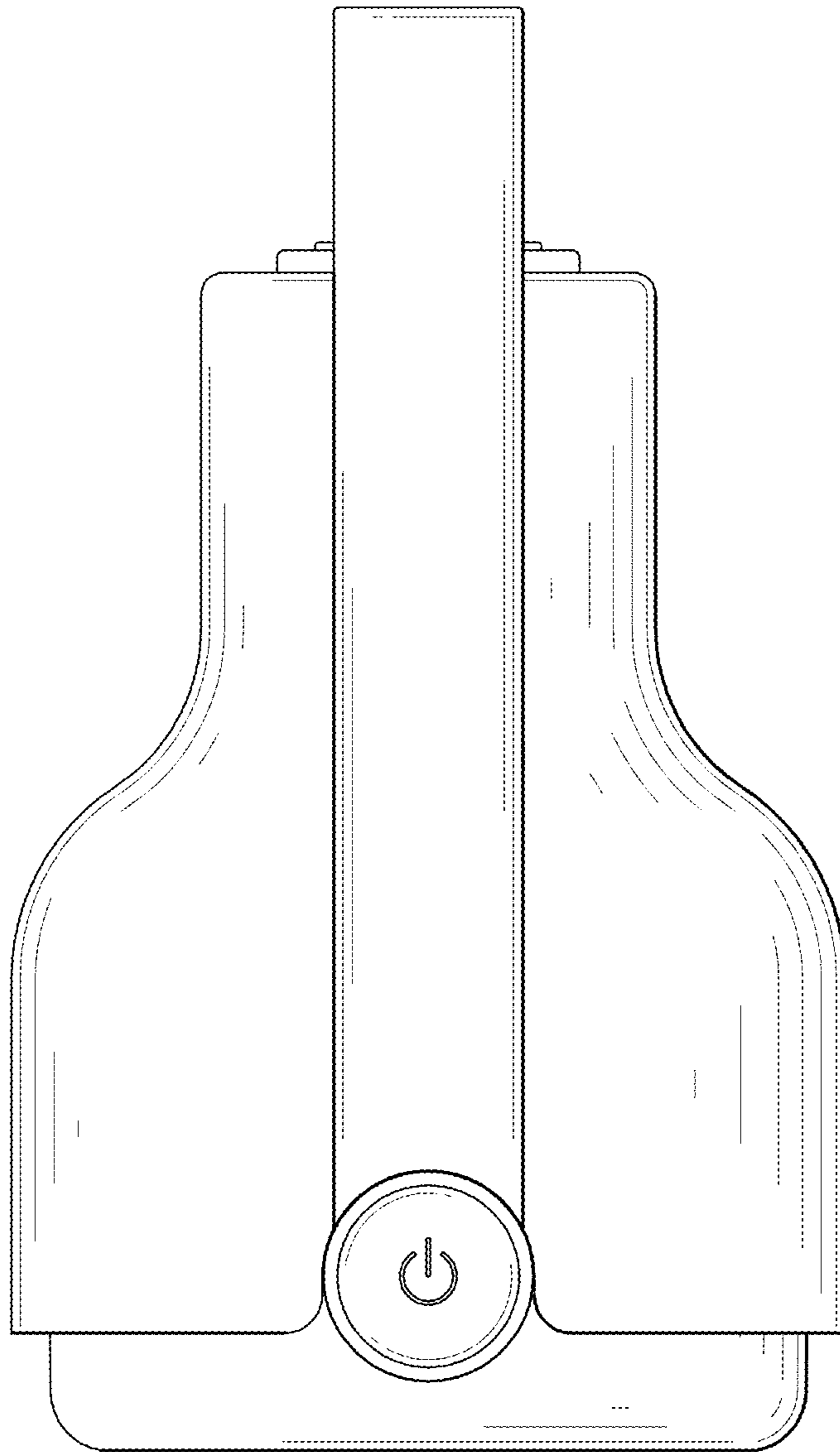

FIG. 2

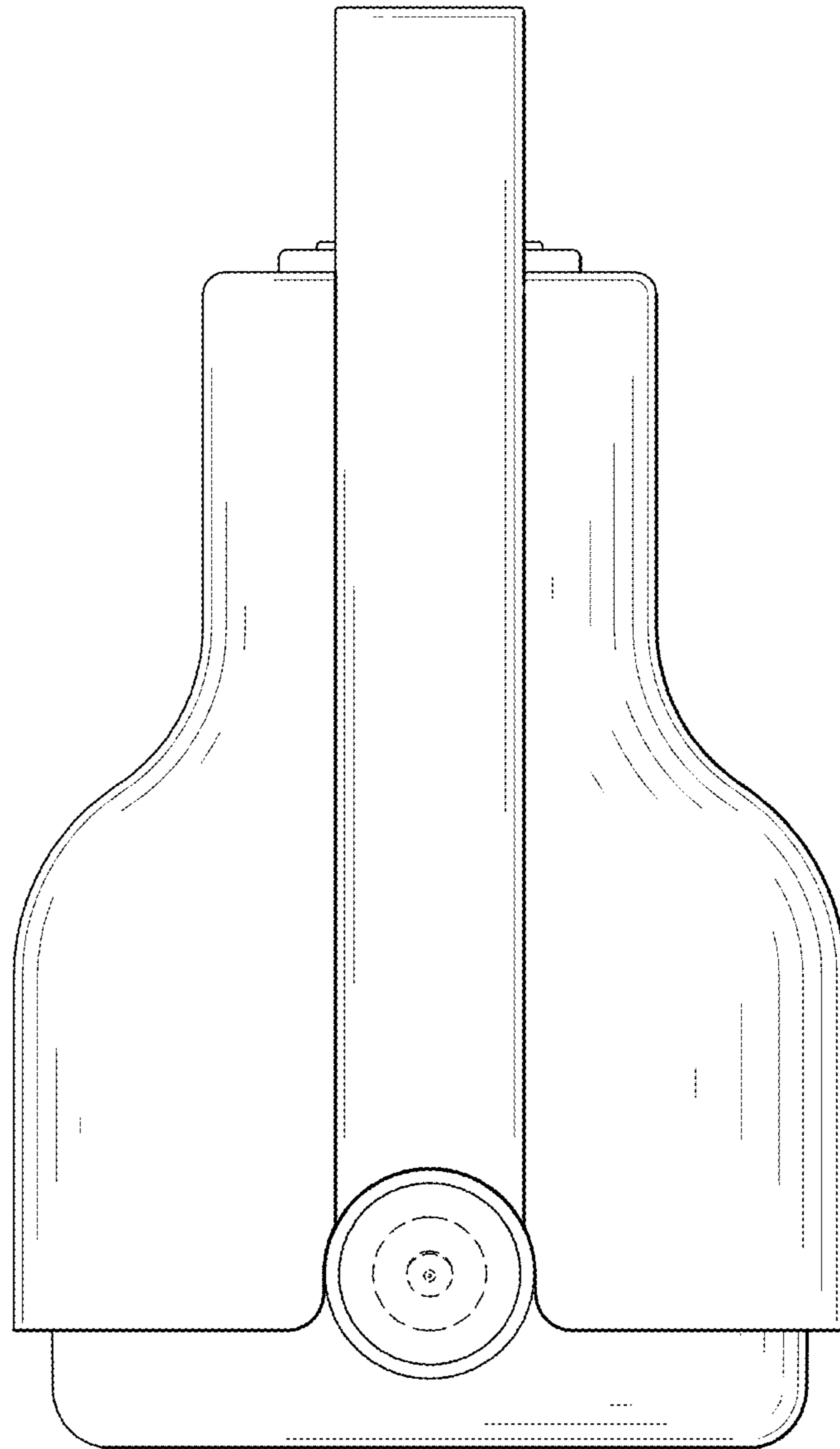

FIG. 3

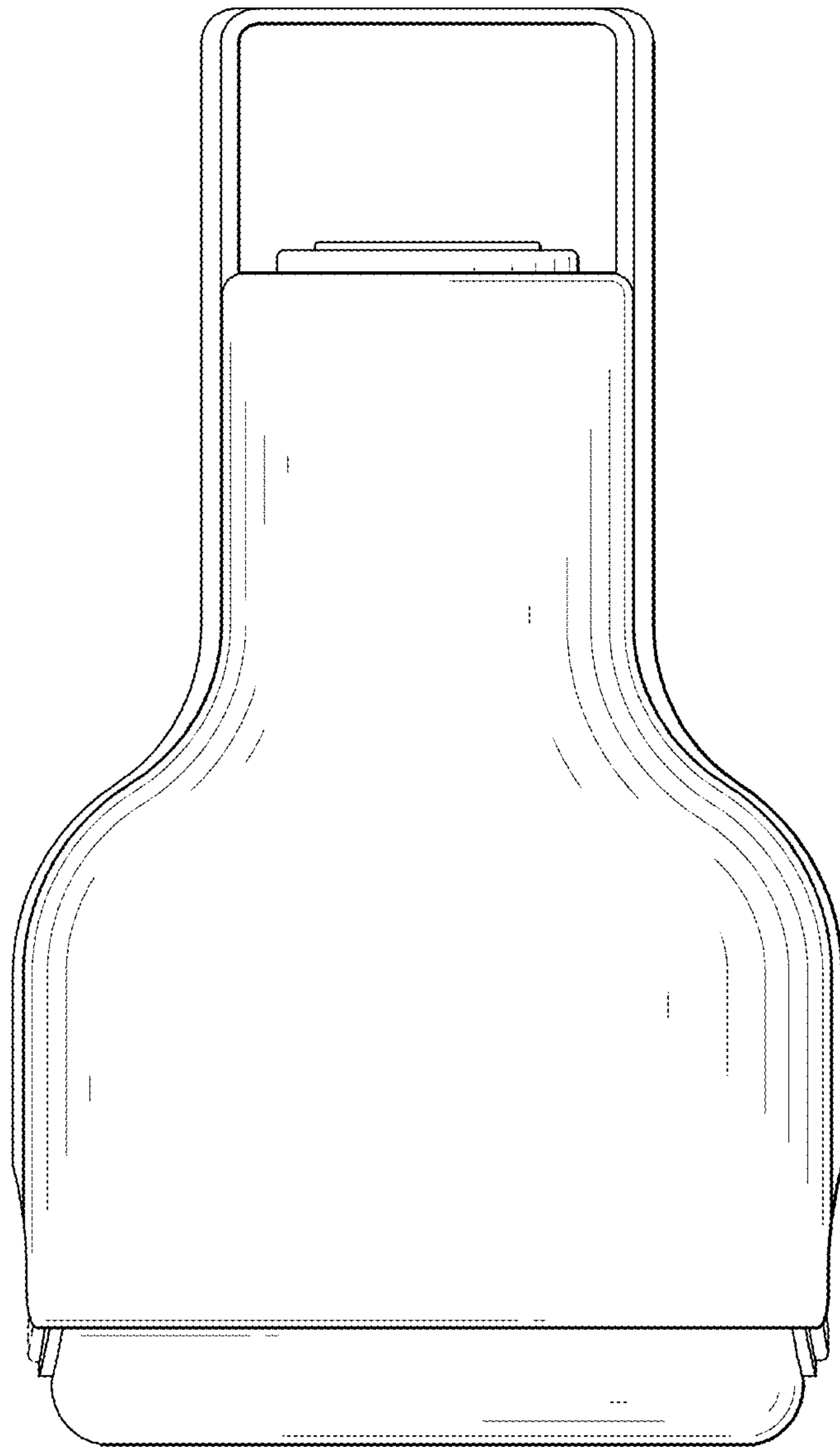

FIG. 4

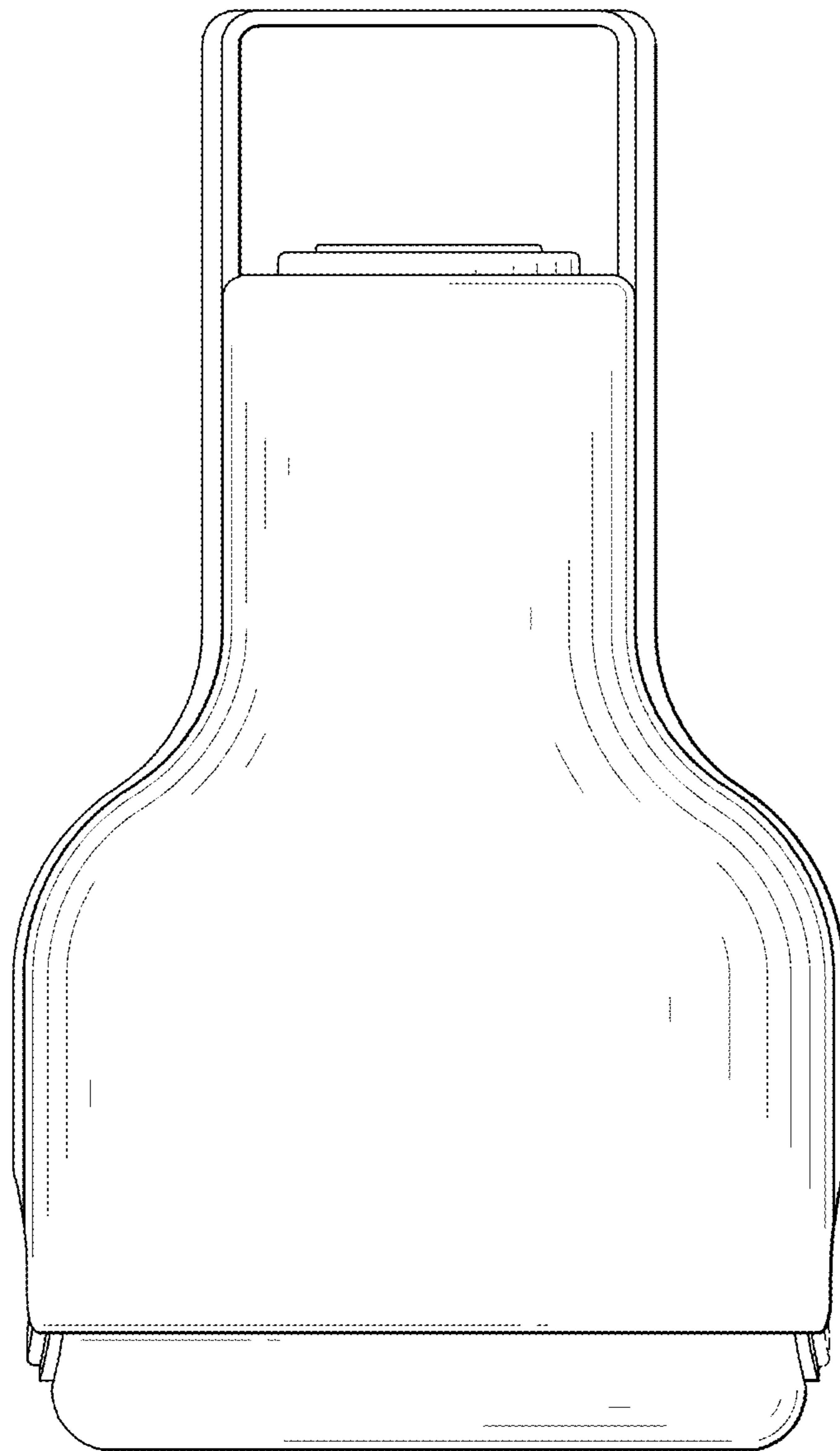

FIG. 5

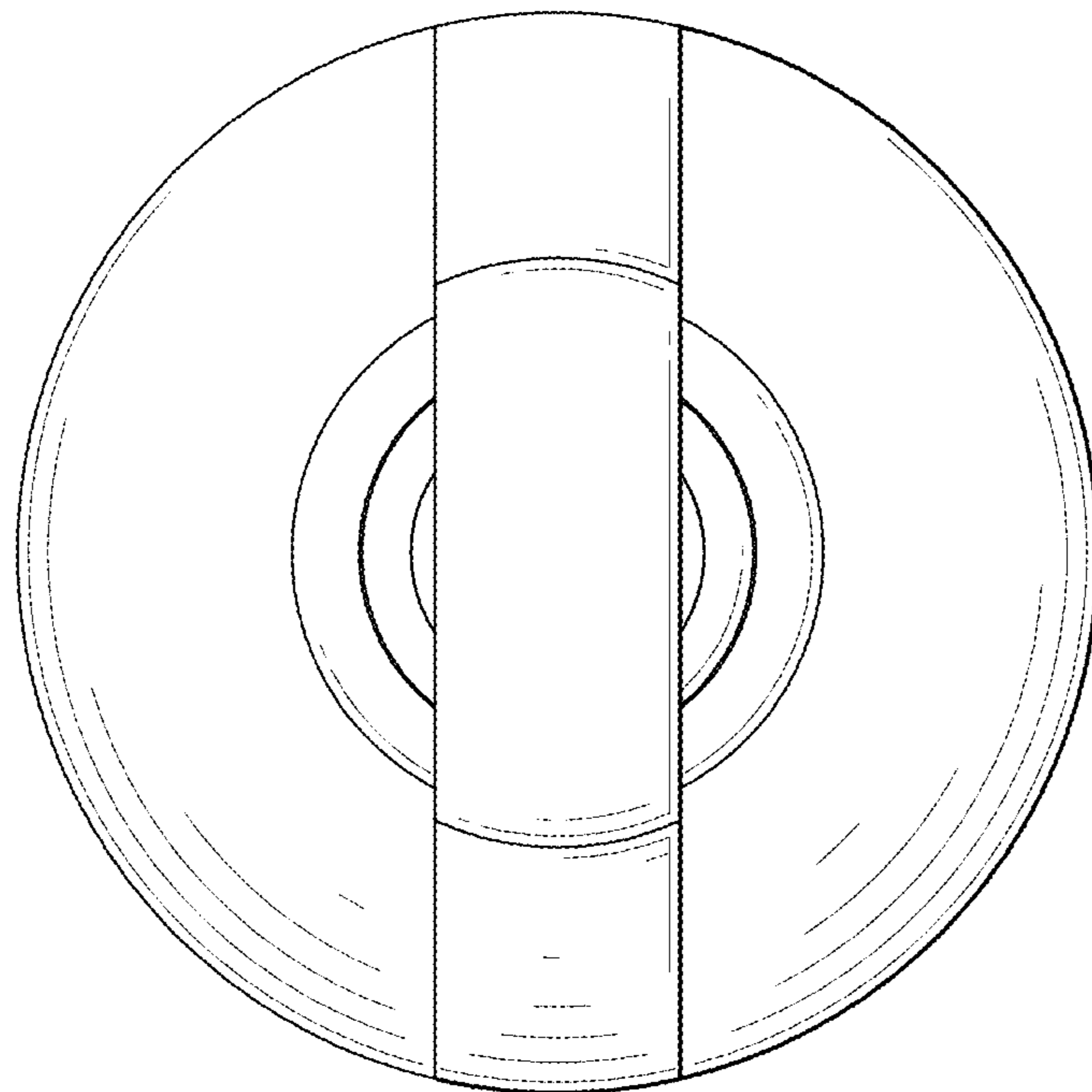

FIG. 6

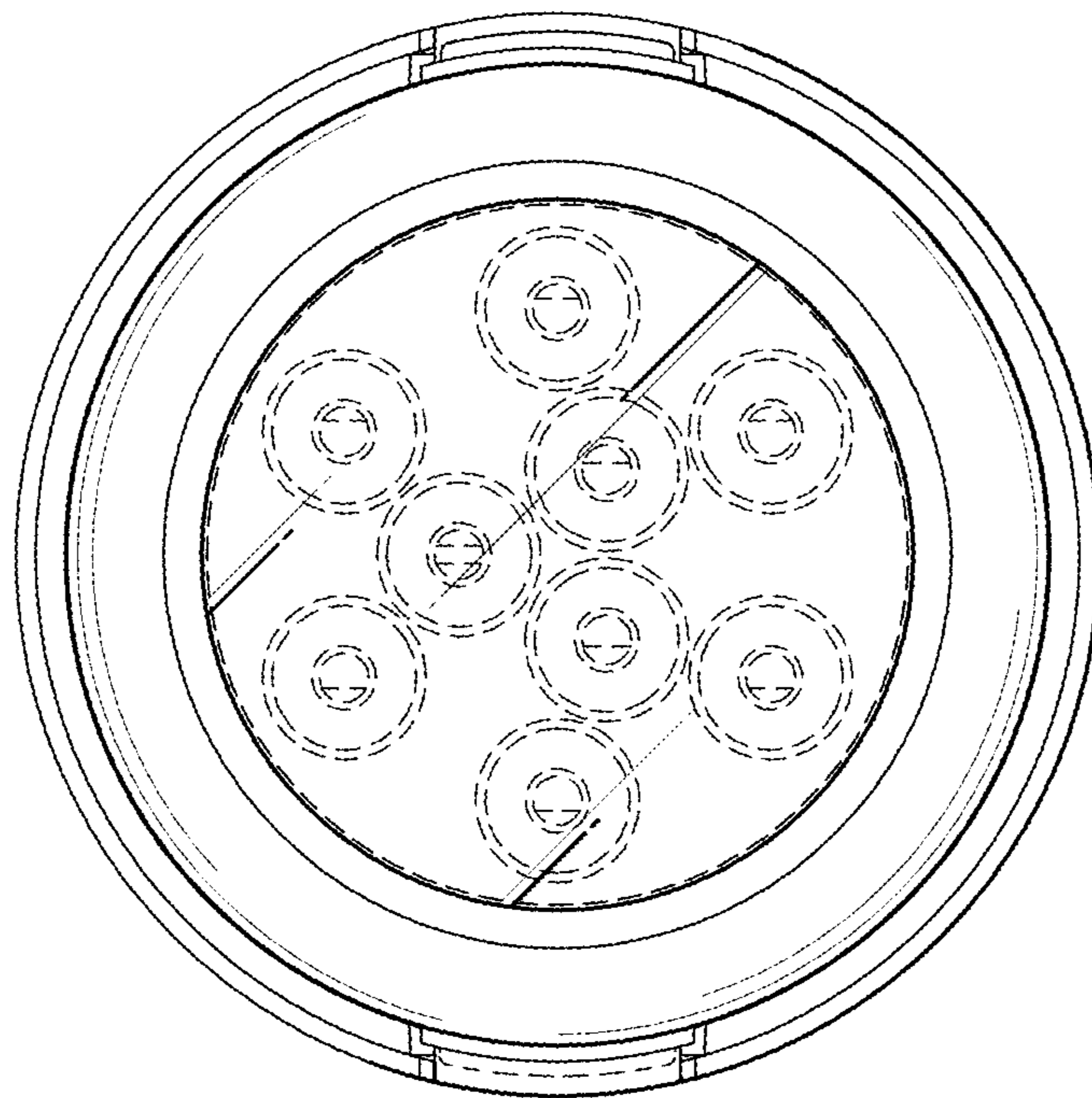

FIG. 7



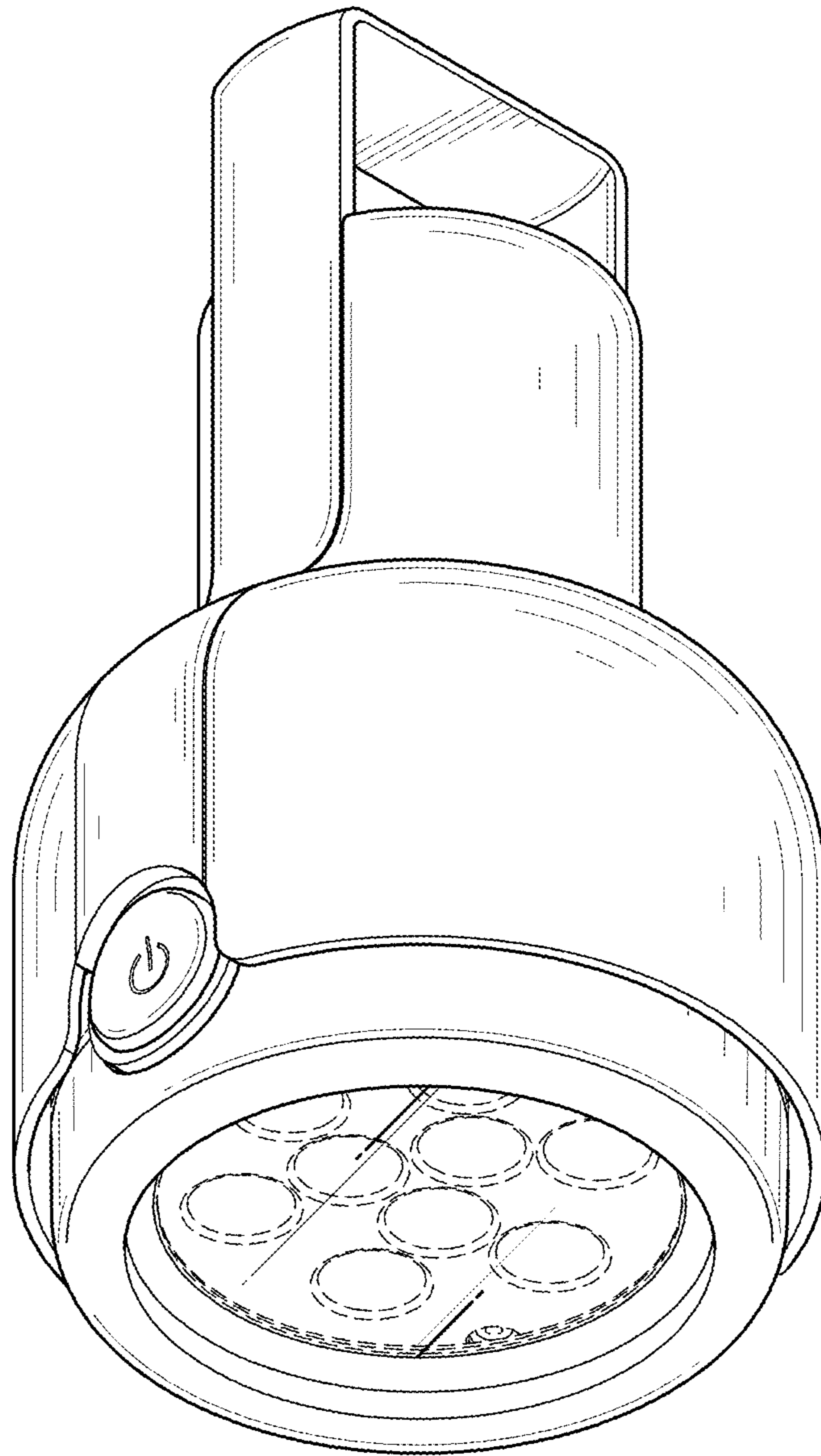

FIG. 8

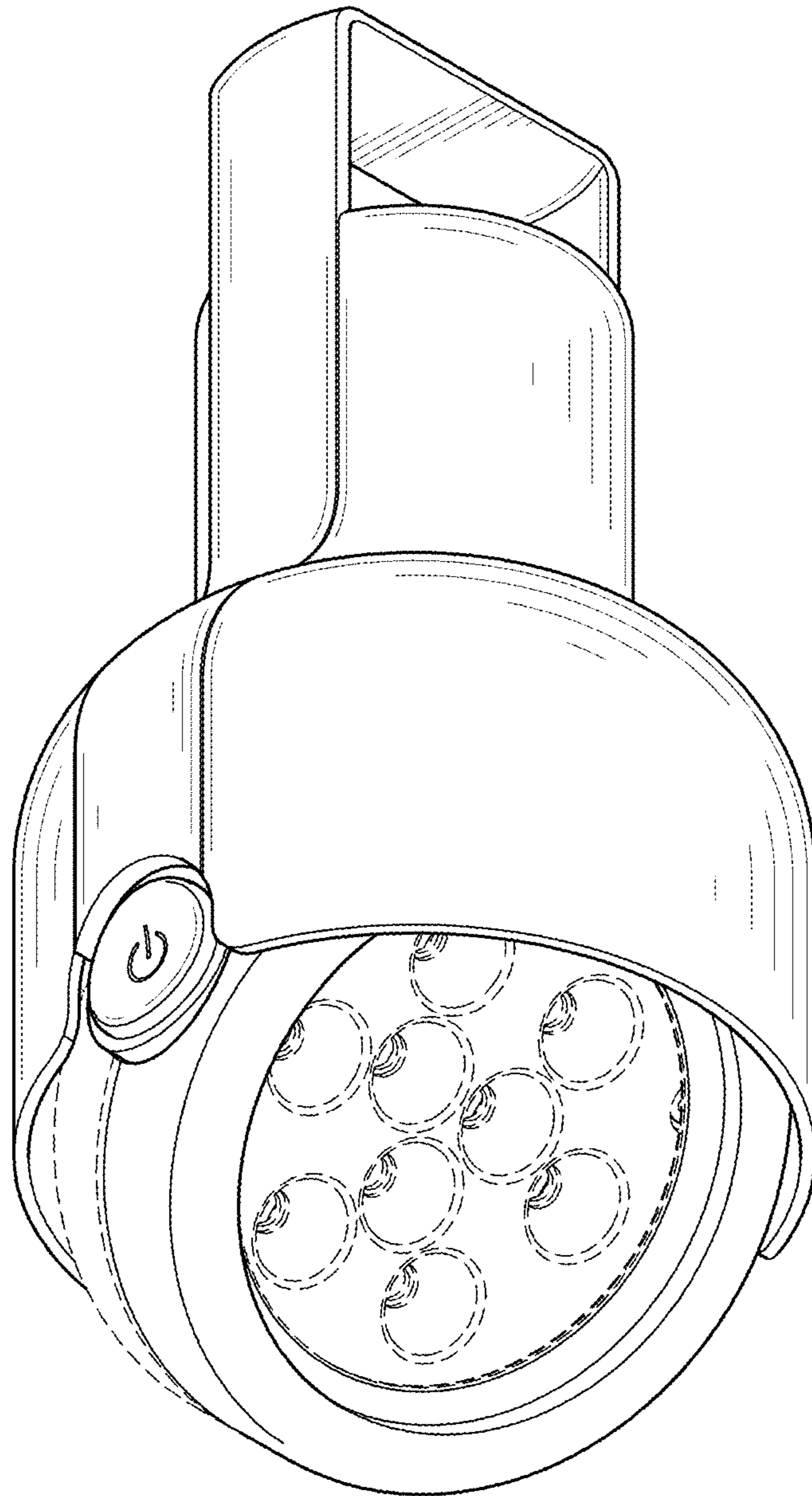

FIG. 9

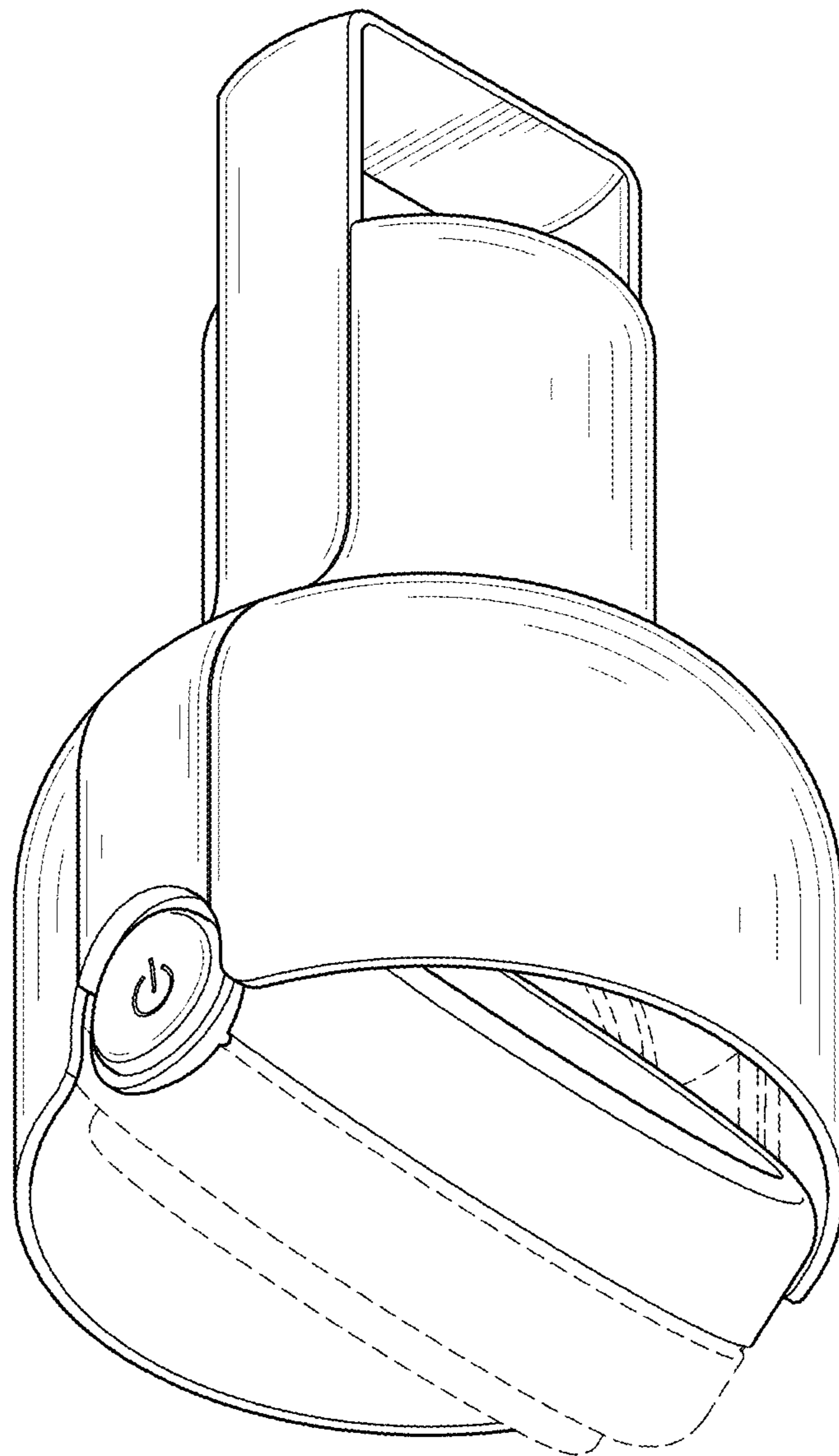

FIG. 10

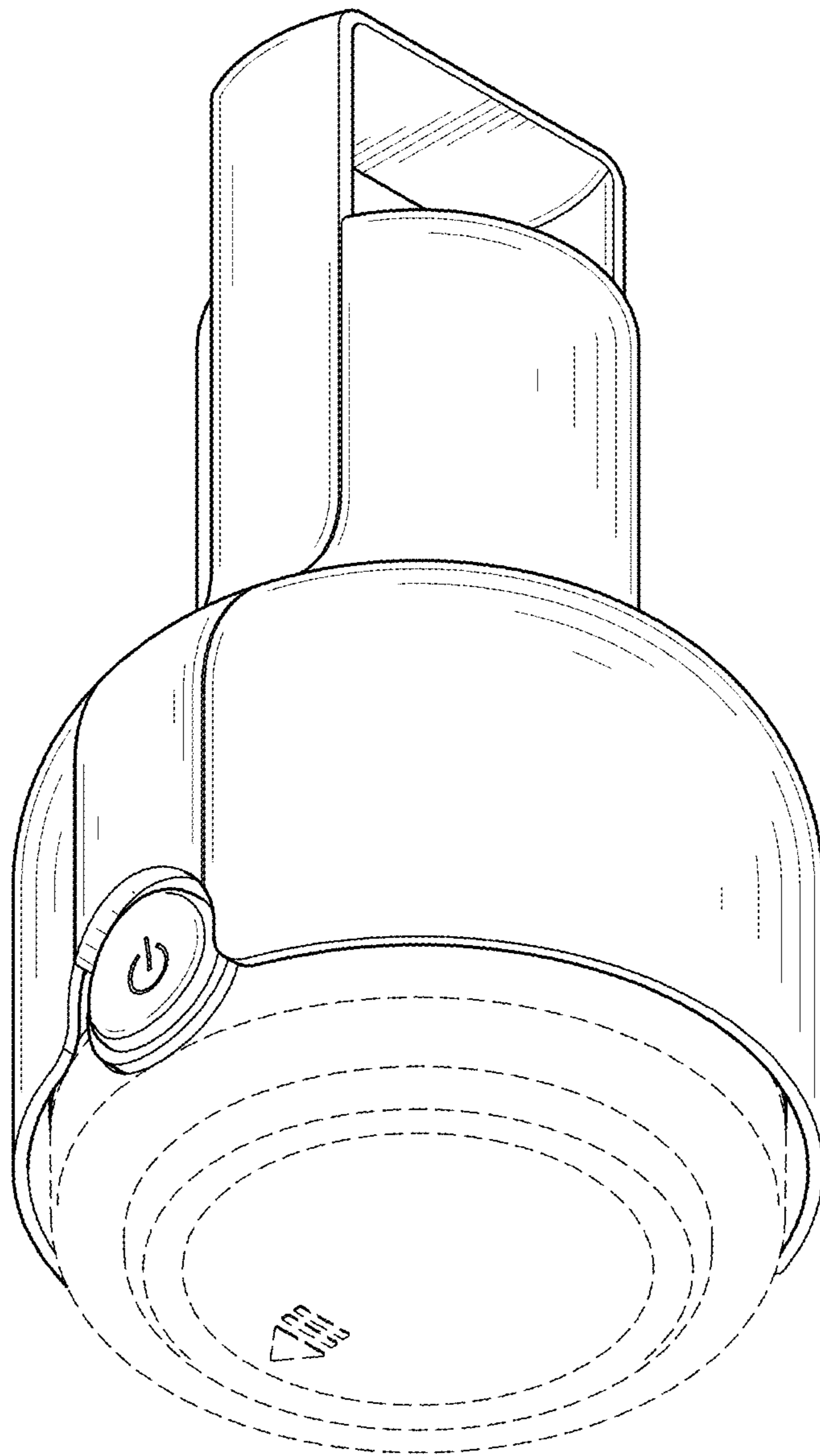

FIG. 11