



US00D791990S

(12) **United States Design Patent** (10) **Patent No.:** **US D791,990 S**
Williams (45) **Date of Patent:** **** Jul. 11, 2017**

(54) **INDIAN HEAD LENS**

(71) Applicant: **Marcus Williams**, Chattanooga, TN
(US)

(72) Inventor: **Marcus Williams**, Chattanooga, TN
(US)

(**) Term: **15 Years**

(21) Appl. No.: **29/557,280**

(22) Filed: **Mar. 8, 2016**

(51) **LOC (10) Cl.** **26-03**

(52) **U.S. Cl.**
USPC **D26/32**

(58) **Field of Classification Search**
USPC D26/24, 93, 94, 99, 32, 125, 126;
D11/131, 160, 128, 136
CPC .. F21S 6/00; F21S 6/002; F21V 21/02; F21W
2121/00; F21W 2131/30
See application file for complete search history.

(56) **References Cited**

U.S. PATENT DOCUMENTS

D86,934 S * 5/1932 Pucunus D26/32
D112,245 S * 11/1938 Donner D26/126
D147,925 S * 11/1947 Oates D11/136

D338,982 S * 8/1993 Terry D26/125
D392,059 S * 3/1998 Lee D26/32
7,073,618 B1 7/2006 Song et al.
D632,815 S * 2/2011 Madden D26/32
D662,651 S * 6/2012 Browder D26/125
D716,702 S 11/2014 Song et al.
D722,538 S 2/2015 Song et al.

* cited by examiner

Primary Examiner — Brian N Vinson
(74) *Attorney, Agent, or Firm* — Knox Patents; Thomas
A. Kulaga

(57) **CLAIM**

The ornamental design for an Indian head lens, as shown and described.

DESCRIPTION

FIG. 1 is a perspective view of an Indian head lens showing my new design.
FIG. 2 is a left side view thereof; the right side view being a mirror image of the left side.
FIG. 3 is a front view thereof.
FIG. 4 is a rear view thereof.
FIG. 5 is a top view thereof; and,
FIG. 6 is a bottom view thereof.
The broken line disclosure in the views represents portions of the lens which form no part of the claimed design.

1 Claim, 3 Drawing Sheets

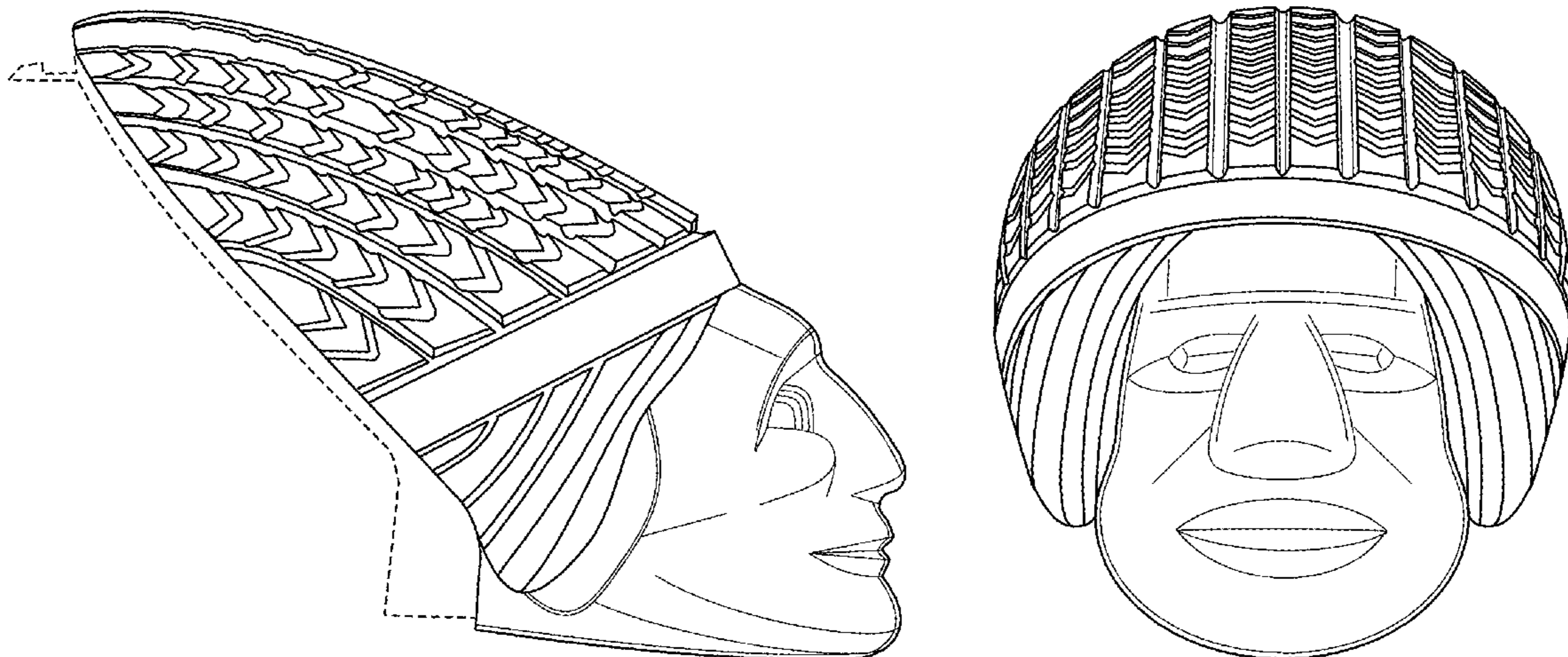

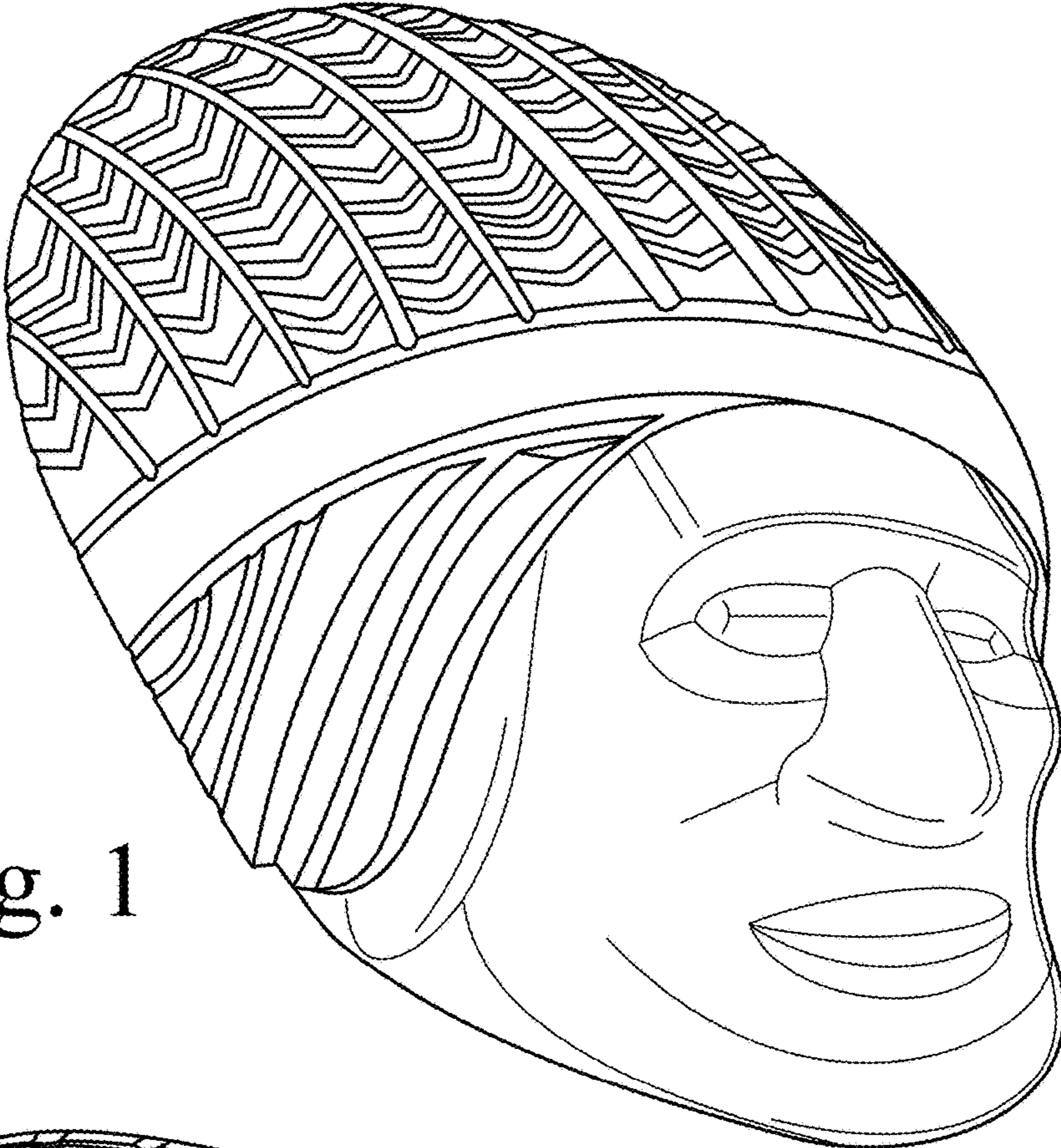

Fig. 1

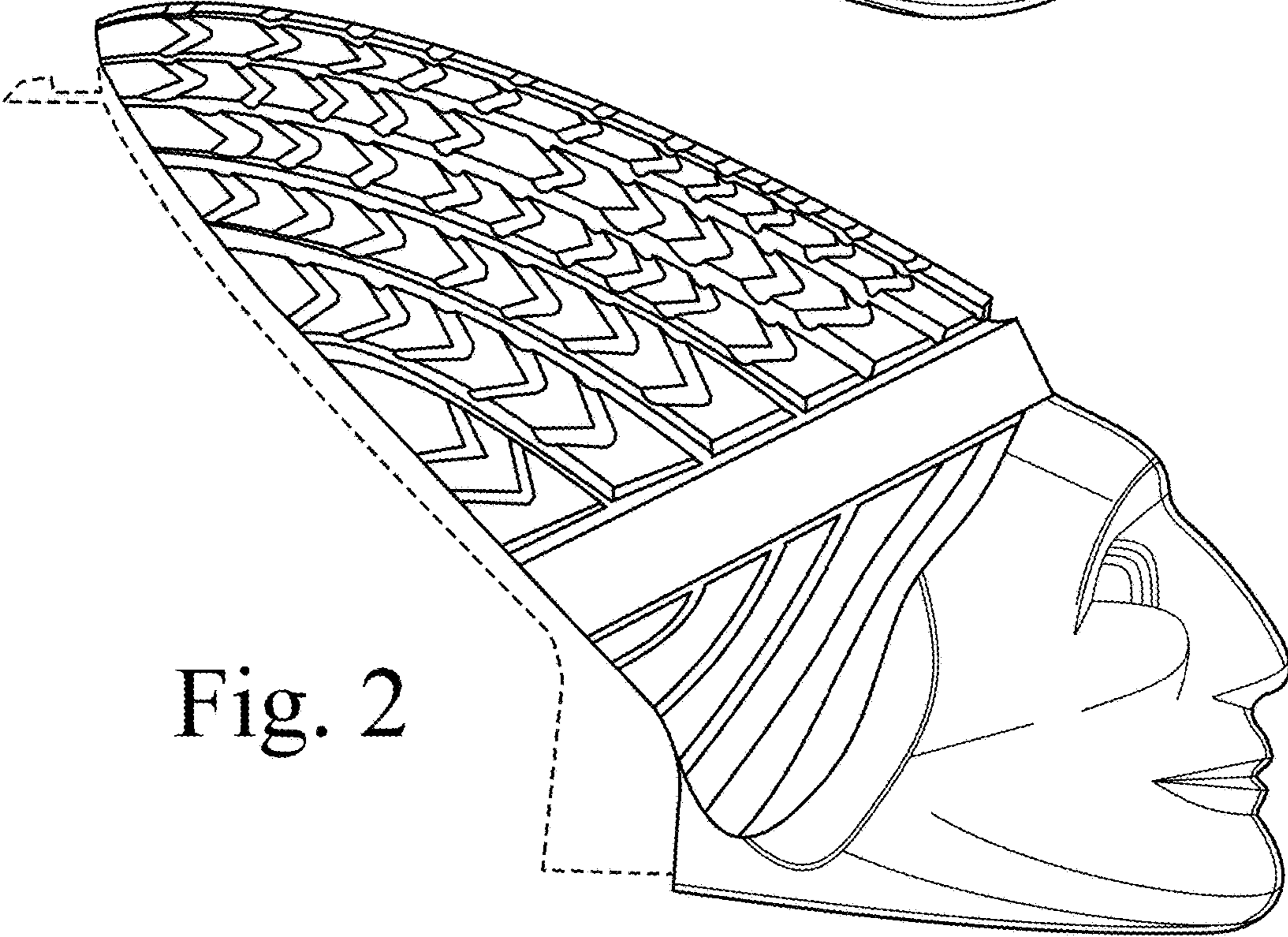

Fig. 2

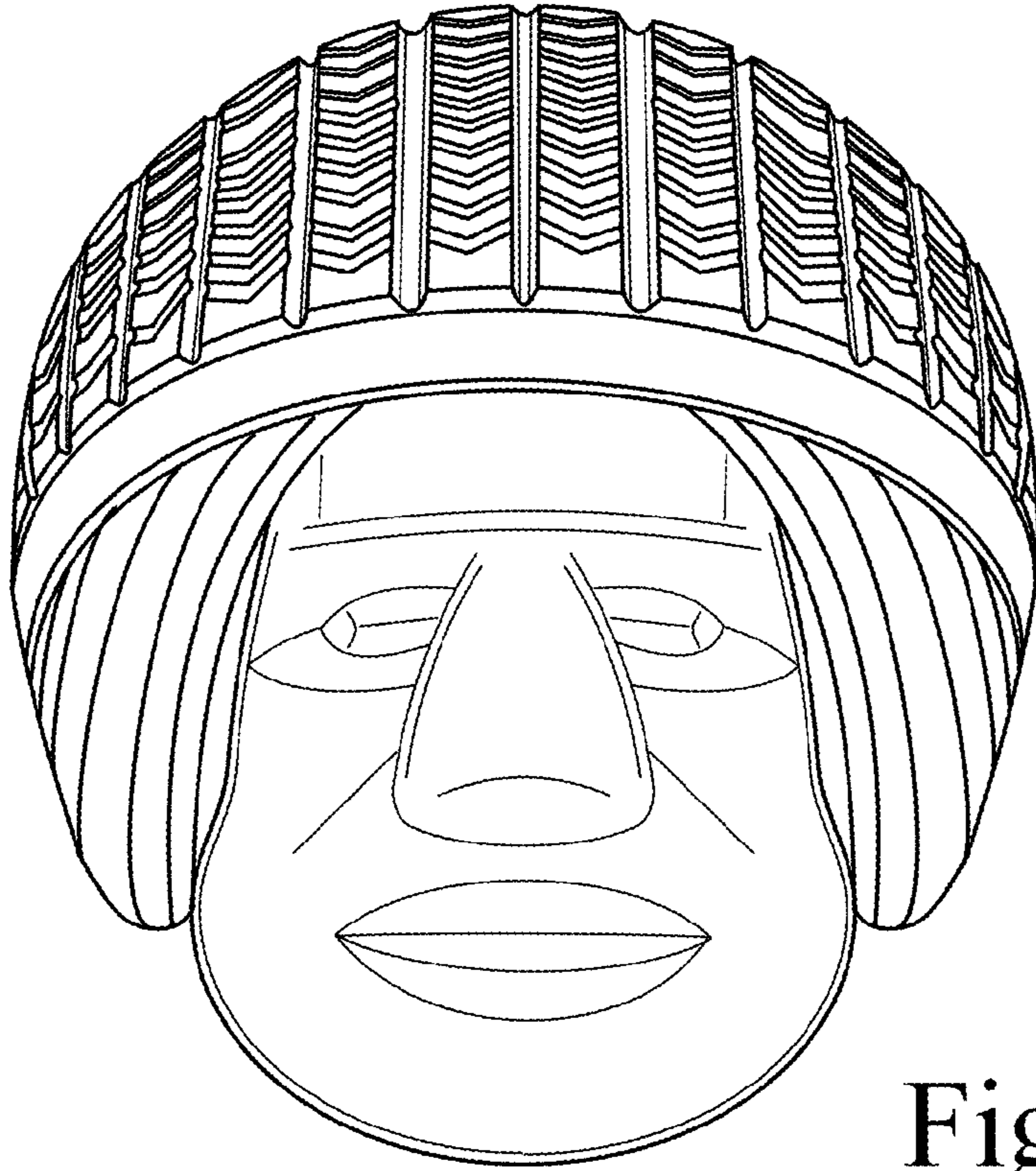

Fig. 3

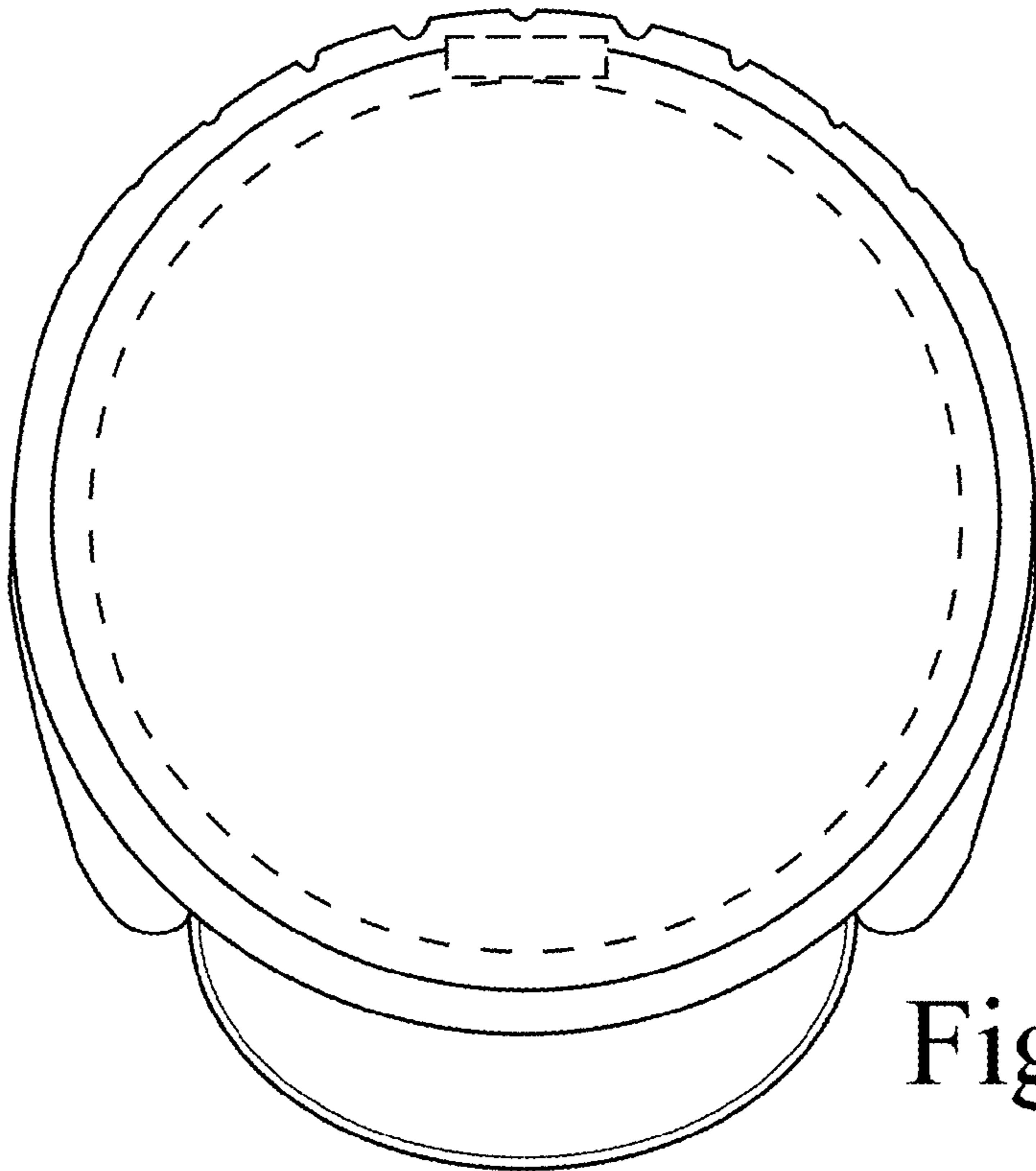

Fig. 4

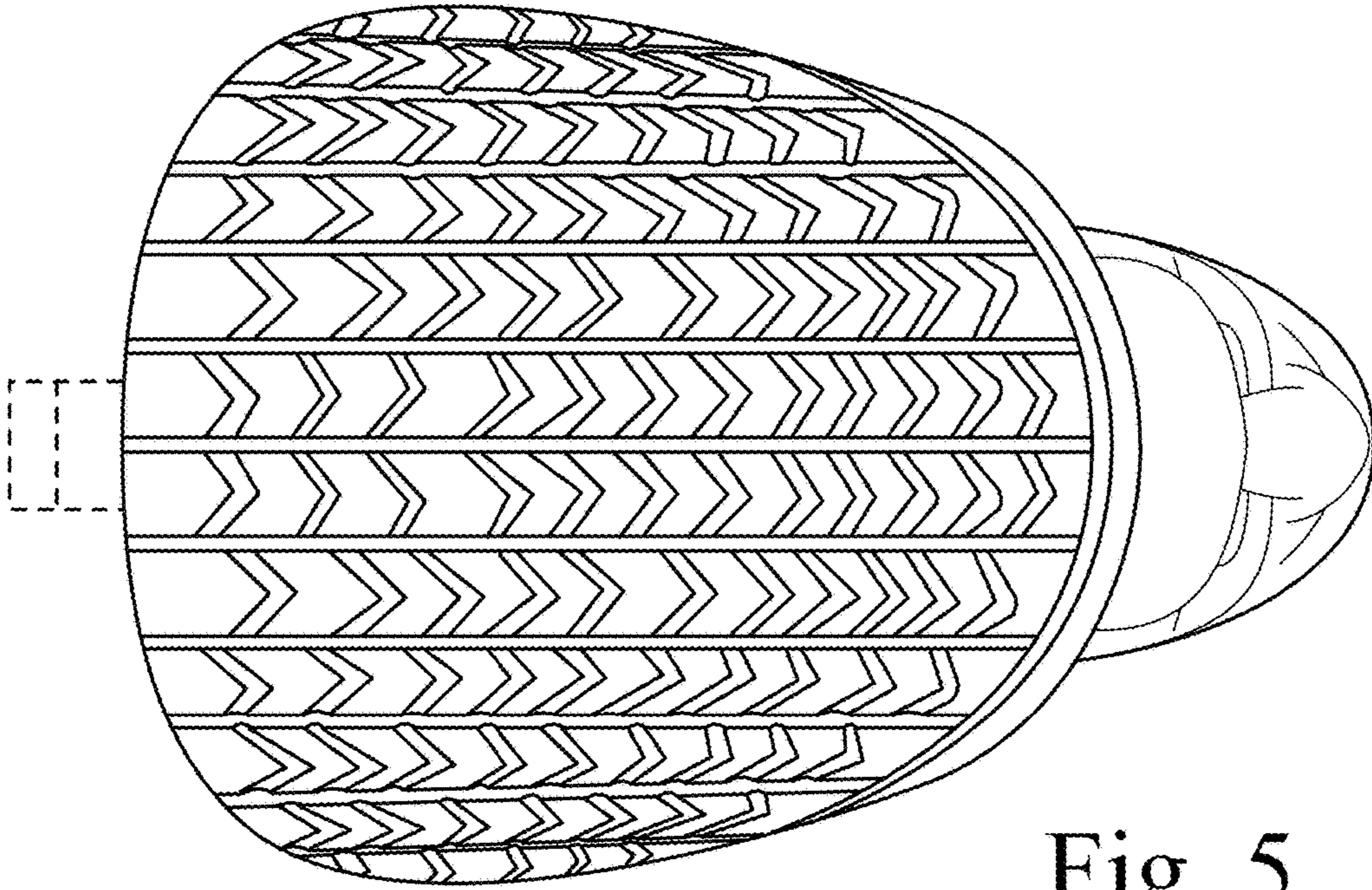

Fig. 5

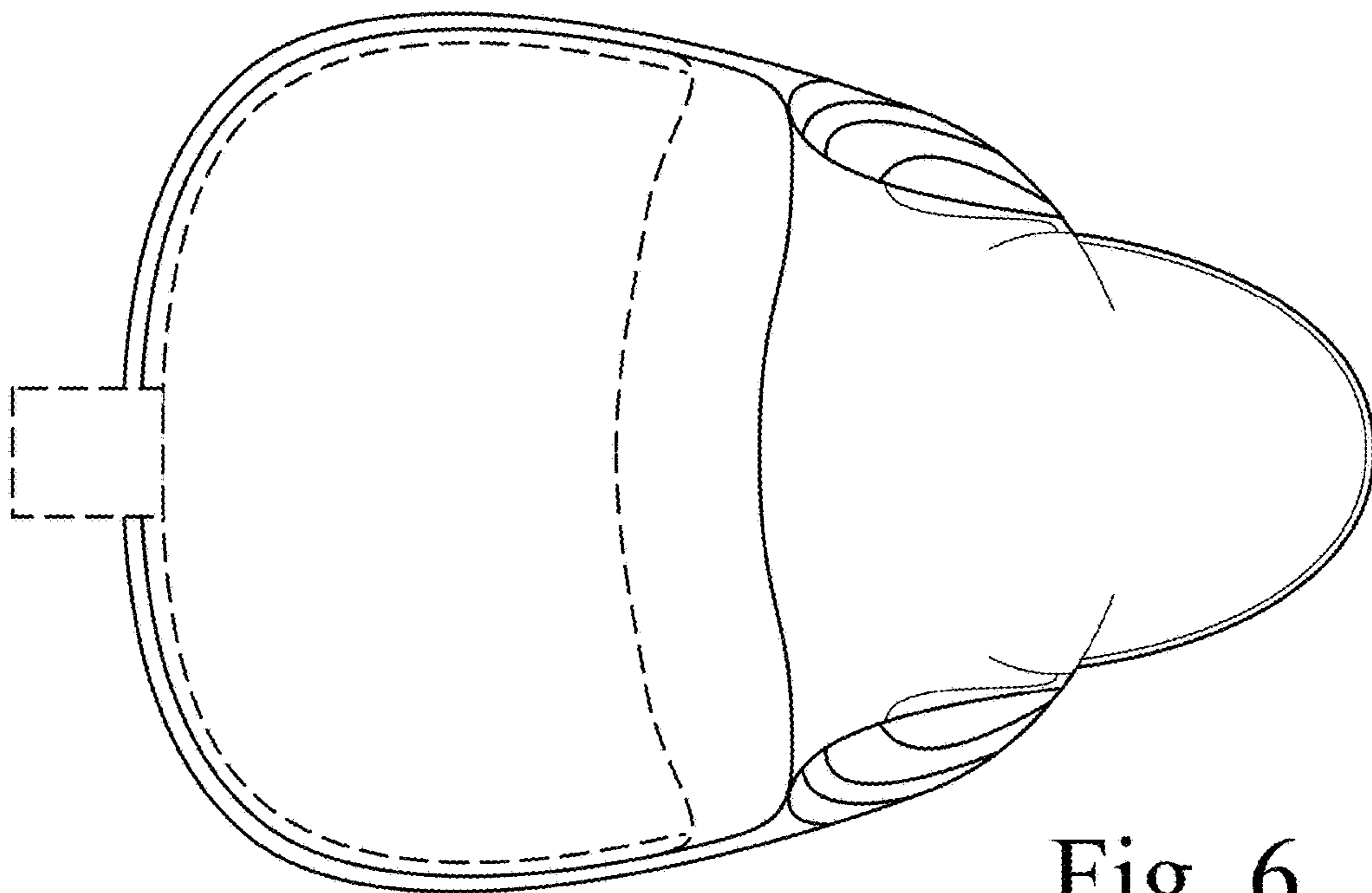

Fig. 6