

US00D791913S

(12) **United States Design Patent** (10) **Patent No.:** **US D791,913 S**
Andrew (45) **Date of Patent:** **** Jul. 11, 2017**

(54) **SHOWERHEAD** D701,587 S * 3/2014 Andrew D23/213
D701,940 S * 4/2014 Andrew D23/213
(71) Applicant: **DELTA FAUCET COMPANY,** D701,941 S * 4/2014 Andrew D23/213
Indianapolis, IN (US)

* cited by examiner

(72) Inventor: **Mercedita Andrew,** Indianapolis, IN (US)

Primary Examiner — Robin V Webster

(74) *Attorney, Agent, or Firm* — Edgar A. Zarins; Nirav D. Parikh

(73) Assignee: **DELTA FAUCET COMPANY,** Indianapolis, IN (US)

(**) Term: **15 Years**

(57) **CLAIM**

The ornamental design for a showerhead, as shown and described.

(21) Appl. No.: **29/554,928**

(22) Filed: **Feb. 17, 2016**

DESCRIPTION

(51) **LOC (10) Cl.** **23-01**

(52) **U.S. Cl.**
USPC **D23/213**

(58) **Field of Classification Search**
USPC D23/213, 223, 226, 229, 230; 239/282,
239/283, 526, 289

CPC B05B 1/00; B05B 1/18; B05B 9/01
See application file for complete search history.

FIG. 1 is a perspective view of a showerhead showing my new design;
FIG. 2 is a front elevational view thereof;
FIG. 3 is a left side view thereof, the opposite side being a mirror image of the side shown;
FIG. 4 is a cross-sectional view thereof taken along line 4-4 in FIG. 1;
FIG. 5 is a top end view thereof;
FIG. 6 is a bottom end view thereof; and,
FIG. 7 is a rear view thereof.

The broken line showing of the front water nozzles and rear attachment is included for the purpose of illustrating and forms no part of the claimed design.

(56) **References Cited**

U.S. PATENT DOCUMENTS

D578,181 S * 10/2008 Pan D23/213
D626,194 S * 10/2010 Kakihana D23/213
D701,289 S * 3/2014 Andrew D23/213
D701,586 S * 3/2014 Andrew D23/213

1 Claim, 5 Drawing Sheets

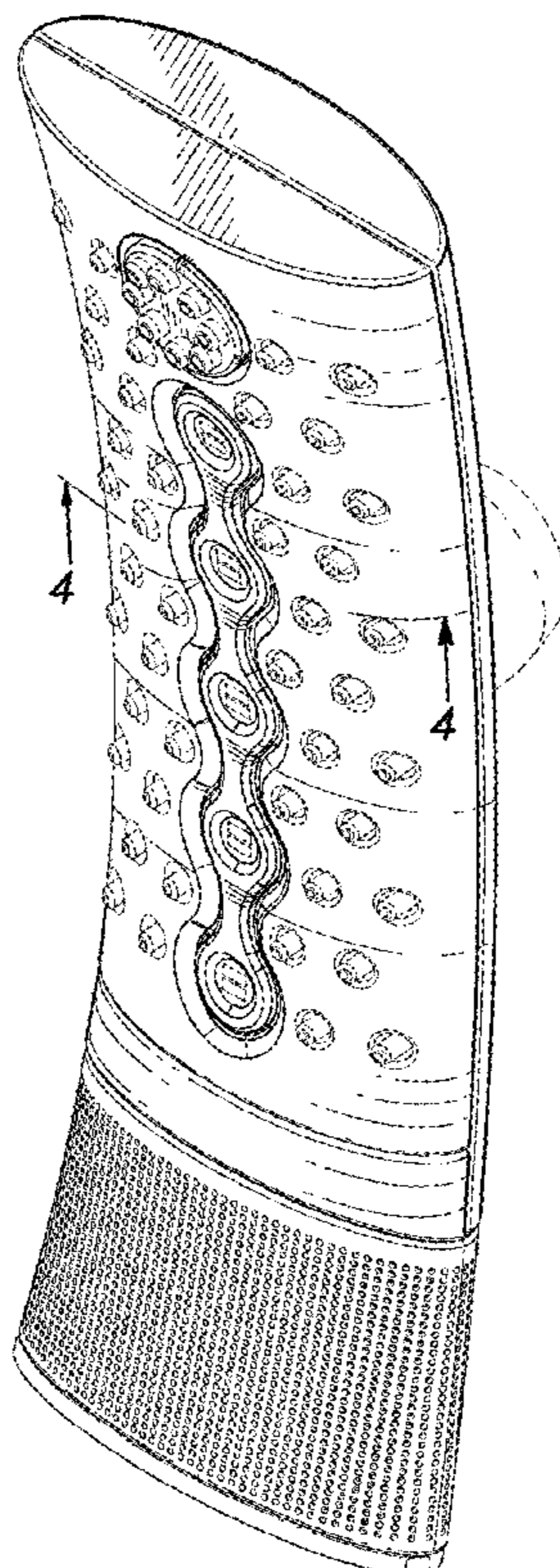

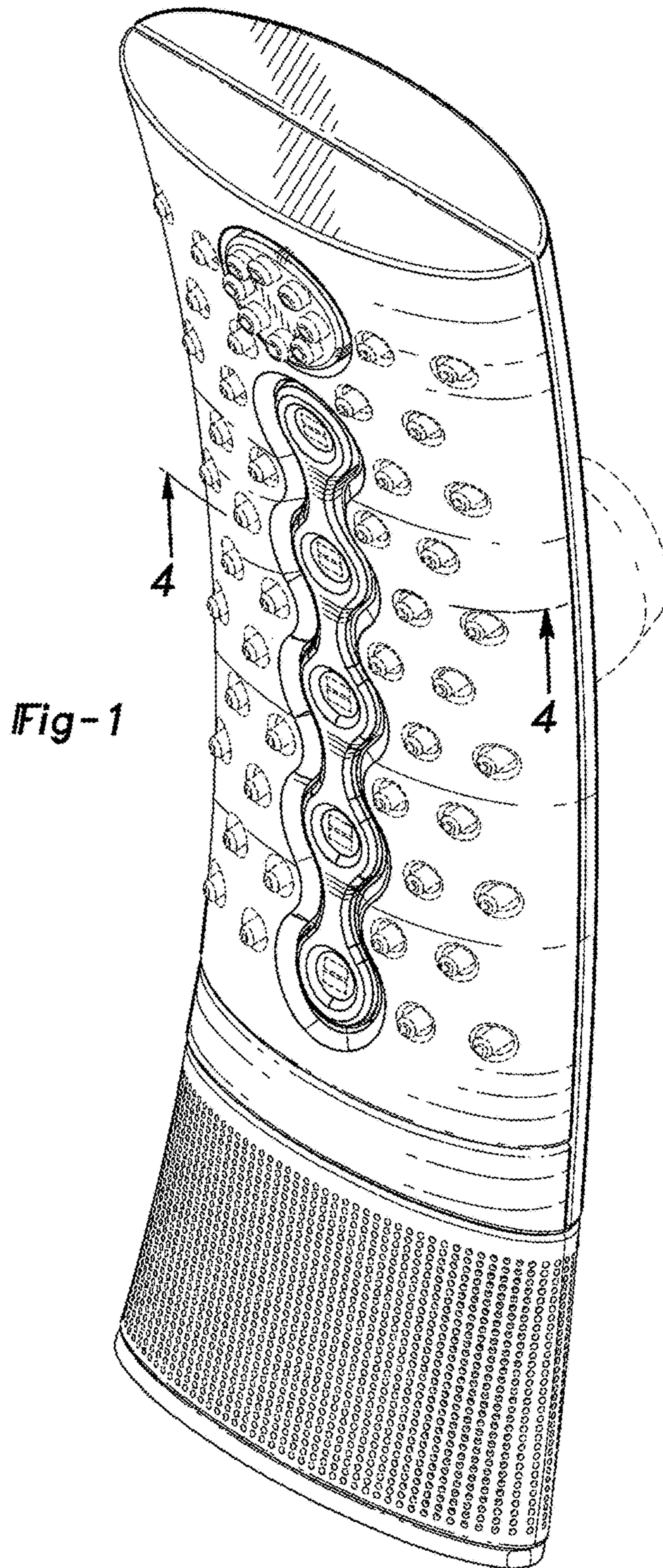

Fig-2

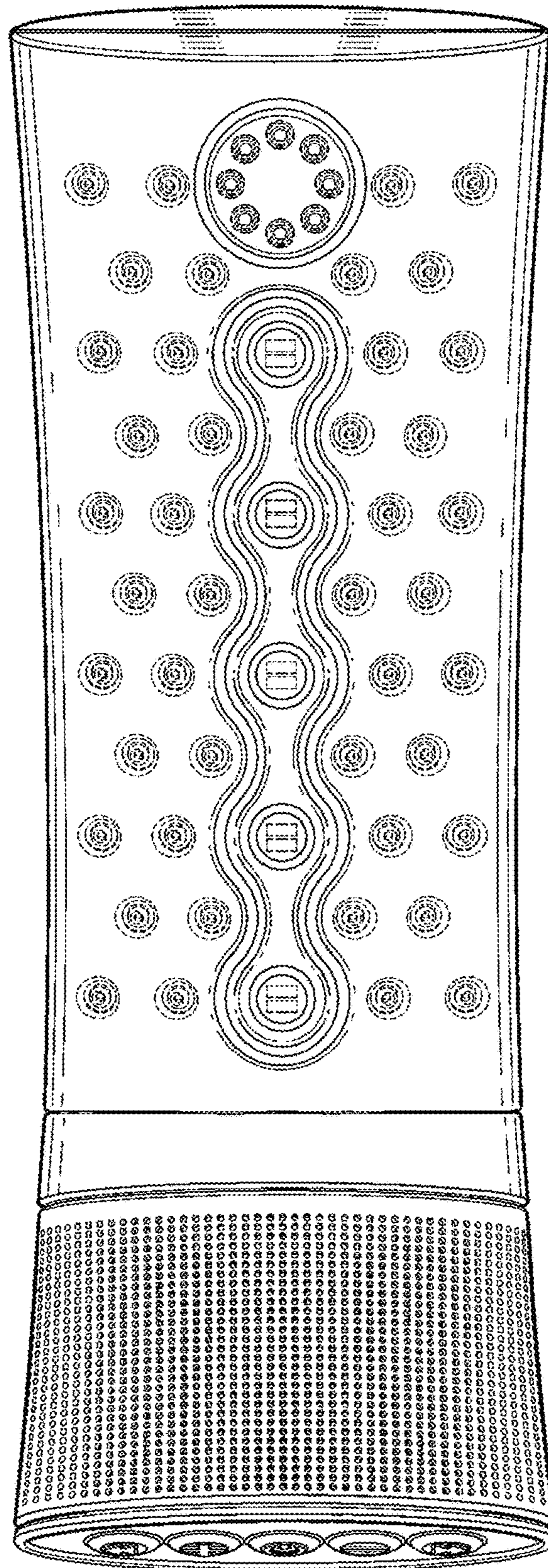
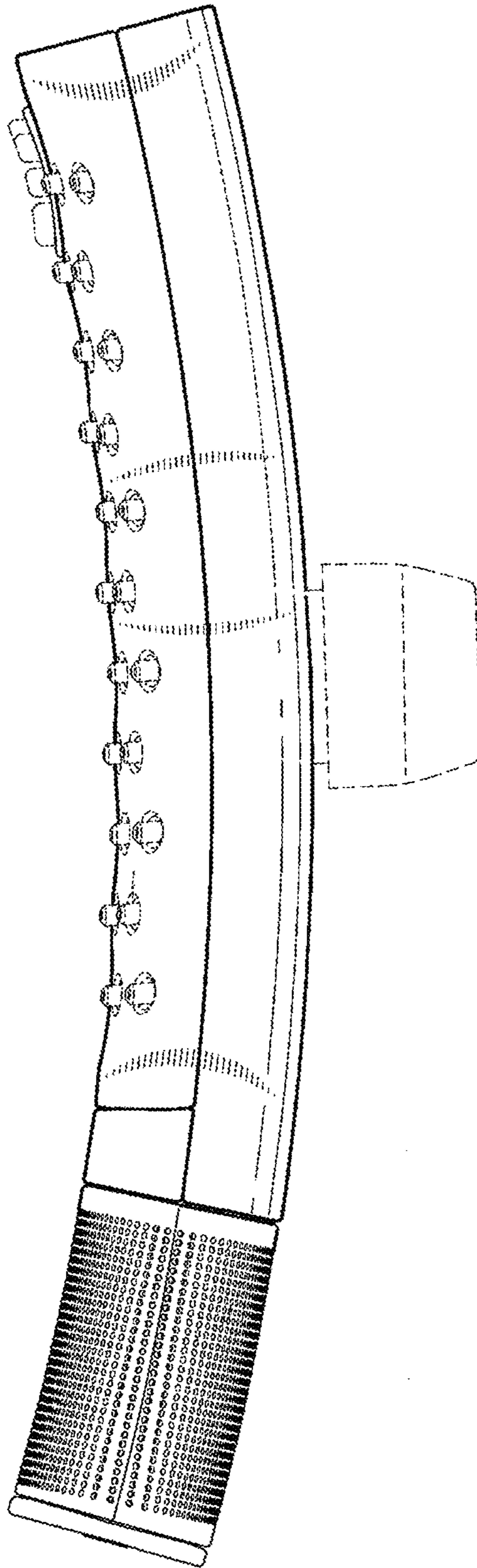

Fig-3



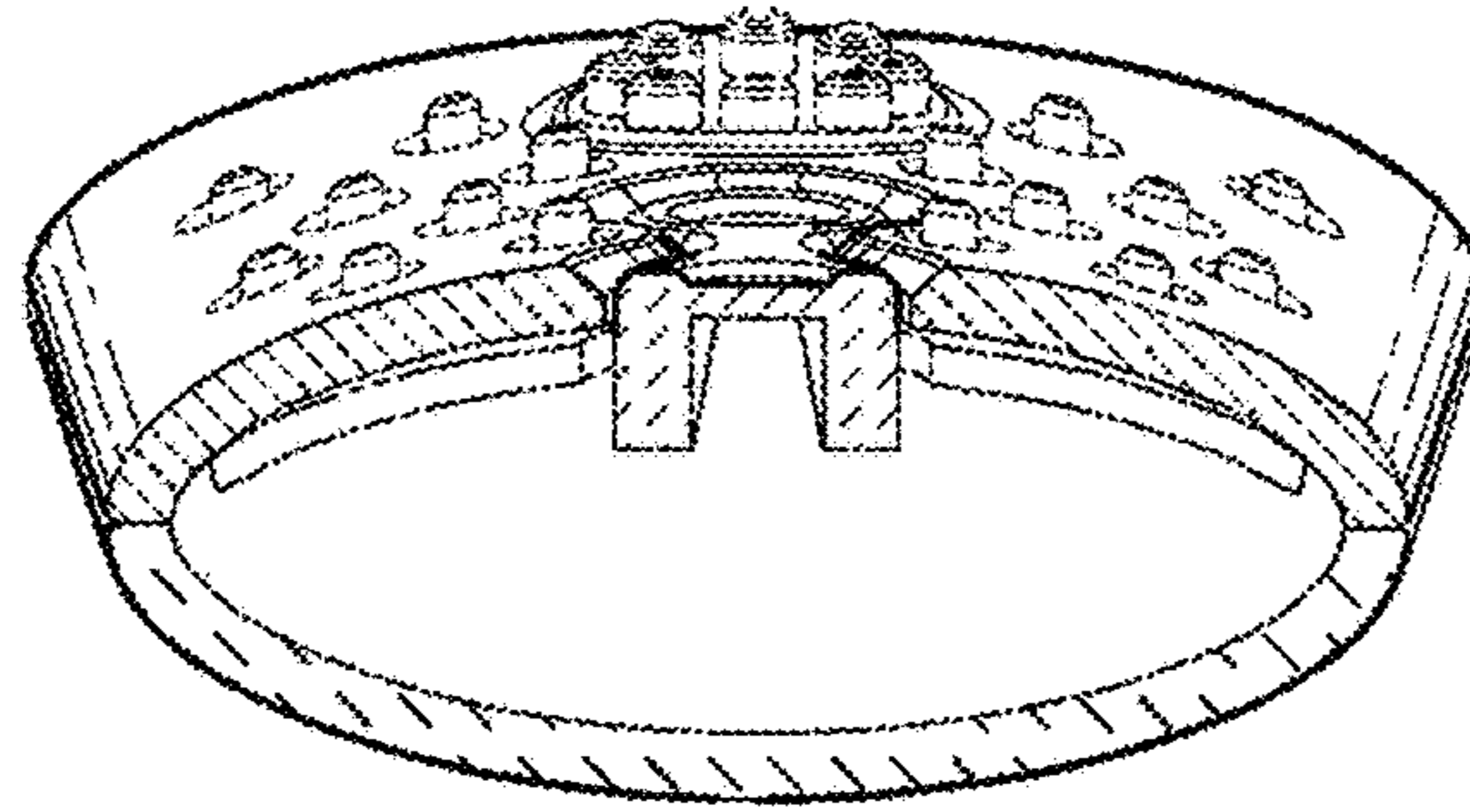

Fig-4

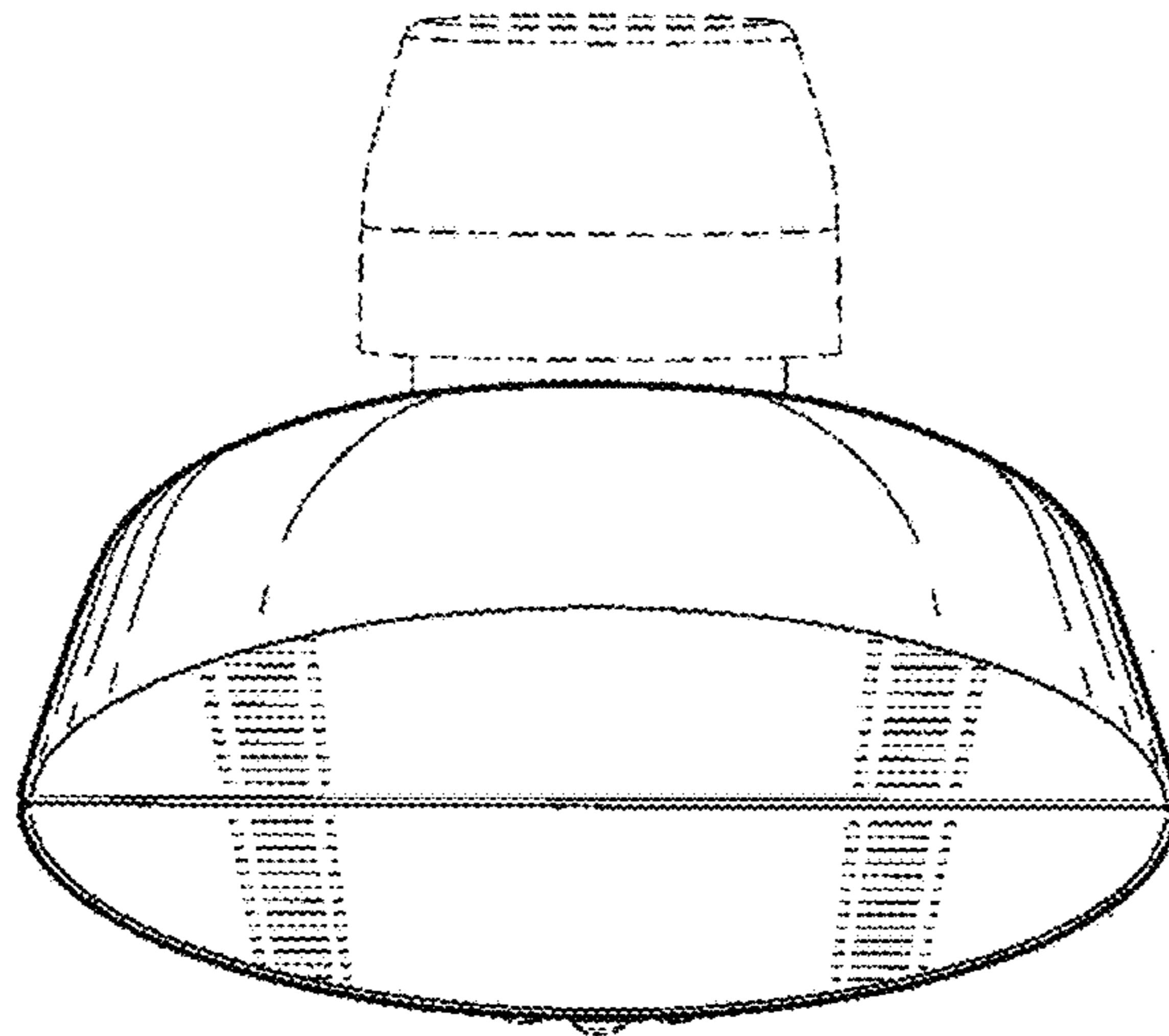

Fig-5

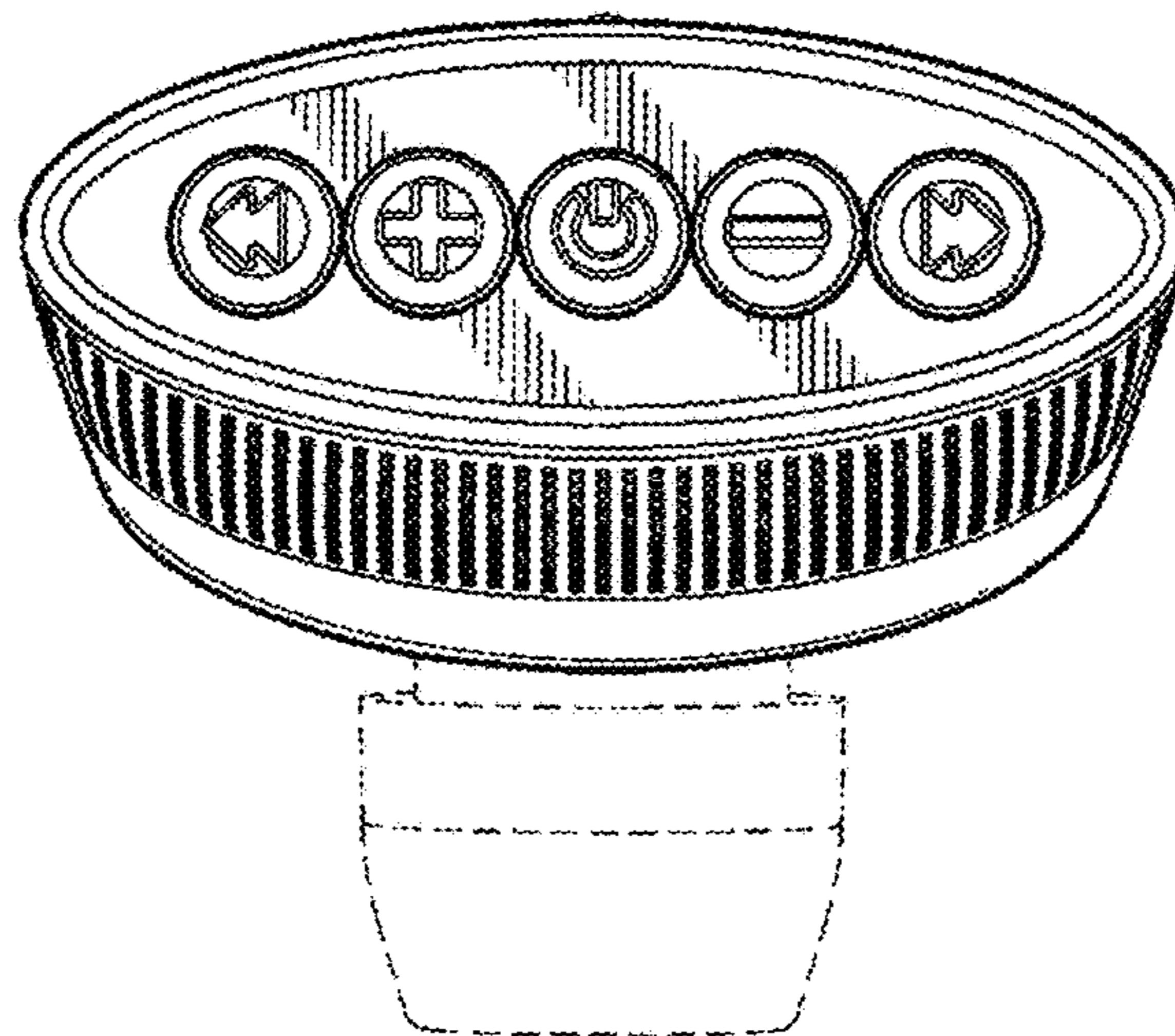

Fig-6

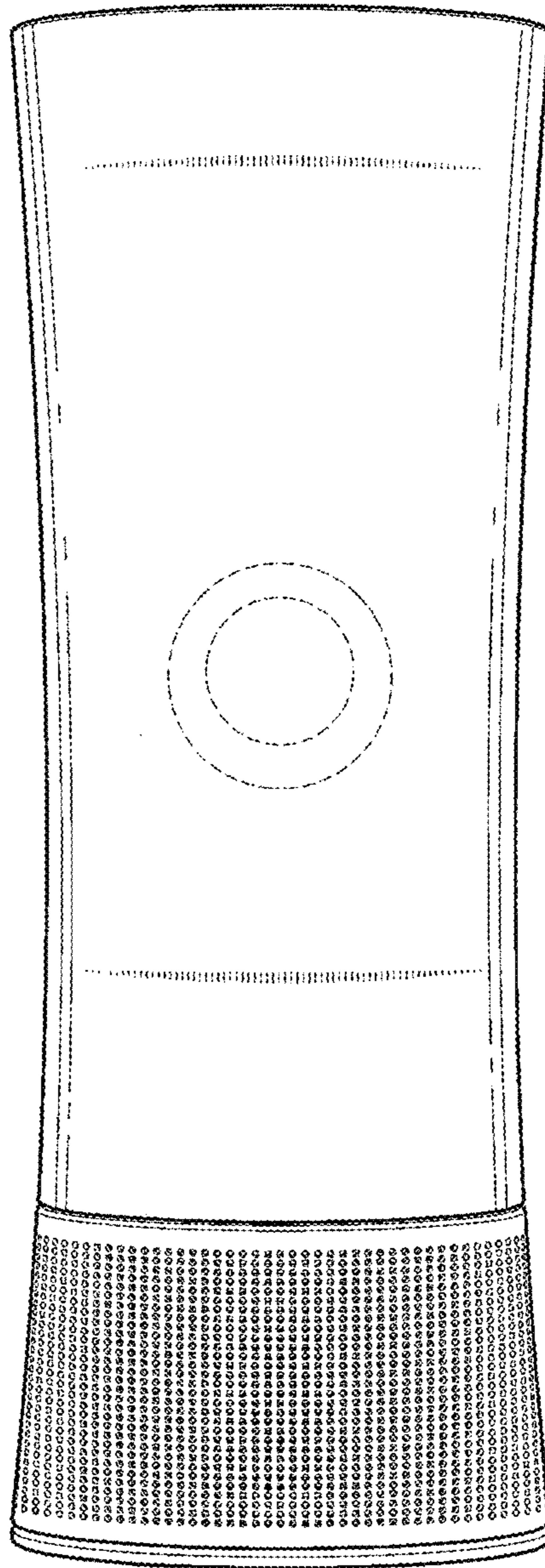

Fig-7