

US00D791755S

(12) **United States Design Patent** (10) **Patent No.:** **US D791,755 S**
Kim (45) **Date of Patent:** **** Jul. 11, 2017**

(54) **CASE FOR ELECTRONIC DEVICE**

- (71) Applicant: **Dae-Young Kim**, Seoul (KR)
- (72) Inventor: **Dae-Young Kim**, Seoul (KR)
- (73) Assignee: **SPIGEN KOREA CO., LTD.**,
Geumcheon-Gu, Seoul (KR)

(**) Term: **14 Years**

(21) Appl. No.: **29/506,117**

(22) Filed: **Oct. 13, 2014**

(51) **LOC (10) Cl.** **14-01**

(52) **U.S. Cl.**
USPC **D14/250**

(58) **Field of Classification Search**
 USPC D14/250–253, 440, 203.3–203.7, 217,
 D14/496, 248, 238.1, 240, 447, 230, 247,
 D14/341, 345, 346, 439; D3/201, 218,
 D3/269, 301, 273, 303; D13/103,
 D13/107–108; 220/4.02; 248/309.1;
 361/679.56; 379/426, 433.11, 455;
 455/575.1, 575.8; 190/100; 206/305,
 206/320
 CPC . A45C 2011/002; A45C 11/00; A45C 13/002;
 A45C 2011/003; H04M 1/0283; H04M
 1/0202; H04M 1/185; H04B 1/3888
 See application file for complete search history.

(56) **References Cited**

U.S. PATENT DOCUMENTS

- 8,430,240 B2 * 4/2013 Kim A45C 11/00
206/320
- 8,695,798 B2 * 4/2014 Simmer G06F 1/1626
206/320
- D724,572 S * 3/2015 Wildner D14/250
- D727,304 S * 4/2015 Lee D14/248
- D729,781 S * 5/2015 Lee D14/248
- D733,693 S * 7/2015 Wang D14/248
- D736,205 S * 8/2015 Park D14/138 R
- D738,871 S * 9/2015 Ryu D14/138 C

(Continued)

OTHER PUBLICATIONS

Fone Stuff, Samsung Galaxy Note 4 Tough Case, “https://www.amazon.co.uk/Samsung-Galaxy-Note-Tough-Fone-Stuff%C2%AE/dp/B011INCOK6/ref=sr_1_3?ie=UTF8&qid=1470418202&sr=8-3&keywords=fone+stuff+tough+case+note”, available online Jul. 13, 2015 (retrieved online Aug. 5, 2016).*

(Continued)

Primary Examiner — Sandra Snapp

Assistant Examiner — Holly E Thurman

(74) *Attorney, Agent, or Firm* — East West Law Group;
Heedong Chae

(57) **CLAIM**

The ornamental design for a case for electronic device, as shown and described.

DESCRIPTION

FIG. 1 is a front perspective view of a case for electronic device, comprised of inner shell and outer frame, showing my new design;
 FIG. 2 is a rear perspective view thereof;
 FIG. 3 is a front elevational view thereof;
 FIG. 4 is a rear elevational view thereof;
 FIG. 5 is a left side elevational view thereof;
 FIG. 6 is a right side elevational view thereof;
 FIG. 7 is a top plan view thereof;
 FIG. 8 is a bottom plan view thereof;
 FIG. 9 is an exploded front perspective view thereof showing the inner shell and outer frame of the case for electronic device separated for clarity of disclosure;
 FIG. 10 is an exploded rear perspective view thereof;
 FIG. 11 is a front perspective view showing only the inner shell for clarity of disclosure;
 FIG. 12 is a rear perspective view thereof;
 FIG. 13 is a front perspective view showing only the outer frame for clarity of disclosure; and,
 FIG. 14 is a rear perspective view thereof.

1 Claim, 14 Drawing Sheets

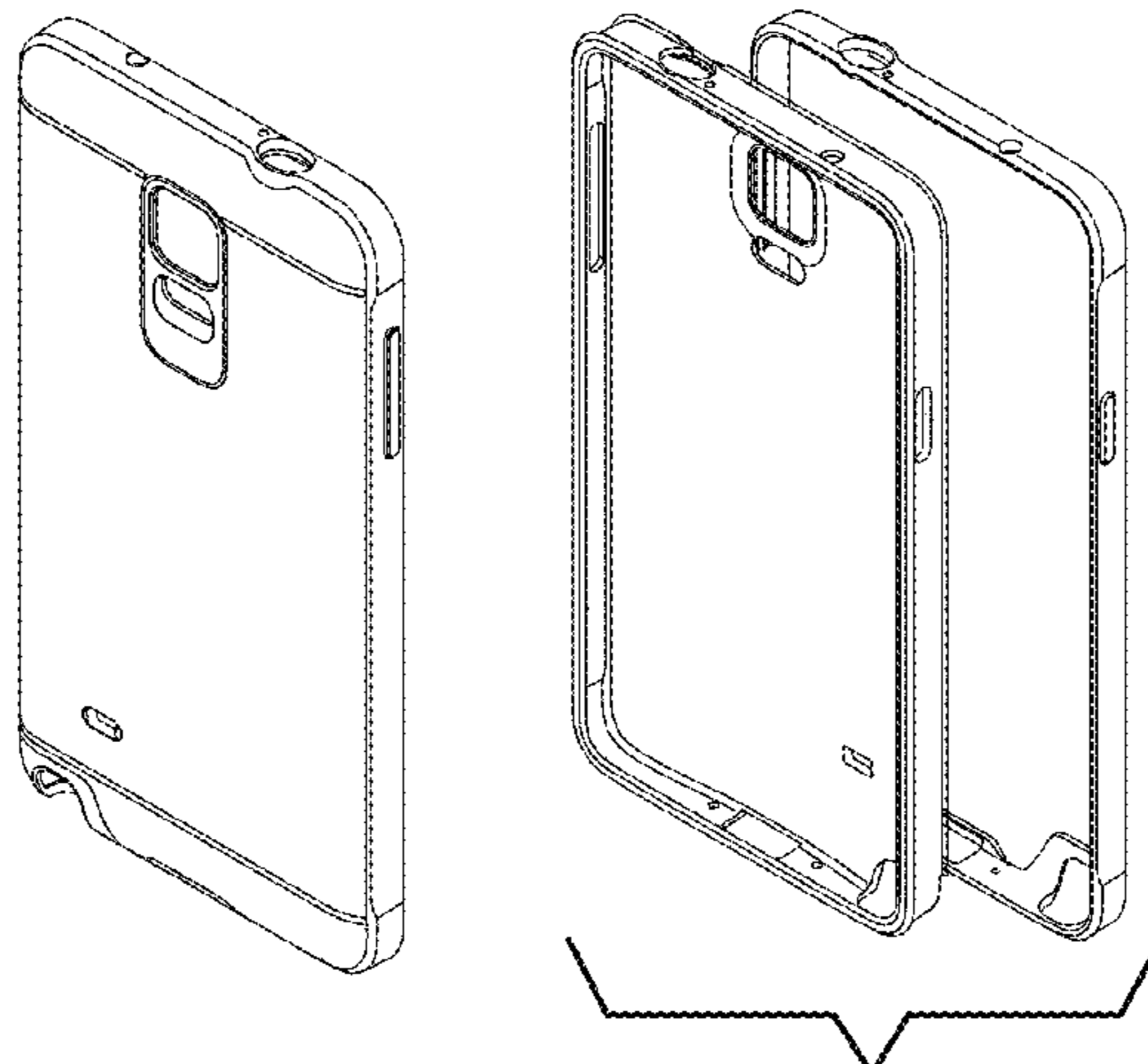

(56)

References Cited

U.S. PATENT DOCUMENTS

D739,391 S * 9/2015 Chen D14/248
 D739,393 S * 9/2015 Chang D14/248
 D741,279 S * 10/2015 Tai D14/138 G
 D746,275 S * 12/2015 Mohammad D14/250
 D761,239 S * 7/2016 Kim D14/250
 2014/0110276 A1 * 4/2014 Stiehl B29C 45/1676
 206/37

OTHER PUBLICATIONS

Spigen, Tough Armor Case for Galaxy S5, “https://www.amazon.co.uk/Spigen-Tough-Armor-Cover-Galaxy/dp/B00I3UWDV8/ref=sr_1_2?ie=UTF8&qid=1470423194&sr=8-2&keywords=spigen+galaxy+s5”, available online Mar. 24, 2013 (retrieved online Aug. 5, 2016).*

Tudia, Ultra Slim Lite TPU Bumper Protective Case for Samsung Galaxy S5, “https://www.amazon.co.uk/TUDIA-Protective-Compatible-Wireless-Charging/dp/B00N2EY1L0/ref=sr_1_24?ie=UTF8&qid=1470422906&sr=8-24&keywords=spigen+galaxy+s5”, available online Sep. 16, 2014 (retrieved online Aug. 5, 2016).*

Spigen, Galaxy Note 4 Case Neo Hybrid, “https://www.amazon.co.uk/Spigen-Galaxy-Hybrid-Metal-SGP11119-Slate/dp/B00MAWRB44/ref=pd_sim_sbs_23_3?ie=UTF8&psc=1&refRID=J92BWH04KKTGMZ1YWBC”, available online Aug. 13, 2014 (retrieved Sep. 7, 2016).*

* cited by examiner

FIG. 1

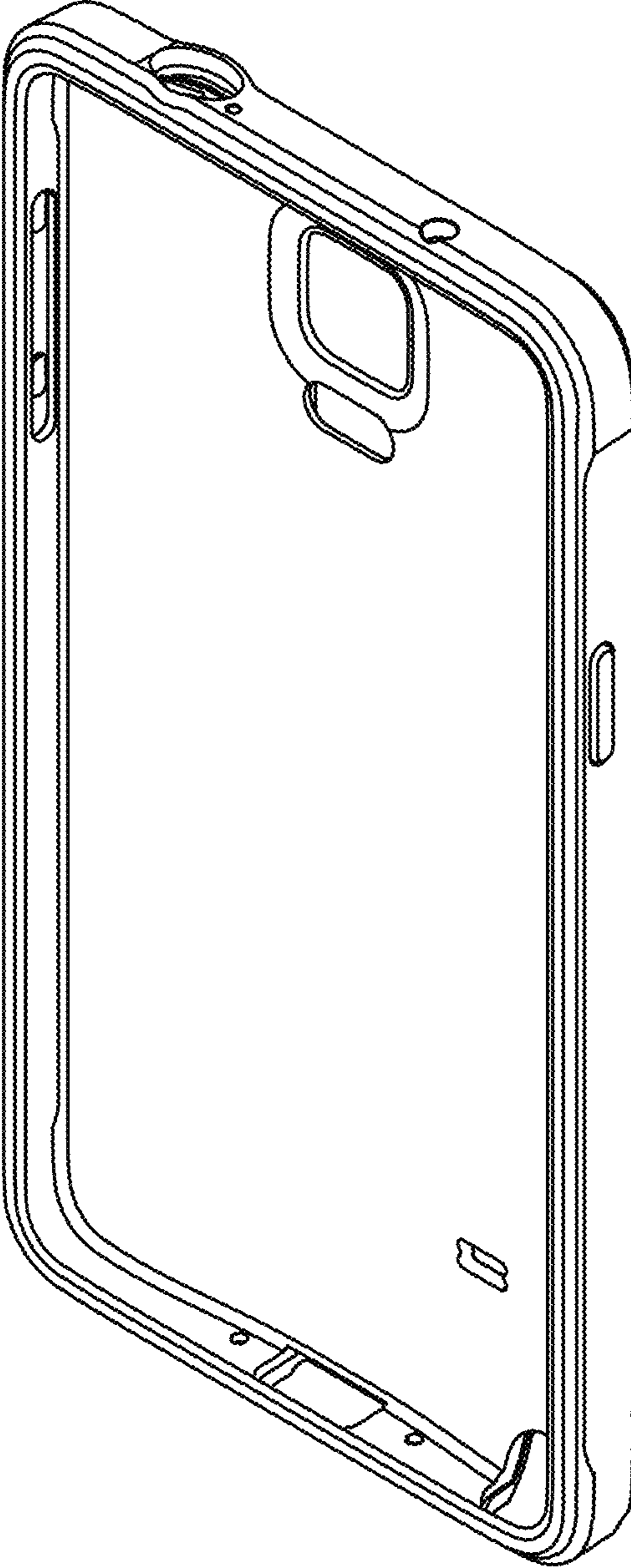

FIG. 2

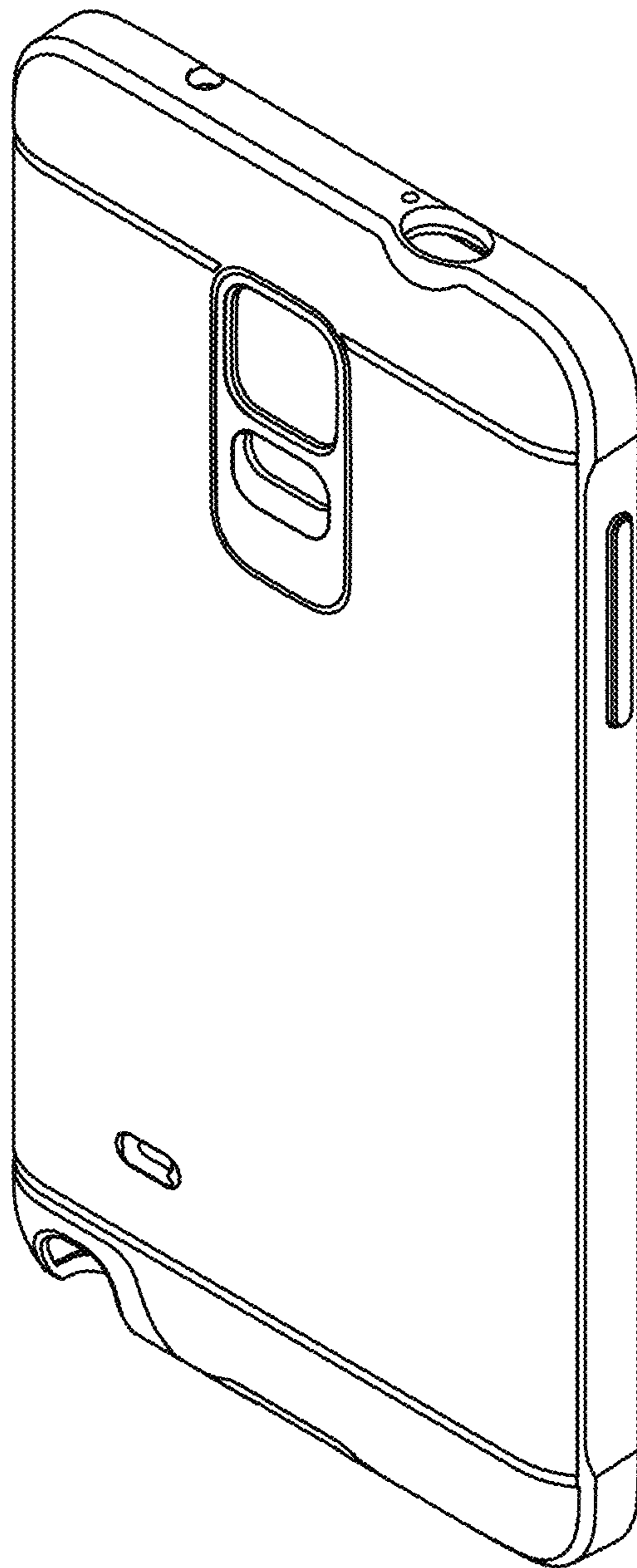

FIG. 3

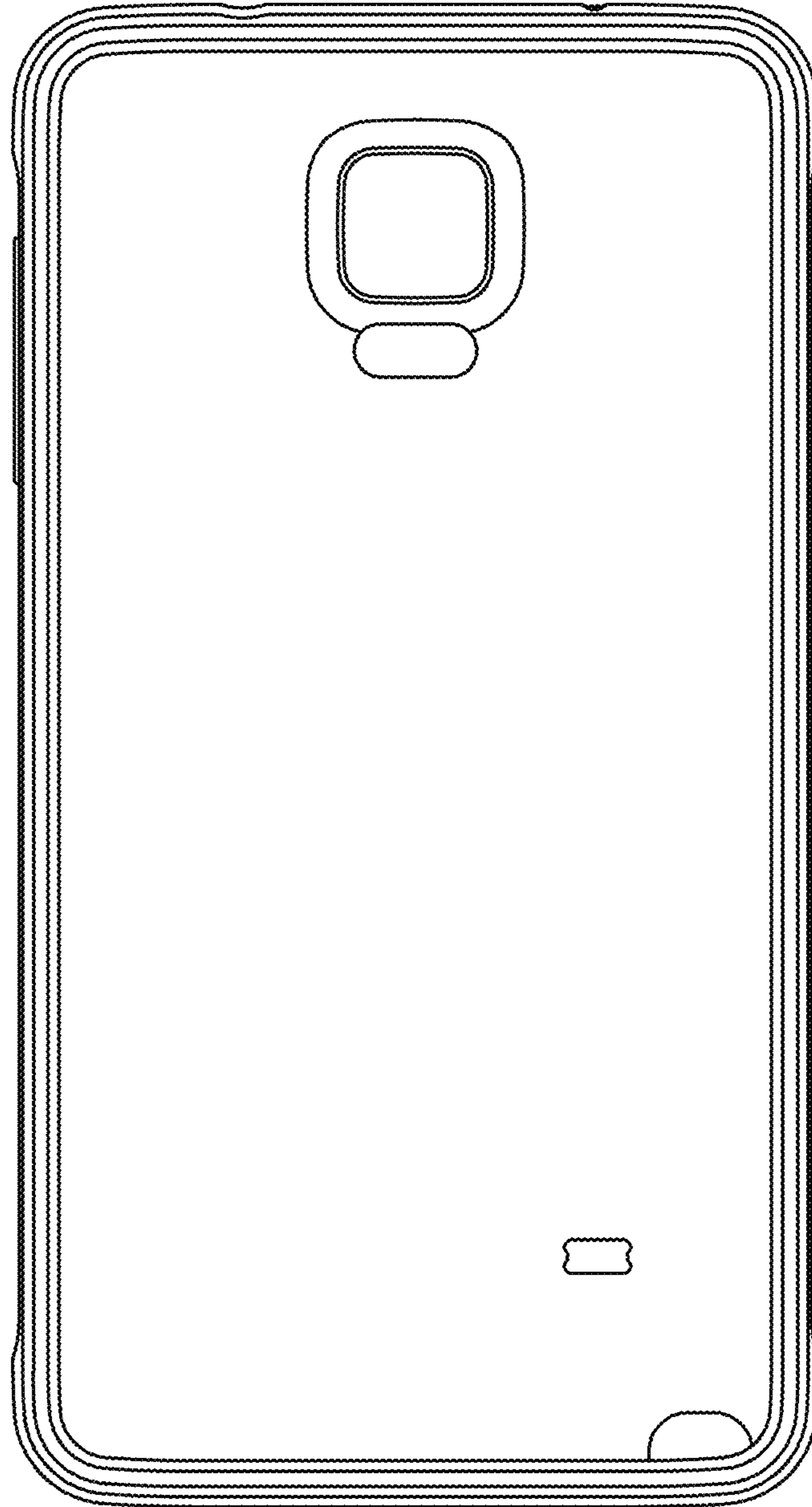

FIG. 4

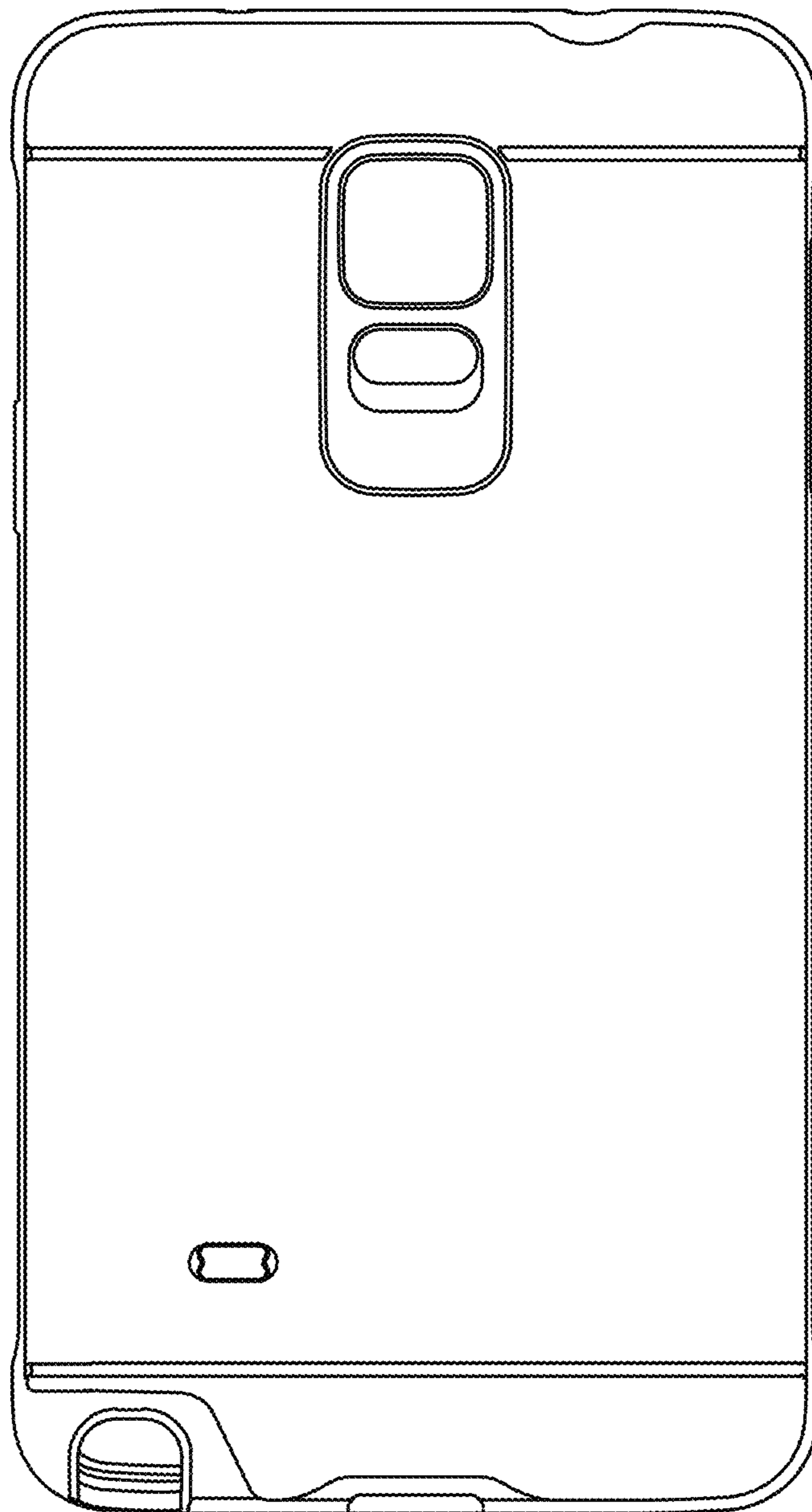

FIG. 5

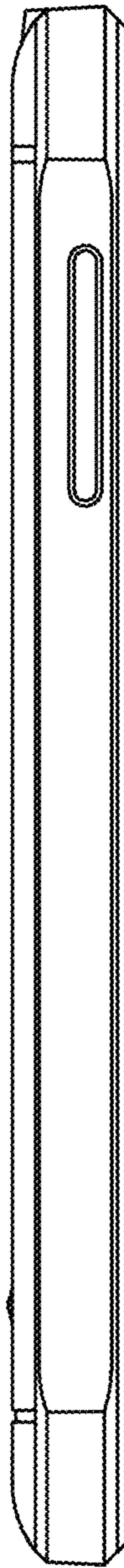

FIG. 6

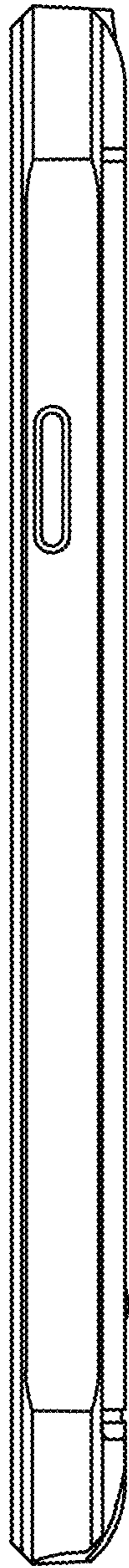

FIG. 7

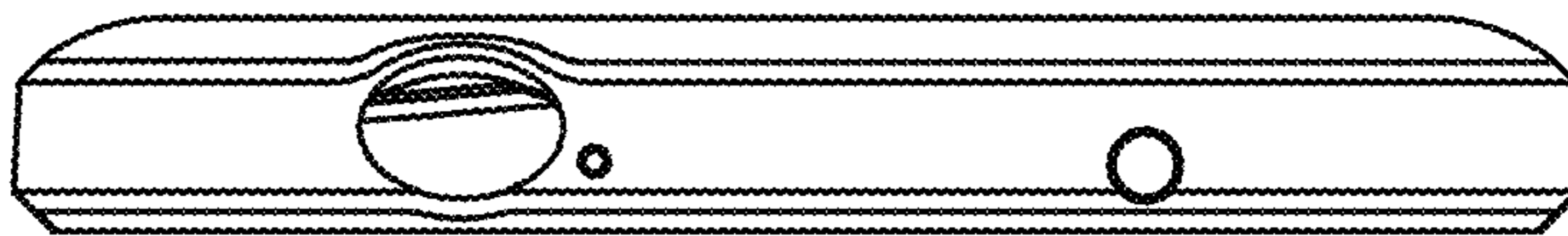

FIG. 8

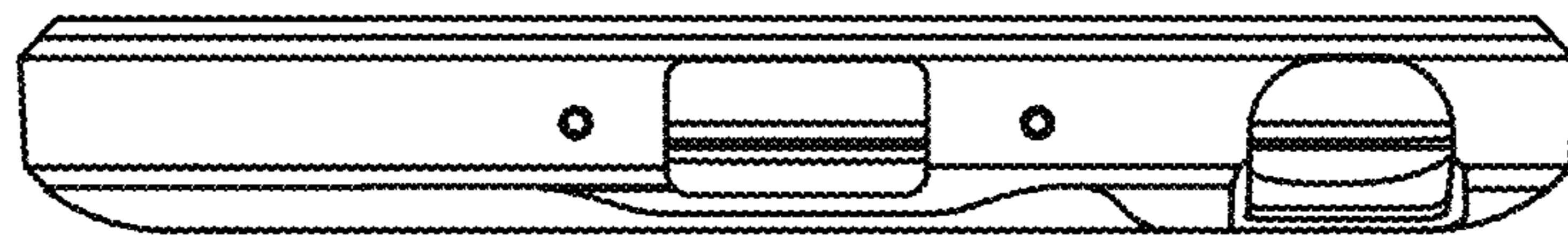

FIG. 9

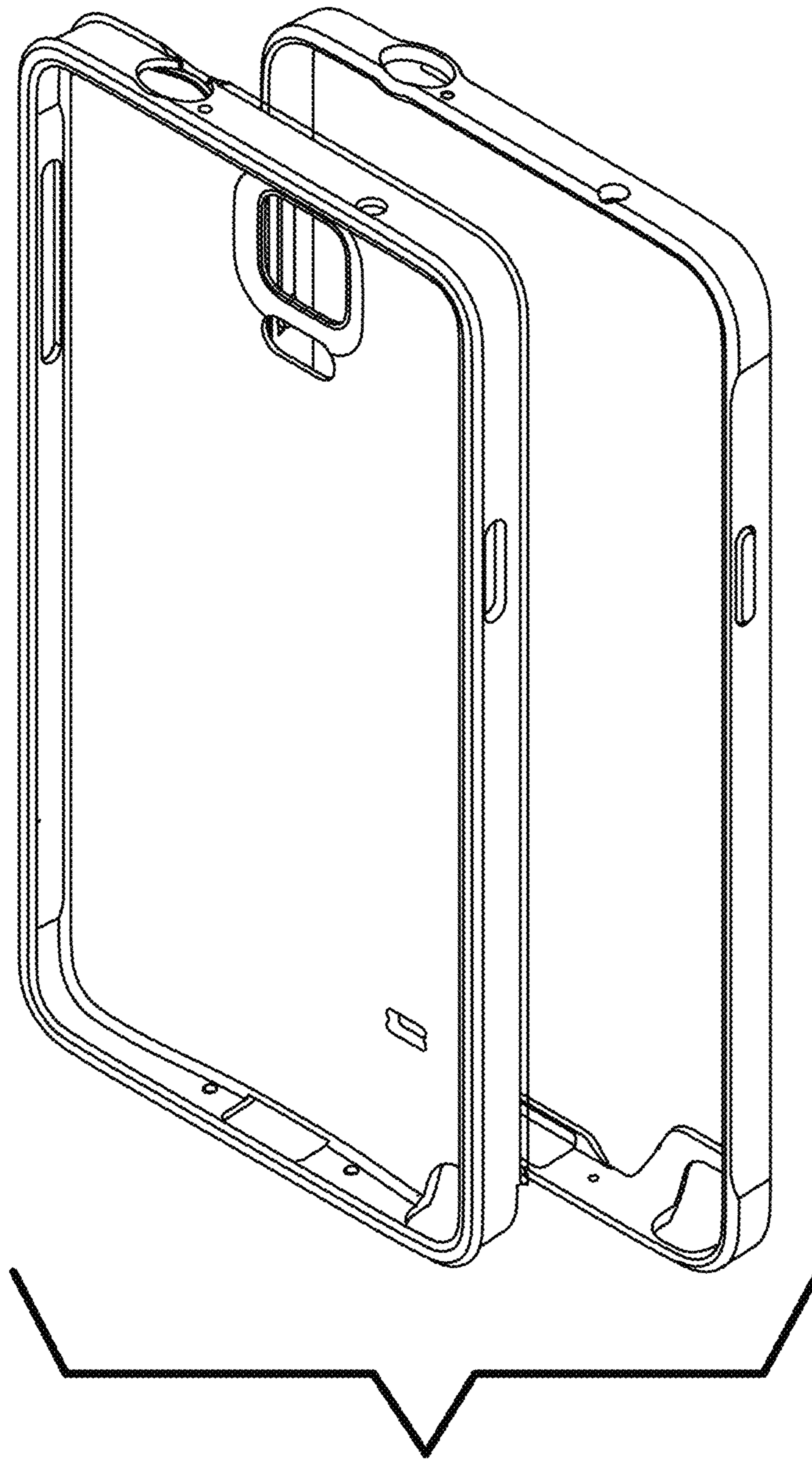

FIG. 10

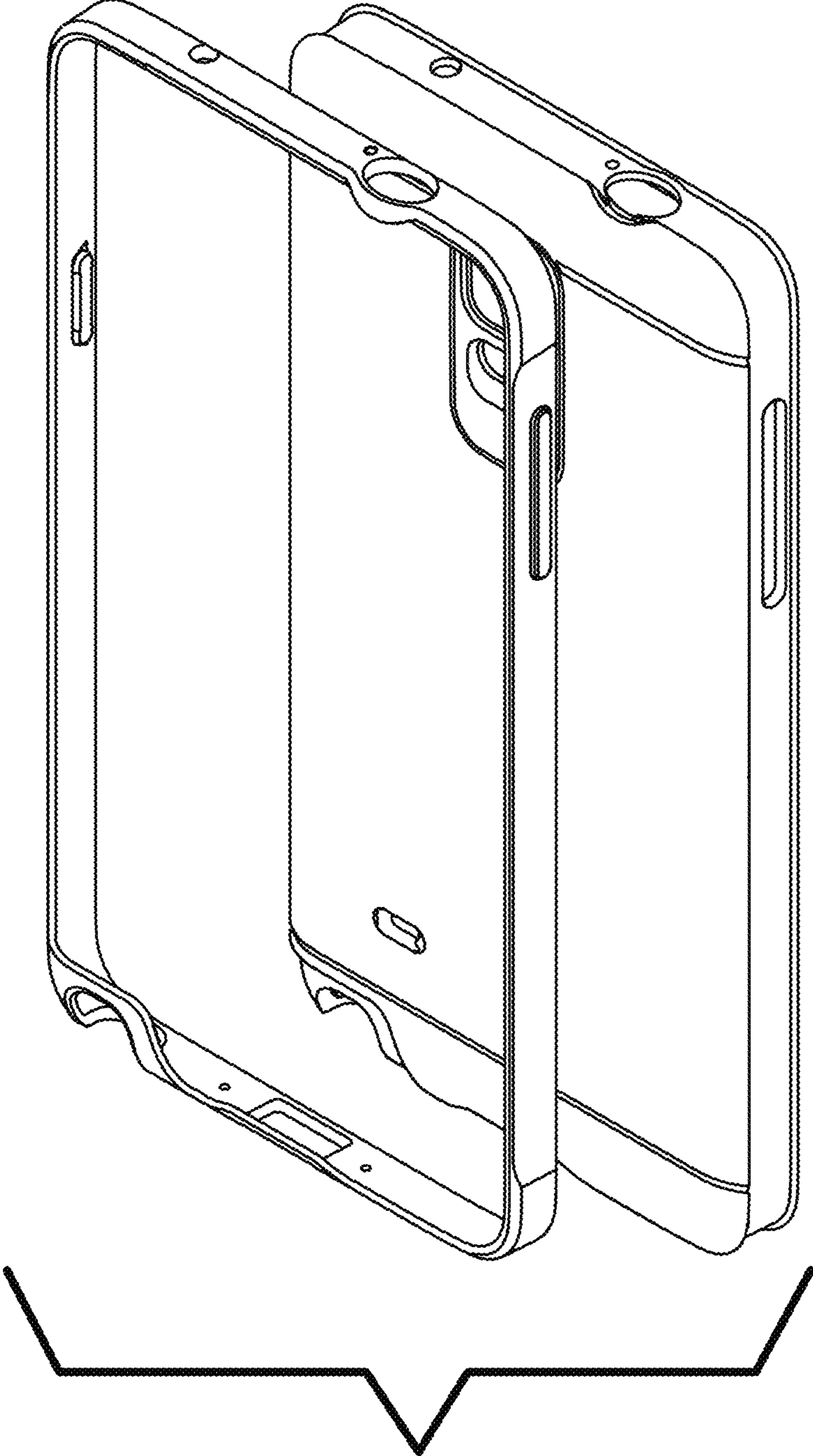

FIG. 11

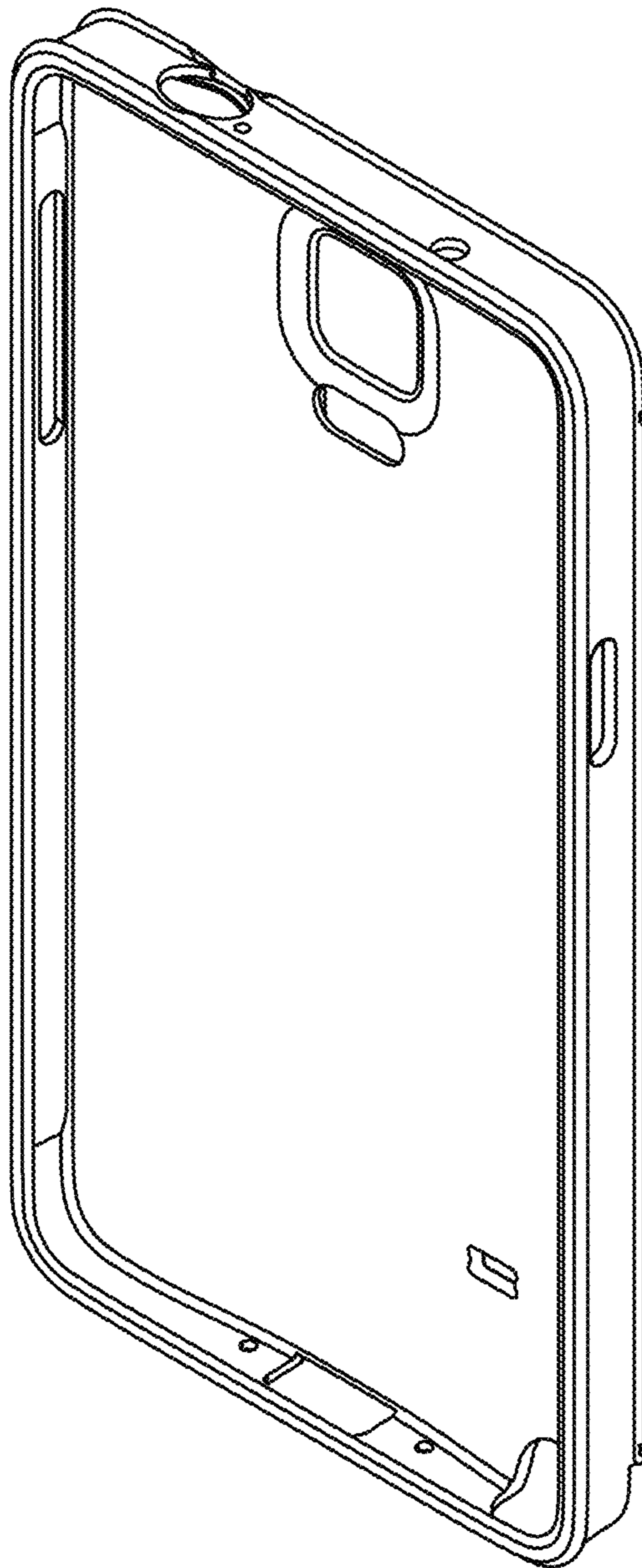

FIG. 12

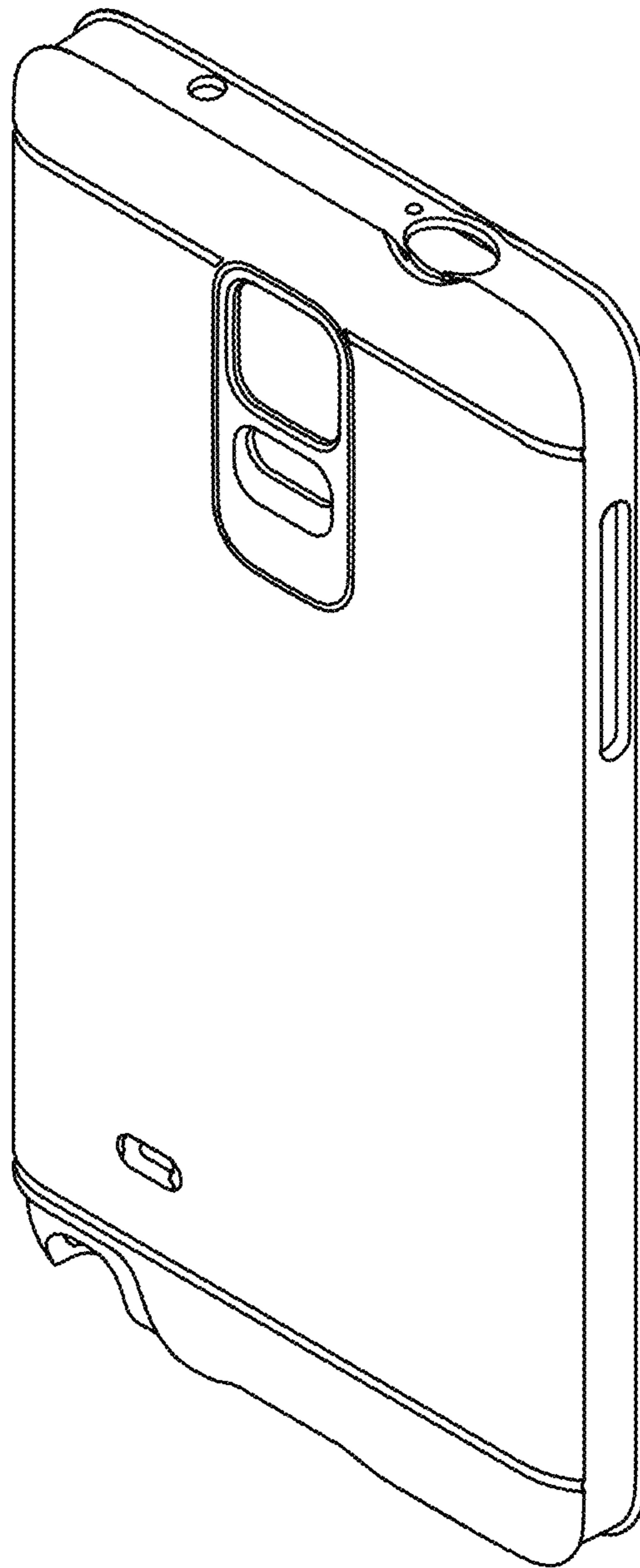

FIG. 13

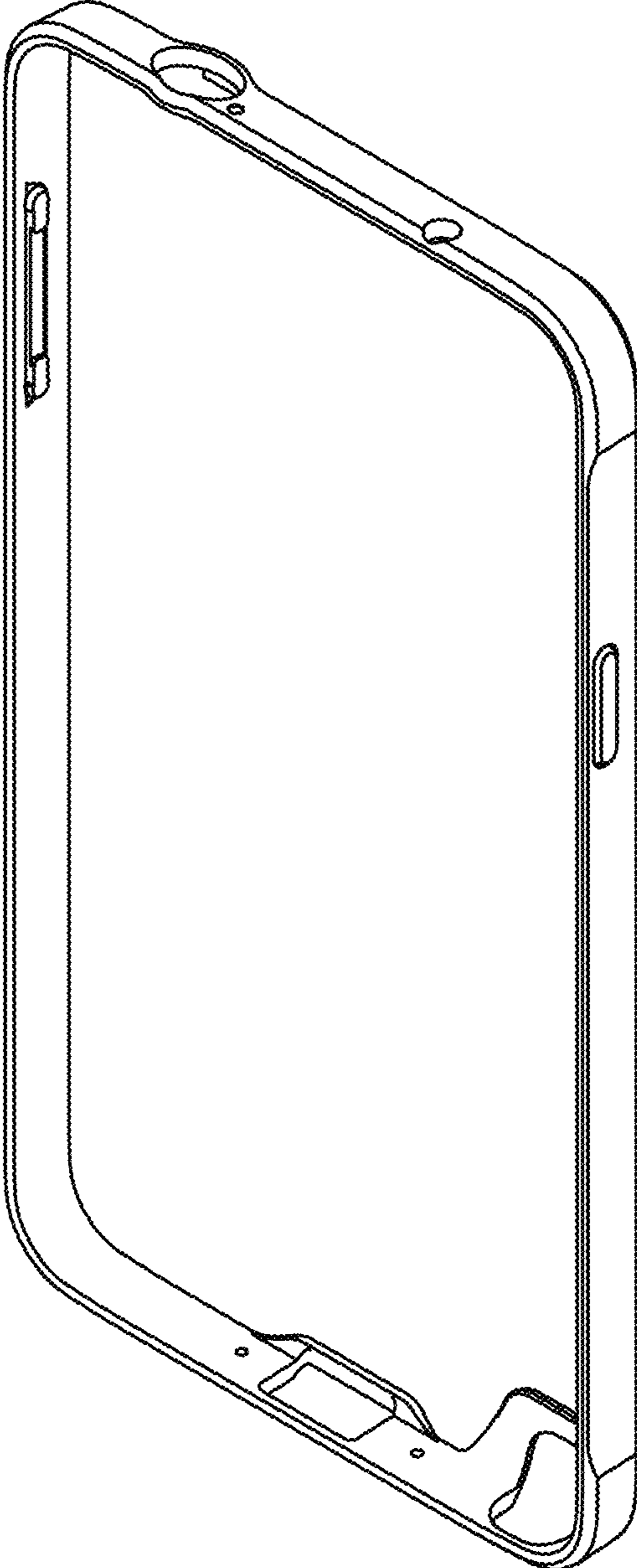

FIG. 14

