



US00D791736S

(12) **United States Design Patent** (10) **Patent No.:** **US D791,736 S**  
**Schoolmeester et al.** (45) **Date of Patent:** **\*\* Jul. 11, 2017**

(54) **SOUNDBAR**  
(71) Applicant: **Bose Corporation**, Framingham, MA (US)  
(72) Inventors: **Mark Schoolmeester**, Cumberland, RI (US); **Seth N. Green**, Newton, MA (US)  
(73) Assignee: **Bose Corporation**, Framingham, MA (US)  
(\*\*) Term: **15 Years**

(21) Appl. No.: **29/547,351**  
(22) Filed: **Dec. 3, 2015**  
(51) **LOC (10) Cl.** ..... **14-01**  
(52) **U.S. Cl.**  
USPC ..... **D14/214**; D24/204; D24/210  
(58) **Field of Classification Search**  
USPC ..... D14/168, 188, 194, 195, 196, 204, 210, D14/211, 212, 213, 214, 215, 216  
CPC ..... B60R 11/0217; G06F 1/1688; G10K 9/22; G10K 11/004; H03F 1/327; H04M 1/03; H04M 1/035; H04N 5/642; H04N 21/4852; H04S 3/00; H04S 7/30; H04R 1/02; H04R 1/06; H04R 1/021; H04R 1/025; H04R 1/026; H04R 1/028; H04R 1/105; H04R 1/323; H04R 1/403; H04R 1/2803; H04R 1/2834; H04R 5/02; H04R 7/20; H04R 9/06; H04R 9/025; H04R 2201/021; H04R 2400/00; H04R 2400/07; H04R 2499/11; H04R 2499/13; H04R 2499/15  
See application file for complete search history.

(56) **References Cited**  
U.S. PATENT DOCUMENTS  
D538,259 S \* 3/2007 Okamura ..... D14/172  
D660,284 S 5/2012 Carbone  
D681,606 S \* 5/2013 Nishii ..... D14/214

D688,231 S \* 8/2013 Nishii ..... D14/214  
D715,768 S \* 10/2014 Ryu ..... D14/211  
D739,386 S \* 9/2015 Gattinger ..... D14/210  
D739,845 S \* 9/2015 Hwang ..... D14/214  
D743,940 S \* 11/2015 Yang ..... D14/214  
D754,100 S \* 4/2016 McManigal ..... D14/214  
D756,968 S \* 5/2016 Huang ..... D14/214  
D764,440 S \* 8/2016 Xin ..... D14/214  
D768,603 S \* 10/2016 Kim ..... D14/214  
(Continued)

**FOREIGN PATENT DOCUMENTS**

TW D119701 11/2007

**OTHER PUBLICATIONS**

Bose Lifestyle 650, announced Oct. 15, 2016 [online], [site visited Feb. 2, 2017]. Available from internet, URL: <[https://www.amazon.com/Bose-Lifestyle-Entertainment-System-Black/dp/B01KZH0W3I/ref=cm\\_cr\\_arp\\_d\\_product\\_top?ie=UTF8](https://www.amazon.com/Bose-Lifestyle-Entertainment-System-Black/dp/B01KZH0W3I/ref=cm_cr_arp_d_product_top?ie=UTF8)>.\*  
(Continued)

*Primary Examiner* — Keli L Hill  
*Assistant Examiner* — Karra S Johnson

(57) **CLAIM**  
The ornamental design for soundbar, substantially as shown and described.

**DESCRIPTION**

FIG. 1 is a perspective view of a soundbar as seen from the front, top and side;  
FIG. 2 is a front view thereof;  
FIG. 3 is a rear view thereof;  
FIG. 4 is a top view thereof;  
FIG. 5 is a bottom view thereof;  
FIG. 6 is an opposite side view thereof; and,  
FIG. 7 is a side view thereof.  
The dotted line portions of the drawings represent environmental structure only and form no part of the claimed design.

**1 Claim, 3 Drawing Sheets**

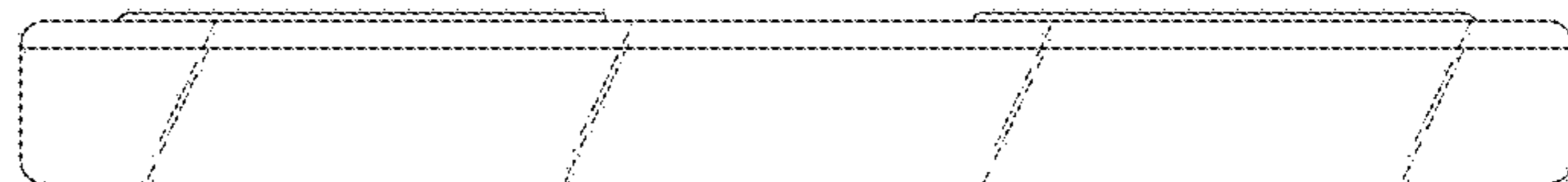
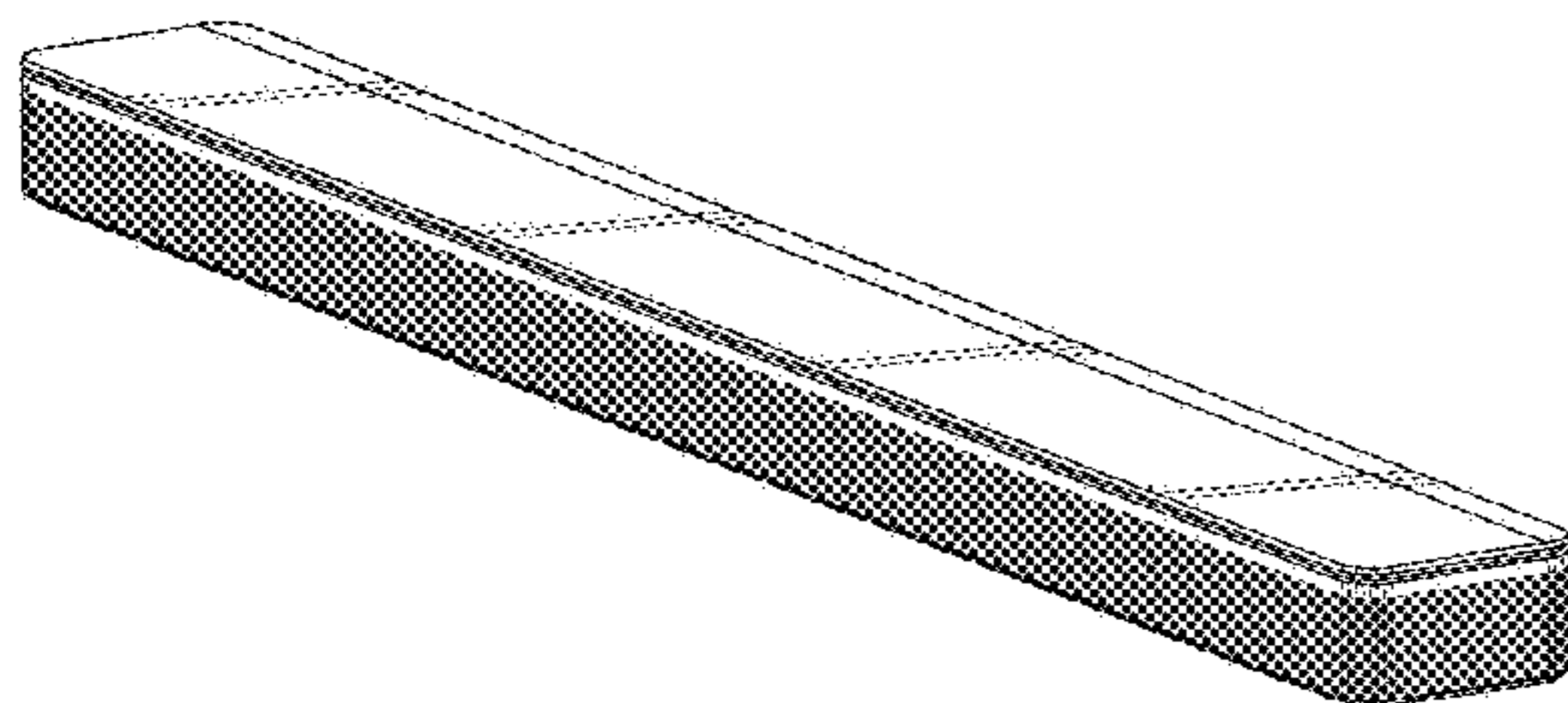

(56)

**References Cited**

U.S. PATENT DOCUMENTS

D773,436 S \* 12/2016 Kim ..... D14/214  
2012/0263335 A1 \* 10/2012 Breen ..... H04R 1/403  
381/387

OTHER PUBLICATIONS

Cedia 2016 (pp. 8-10), announced Sep. 19, 2016 [online], [site visited Feb. 2, 2017]. Available from internet, URL: <<http://www.highdefdigest.com/news/show/games/impressions/ultra-hd-bluray/sony-ubpx100es/KEF/blade-two/THX/ci/Atmos/dtsx/modulus/Monoprice/monolith-m1060/Integra/drxr1/bose/soundtouch-300/lifestyle-650/omnijewel-speakers/Control4/lg-sign>>.\*

SoundTouch 300 Soundbar, announced Sep. 13, 2016 [online], [site visited Feb. 2, 2017]. Available from internet, URL: <<http://www.businesswire.com/news/home/20160913006105/en/Bose-Introduces-Wireless-Soundbar-Surround-Sound-Systems>>.\*

TW Search Report dated Dec. 26, 2016 for TW Design Application 105302945, received Jan. 13, 2017.

\* cited by examiner

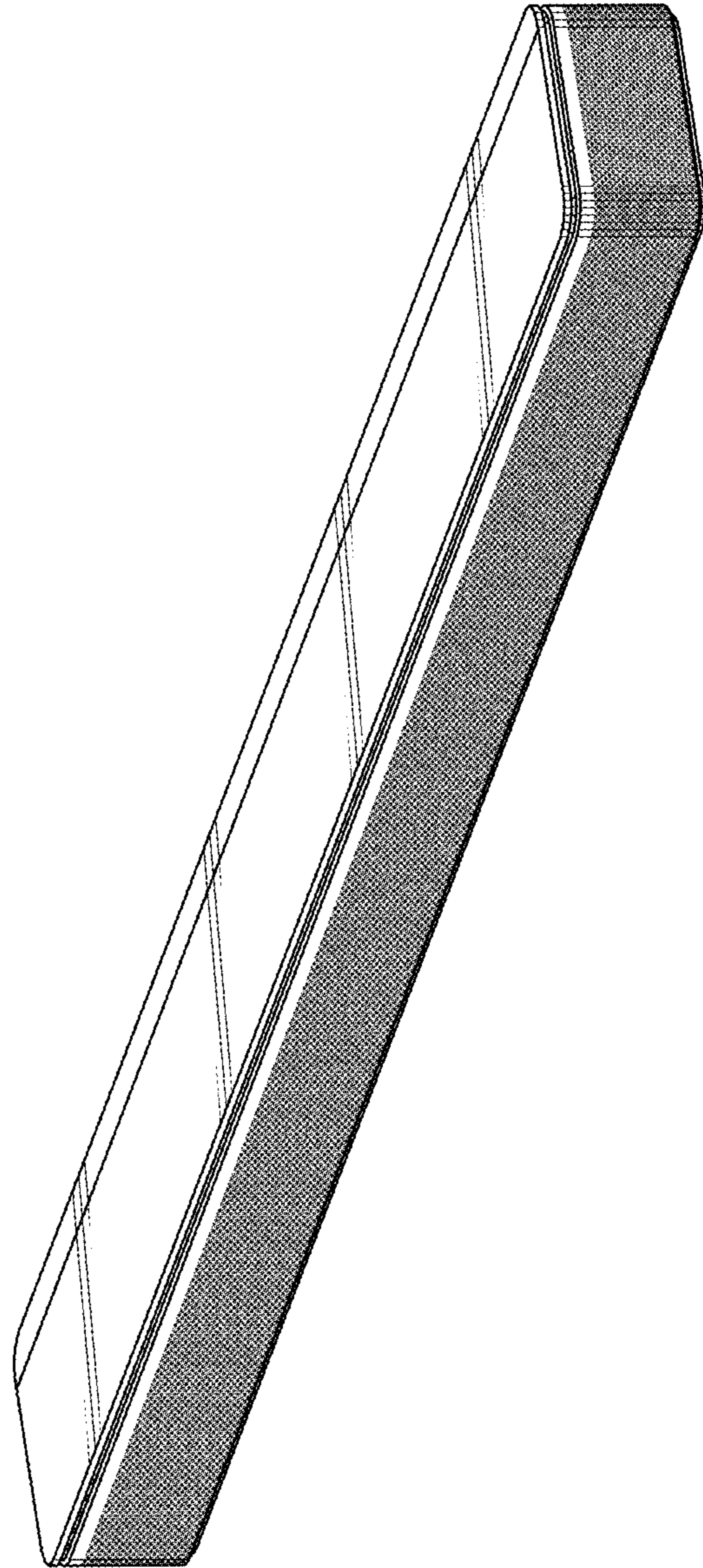

**FIG. 1**

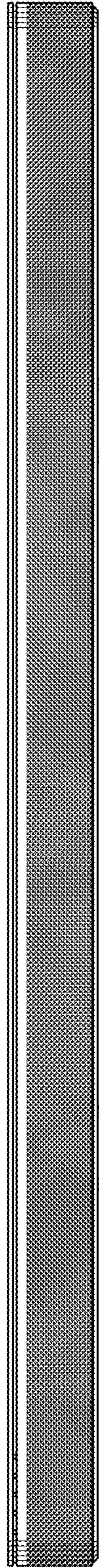

**FIG. 2**

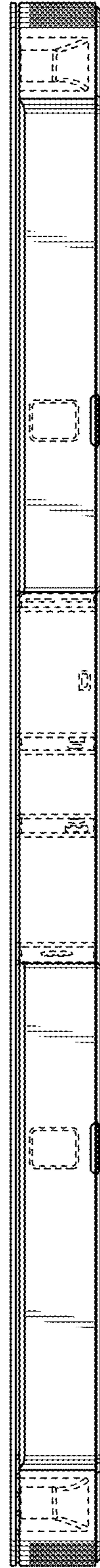

**FIG. 3**

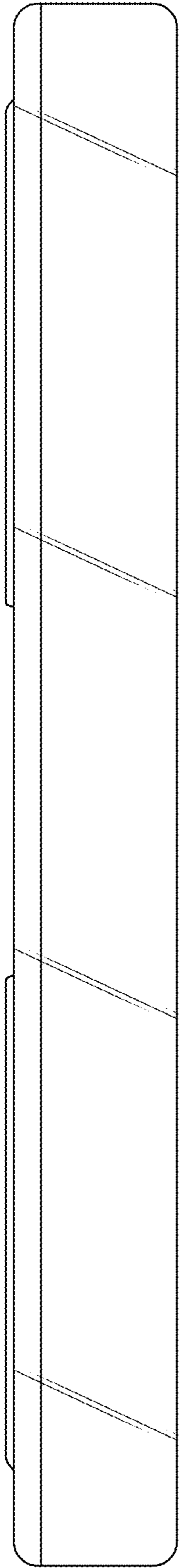

**FIG. 4**

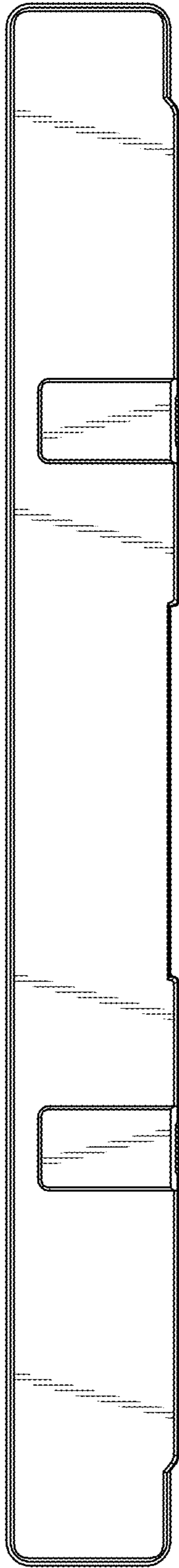

**FIG. 5**

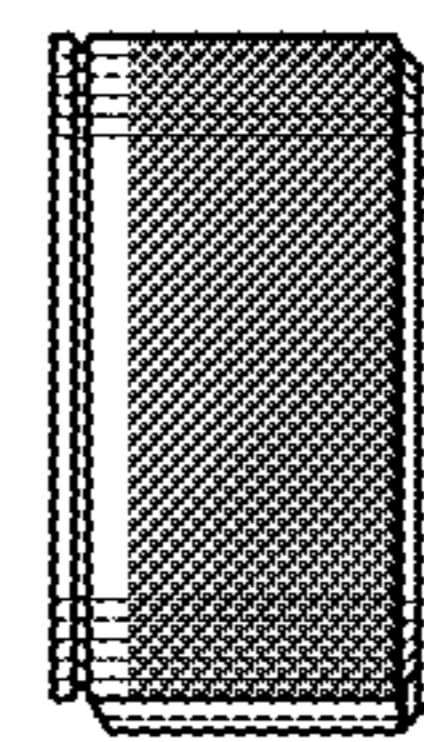

**FIG. 6**

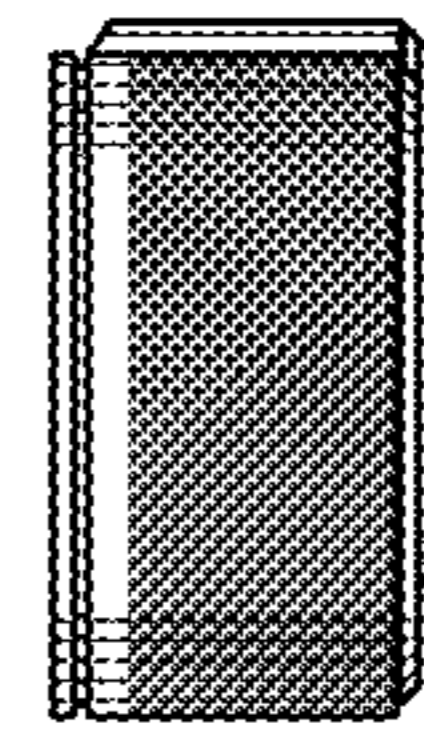

**FIG. 7**