



US00D791727S

(12) **United States Design Patent**
Choi et al.

(10) **Patent No.:** **US D791,727 S**
(45) **Date of Patent:** **** Jul. 11, 2017**

(54) **PORTABLE ELECTRONIC DEVICE**

- (71) Applicant: **Samsung Electronics Co., Ltd.**, Suwon-si (KR)
- (72) Inventors: **Kwangha Choi**, Seoul (KR); **Junhyuck Im**, Yongin-si (KR); **Jinsoo Kim**, Yongin-si (KR)
- (73) Assignee: **Samsung Electronics Co., Ltd.**, Suwon-si (KR)

(**) Term: **14 Years**

(21) Appl. No.: **29/513,453**

(22) Filed: **Dec. 31, 2014**

(30) **Foreign Application Priority Data**

Aug. 29, 2014 (KR) 30-2014-0042390

(51) **LOC (10) Cl.** **17-03**

(52) **U.S. Cl.**
USPC **D14/138 AA**

(58) **Field of Classification Search**
USPC D13/168; D14/138 G, 138 R, 138 AD, D14/203.1, 203.3, 203.5, 203.6, 203.7, D14/218, 248, 250, 315, 341, 342, 343, D14/344, 345, 346, 347, 420, 426, 496
CPC G06F 1/1626; H04M 1/72527; H04M 1/0266; H04M 1/185; H04M 1/0214
See application file for complete search history.

(56) **References Cited**

U.S. PATENT DOCUMENTS

- D291,804 S * 9/1987 George 455/556.1
 - D515,529 S * 2/2006 Beasley D14/138 AA
 - D563,941 S * 3/2008 Franck D14/147
- (Continued)

FOREIGN PATENT DOCUMENTS

- CN 301938859 S 5/2012
- CN 302133786 S 10/2012
- CN 302849666 S 6/2014

OTHER PUBLICATIONS

GSM Arena, Samsung Galaxy S5 Active—3D View, May 2014m
GSM Arena, http://www.gsmarena.com/samsung_galaxy_s5_active-3d-spin-6356.php.*

(Continued)

Primary Examiner — John Windmuller

Assistant Examiner — Benjamin Weeks

(74) *Attorney, Agent, or Firm* — NSIP Law

(57) **CLAIM**

We claim the ornamental design for a portable electronic device, as shown and described.

DESCRIPTION

FIG. 1 is a front perspective view of a portable electronic device showing our new design;
 FIG. 2 is a front view thereof;
 FIG. 3 is a rear view thereof;
 FIG. 4 is a left-side view thereof;
 FIG. 5 is a right-side view thereof;
 FIG. 6 is a top view thereof;
 FIG. 7 is a bottom view thereof;
 FIG. 8 is a rear perspective view thereof;
 FIG. 9 is an enlarged view of the encircled portion 9 in FIG. 1;
 FIG. 10 is an enlarged view of the encircled portion 10 in FIG. 4; and,
 FIG. 11 is an enlarged view of the encircled portion 11 in FIG. 4.

The short dash-dash broken lines in the figures represent unclaimed portions of the portable electronic device and form no part of the claimed design.
 In FIGS. 1, 4, 9, 10 and 11, the dot-dash broken lines encircling portions of the claimed design that are illustrated in enlargements form no part of the claimed design.

1 Claim, 11 Drawing Sheets

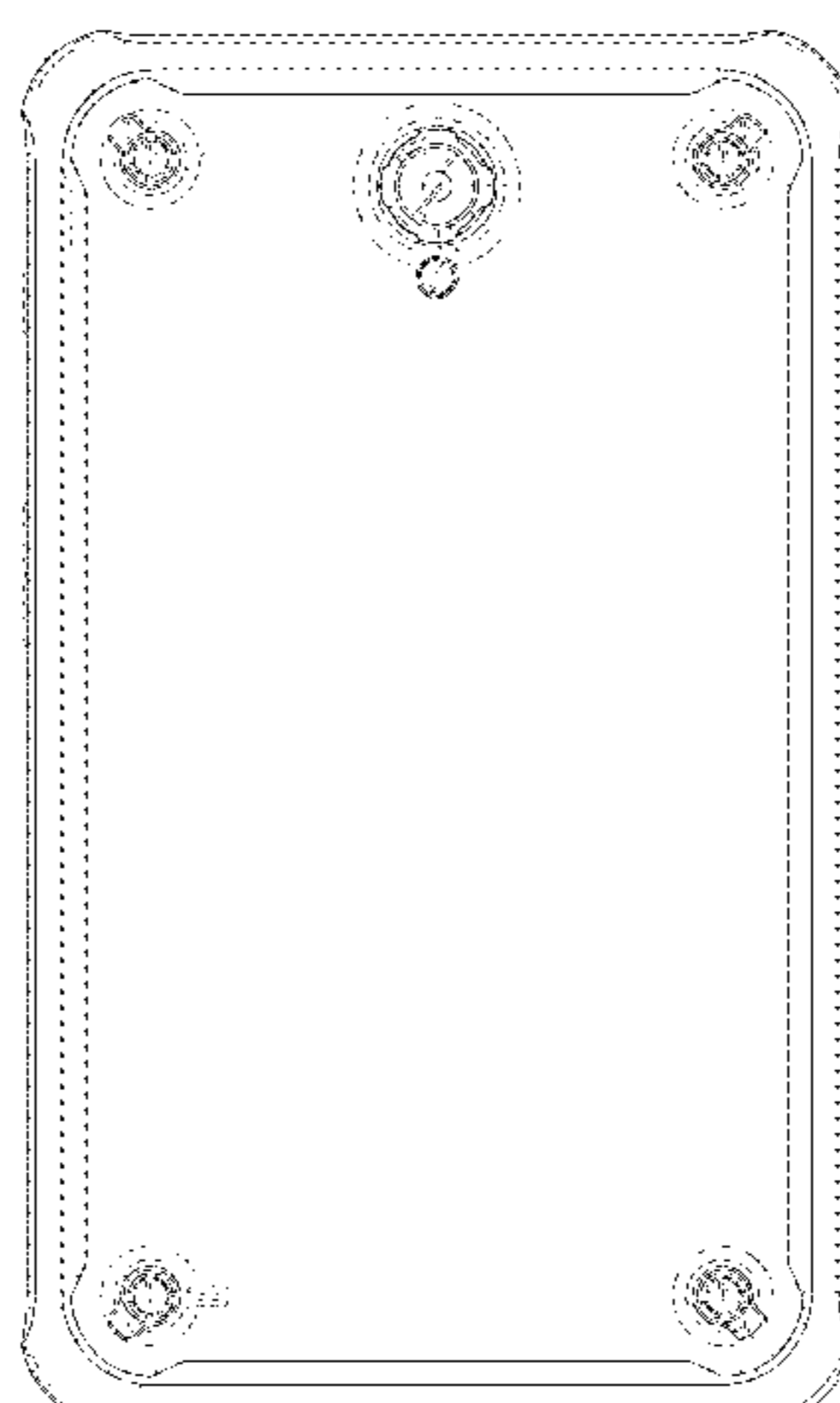
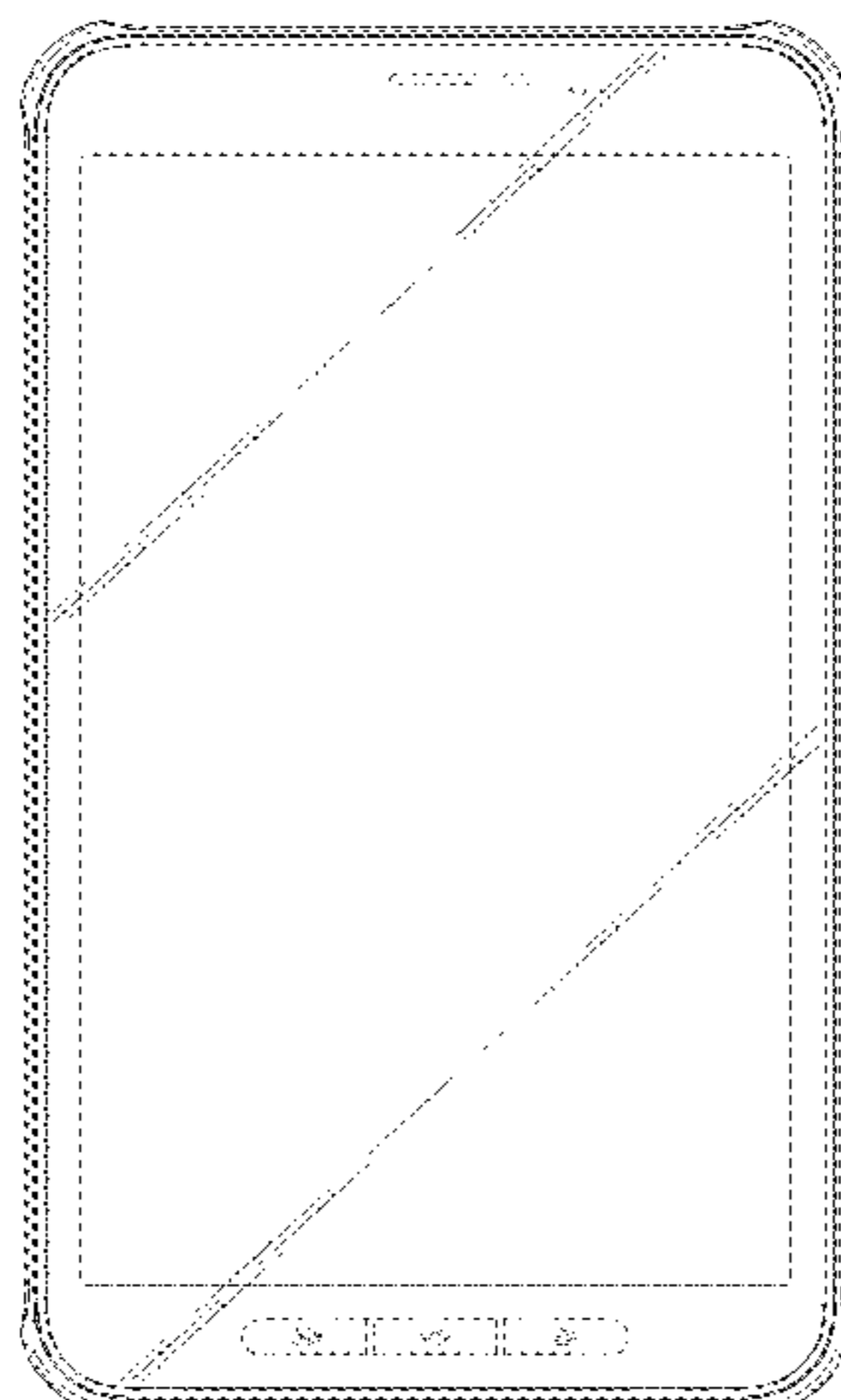

(56)

References Cited

U.S. PATENT DOCUMENTS

D583,787 S * 12/2008 Kim D14/138 AB
 D589,953 S * 4/2009 Turner D14/248
 D645,040 S * 9/2011 Morton D14/341
 D663,711 S * 7/2012 Lee D14/138 G
 D663,724 S * 7/2012 Lee D14/248
 D668,628 S * 10/2012 Ha D14/138 G
 D684,553 S * 6/2013 Kim D14/138 G
 D684,554 S * 6/2013 Park D14/138 G
 D686,586 S * 7/2013 Cho D14/138 G
 D697,890 S * 1/2014 Choe D14/138 G
 D701,203 S * 3/2014 Katori D14/341
 D703,179 S * 4/2014 Choe D14/138 G
 D719,940 S * 12/2014 Lee D14/248
 D726,699 S * 4/2015 Lee D14/248
 D726,700 S * 4/2015 Lee D14/248
 D738,361 S * 9/2015 Lee D14/248
 D741,830 S * 10/2015 Lee D14/138 G
 D749,567 S * 2/2016 Lee D14/203.4
 D753,105 S * 4/2016 Chang D14/203.7
 D754,124 S * 4/2016 Kim D14/341
 D757,704 S * 5/2016 Roberts D14/250
 D763,252 S * 8/2016 Lee D14/341
 D763,837 S * 8/2016 Choe D14/248
 D766,889 S * 9/2016 Akana D14/203.7
 D768,101 S * 10/2016 Zhang D14/138 G
 D770,431 S * 11/2016 Lee D14/248
 2012/0309473 A1 * 12/2012 Choo G06F 1/1656
 455/575.7

OTHER PUBLICATIONS

Serban, Alex. "Panasonic ToughPad FZ-G1 and JT-B1" Excerpt from "Top 8 Rugged Tablets [2013]" Technology Personalized. Mar. 6, 2013. <<http://techpp.com/2013/03/06/top-rugged-tablets>>.

* cited by examiner

FIG. 1

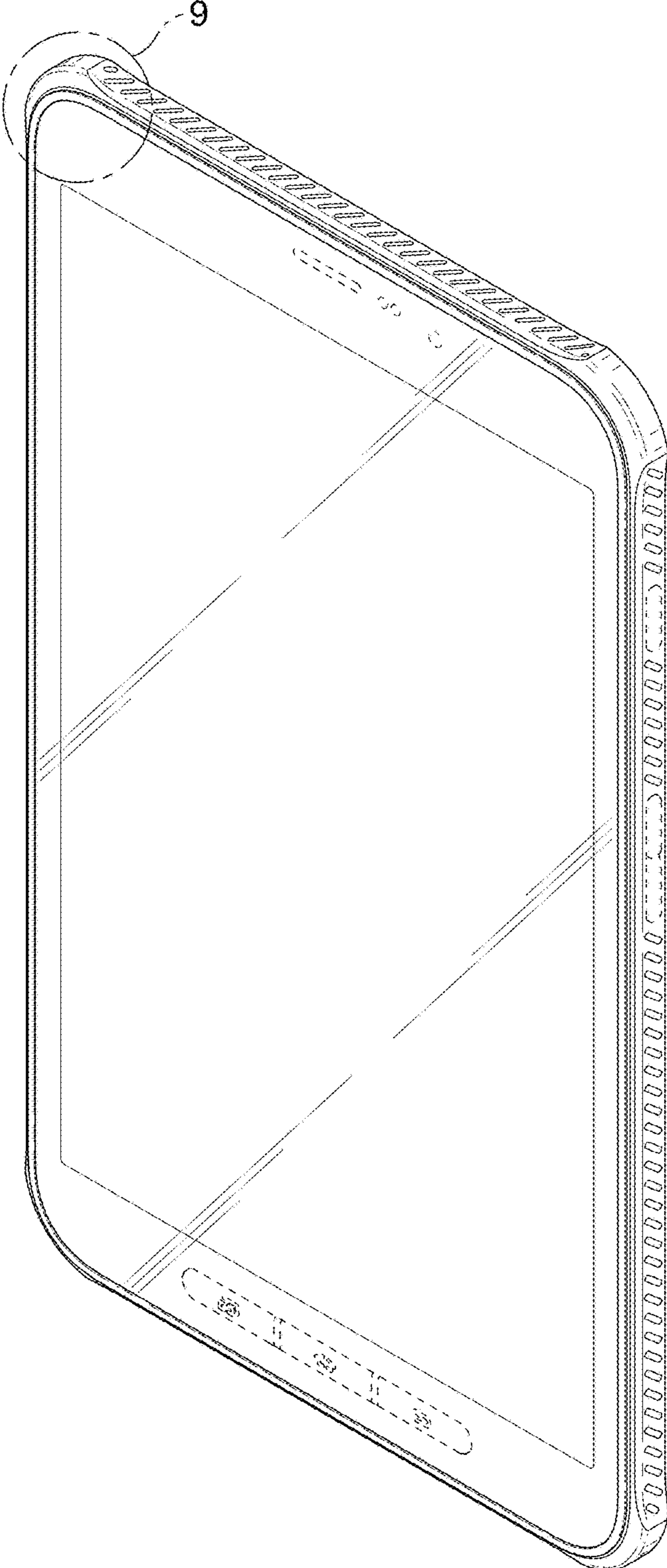

FIG. 2

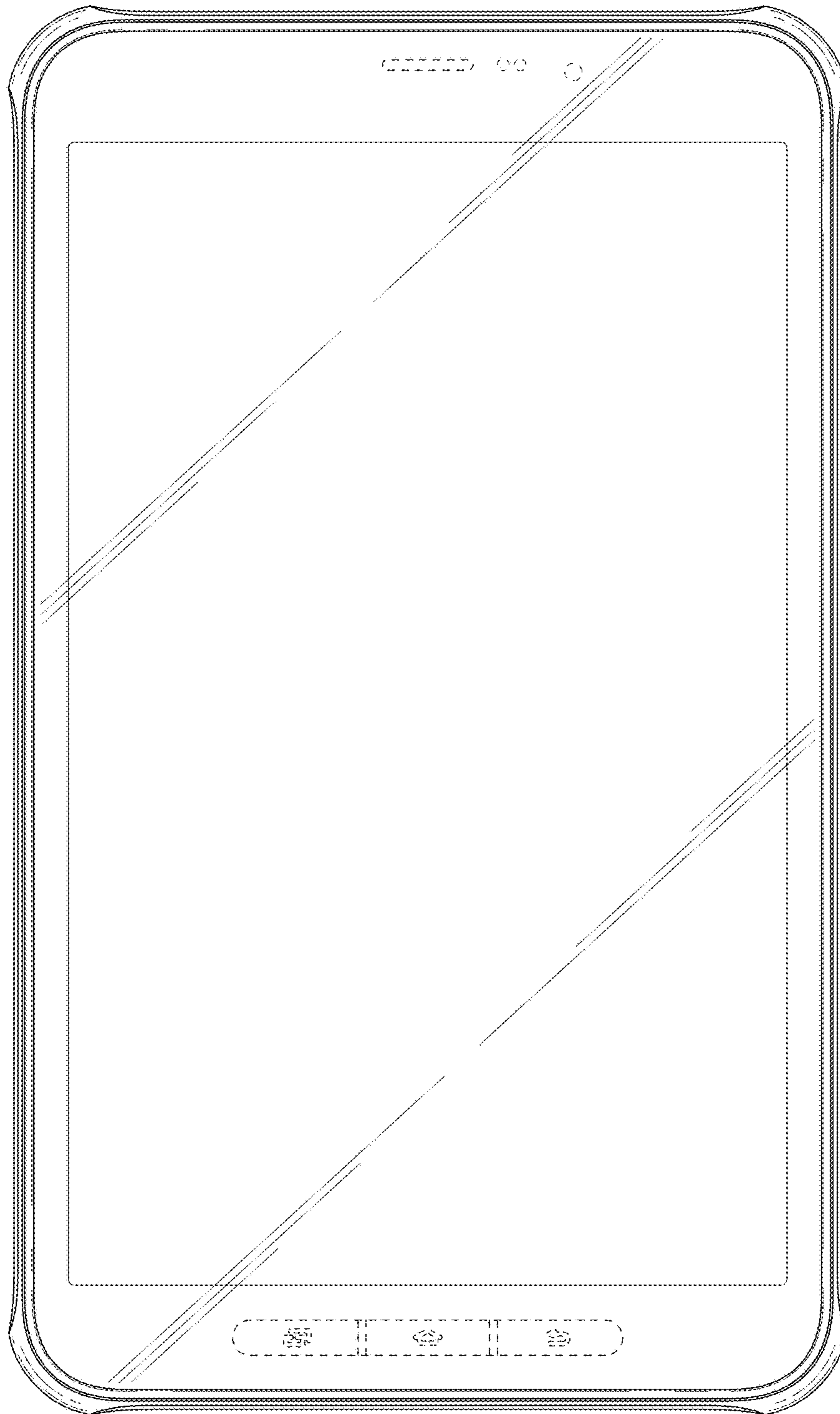

FIG. 3

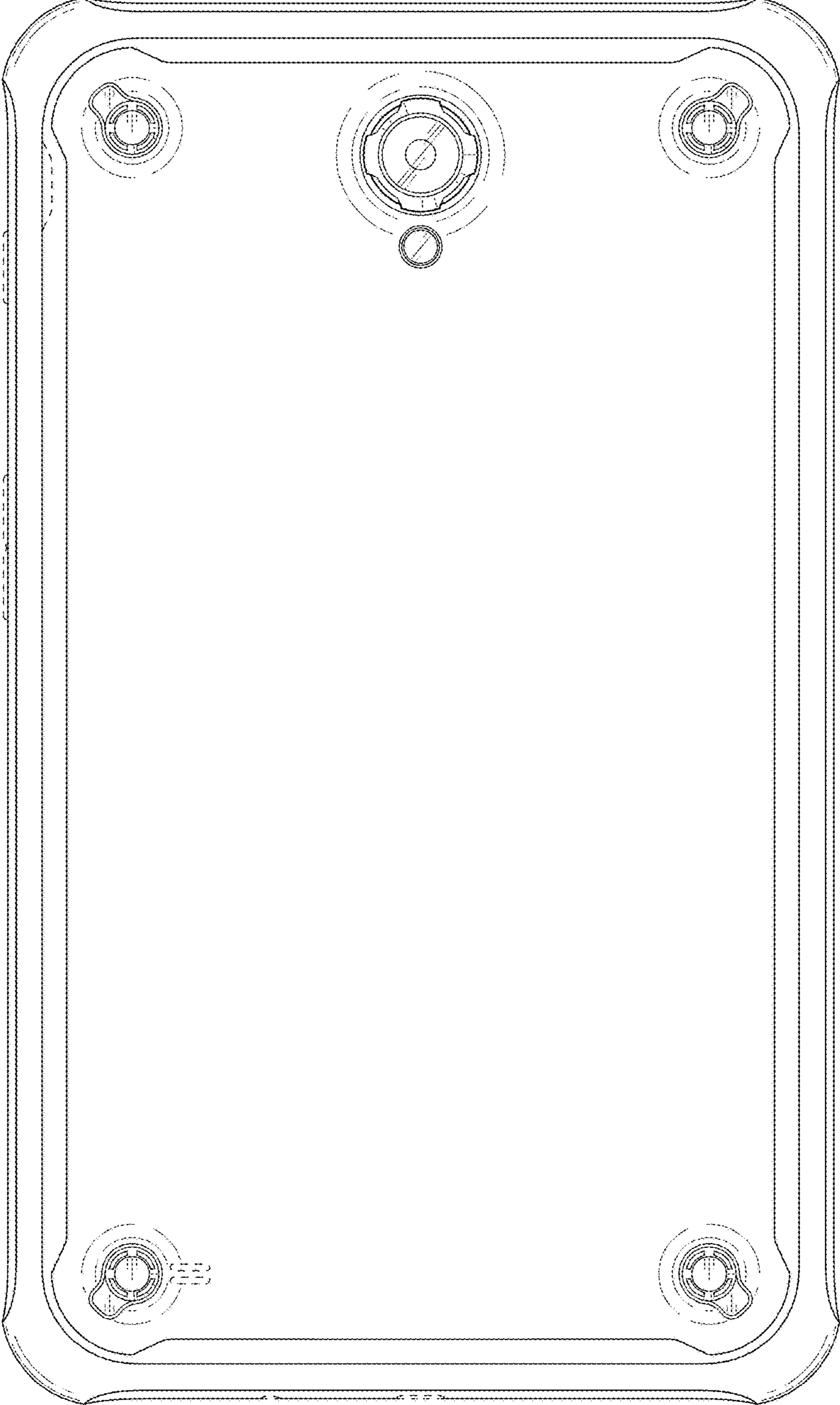

FIG. 4

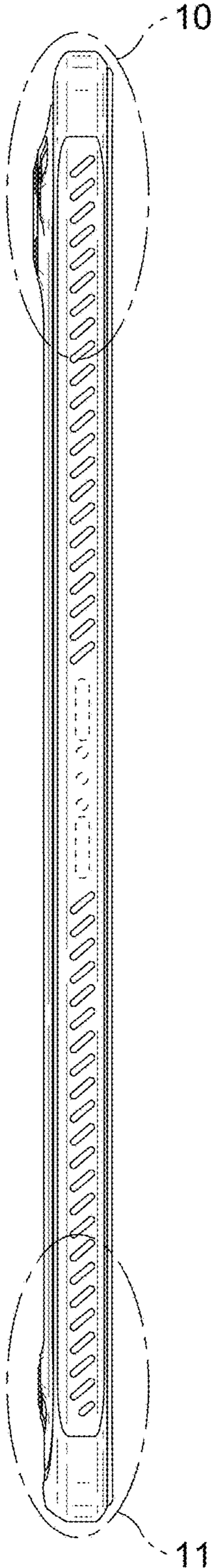

FIG. 5

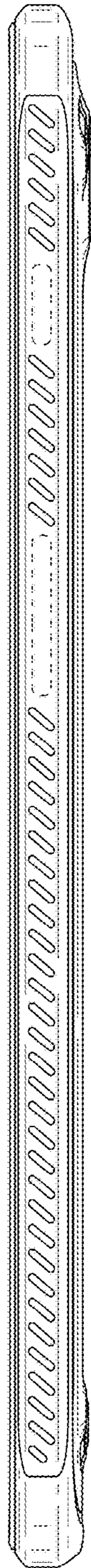

FIG. 6

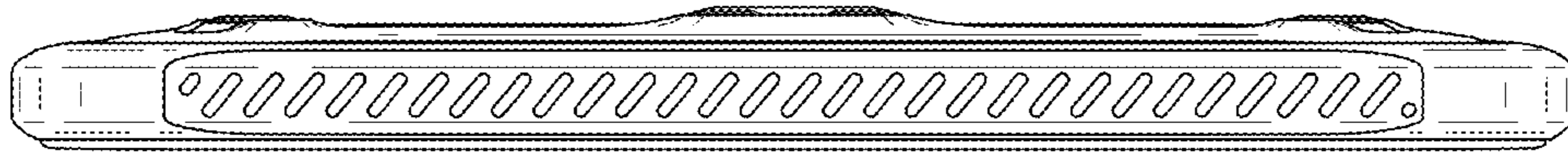

FIG. 7



FIG. 8

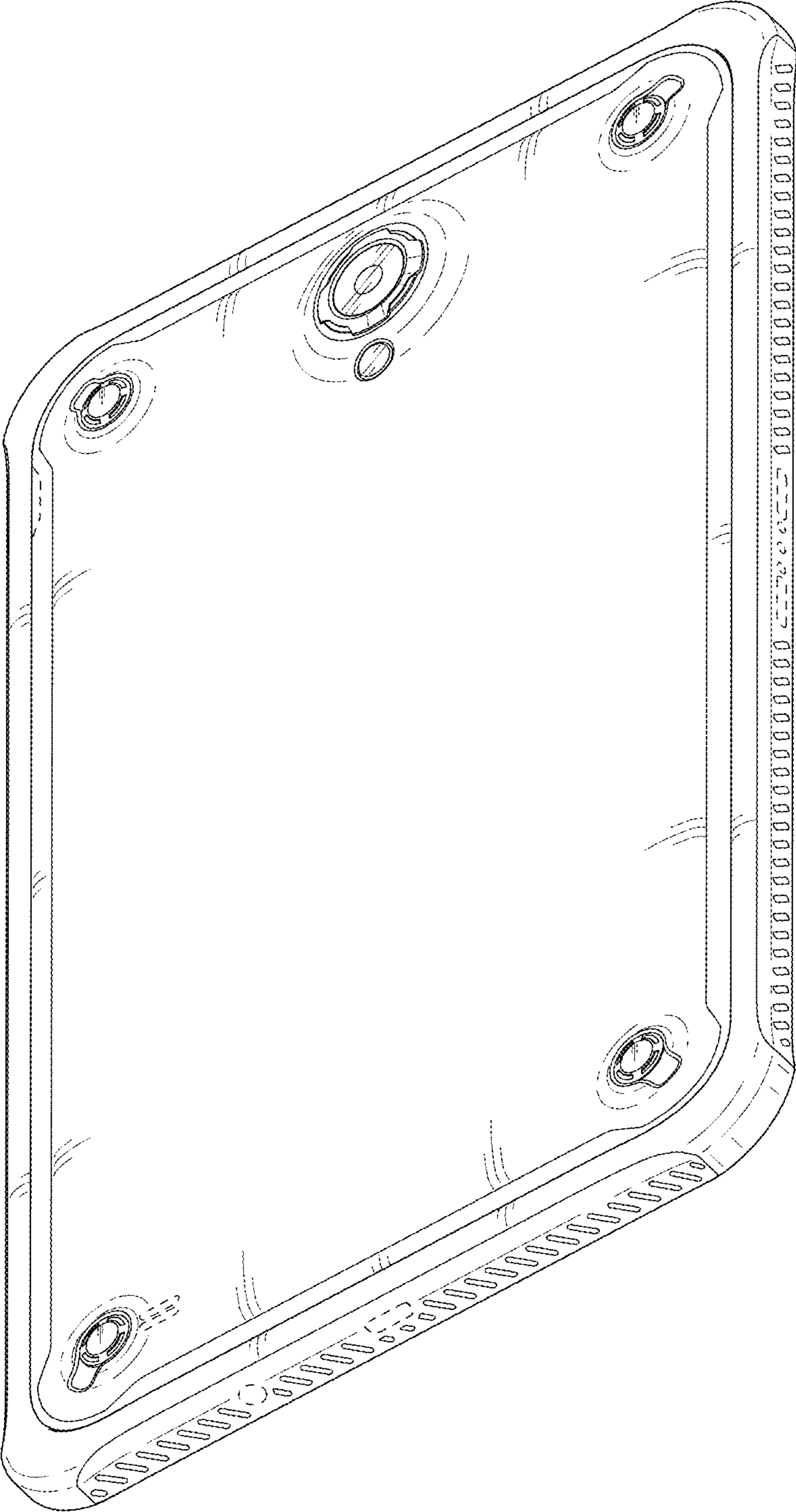

FIG. 9

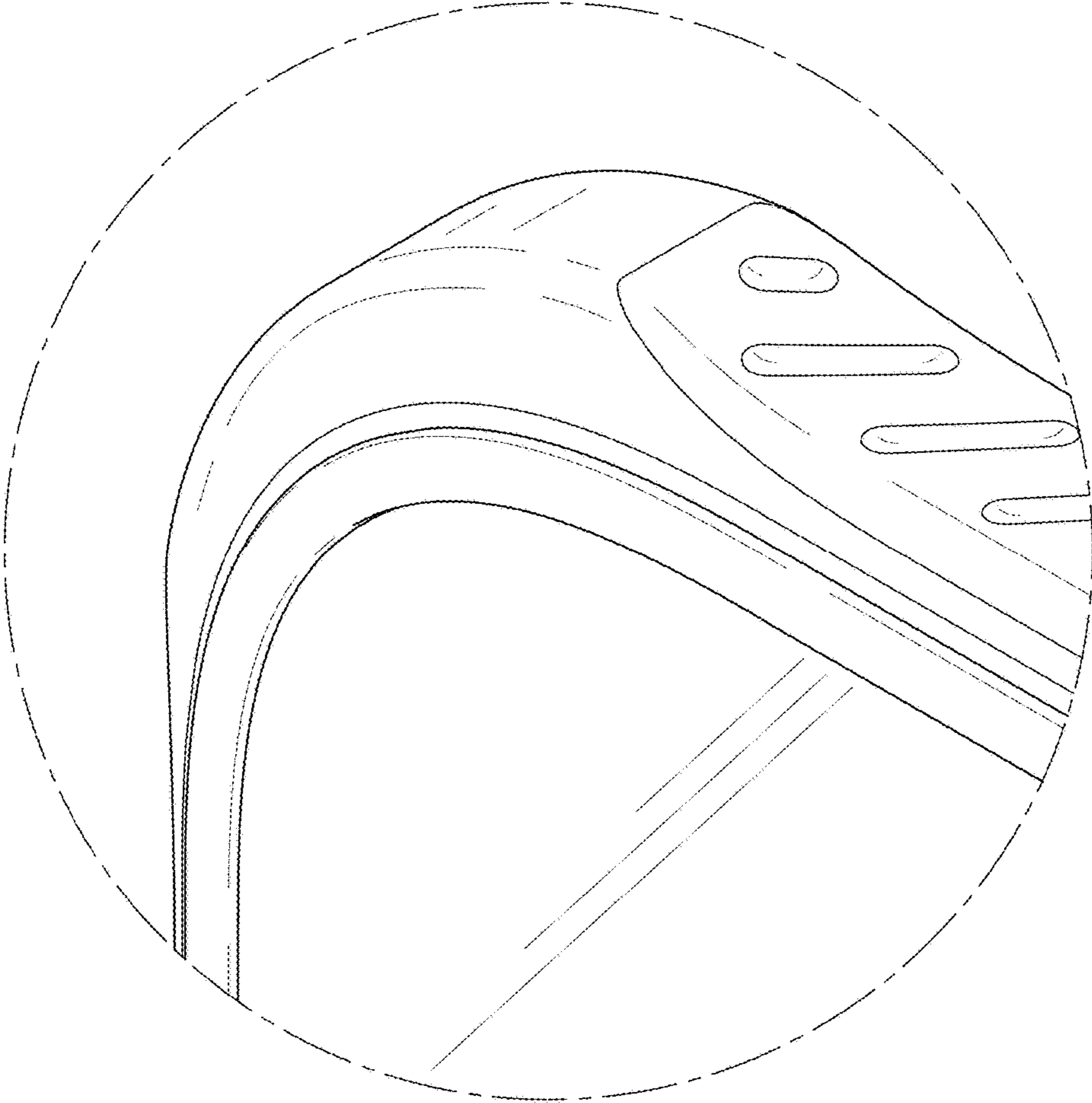

FIG. 10

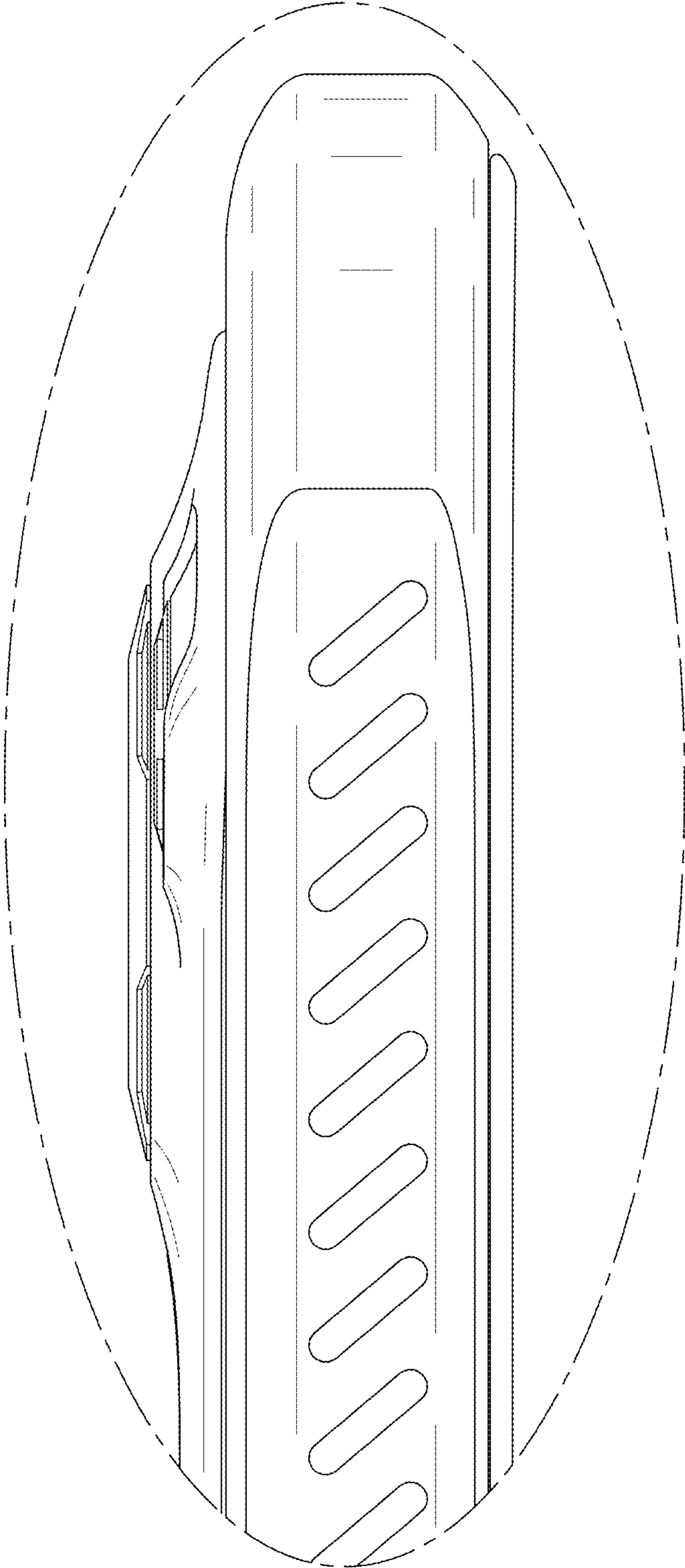

FIG. 11

