



US00D791658S

(12) **United States Design Patent**
Ito et al.

(10) **Patent No.:** **US D791,658 S**
(45) **Date of Patent:** **** Jul. 11, 2017**

(54) **TRUCK MIRROR**

(71) Applicant: **International Truck Intellectual Property Company, LLC**, Lisle, IL (US)

(72) Inventors: **Chris Isamu Ito**, Sugar Grove, IL (US); **Glen Joel Durmisevich**, Rochester Hills, MI (US); **Rudolph D. Gonzalez**, Wheaton, IL (US); **Robert P. Scott**, Aurora, IL (US)

(73) Assignee: **Navistar Canada, Inc.** (CA)

(**) Term: **15 Years**

(21) Appl. No.: **29/565,906**

(22) Filed: **May 25, 2016**

(51) **LOC (10) Cl.** **12-16**

(52) **U.S. Cl.**

USPC **D12/187**

(58) **Field of Classification Search**

USPC D12/187, 188-189; D6/300, 309

CPC B60R 1/076; G02B 7/182; G02B 5/08;

G02B 7/18

See application file for complete search history.

(56) **References Cited**

U.S. PATENT DOCUMENTS

D462,305 S 9/2002 Abalos et al.
D696,170 S 12/2013 Ito et al.

D727,229 S *	4/2015	Varga	D12/187
D731,379 S *	6/2015	Behmer	D12/187
D744,918 S *	12/2015	Di Buduo	D12/187
D746,196 S *	12/2015	Di Buduo	D12/187
D746,197 S *	12/2015	Nissl	D12/187
D751,477 S *	3/2016	Ting	D12/187
D761,172 S *	7/2016	Kim	D12/187
D761,173 S *	7/2016	Faghihzadeh	D12/187
D777,068 S *	1/2017	Sterner	D12/187

* cited by examiner

Primary Examiner — Katrina A Betton

(74) *Attorney, Agent, or Firm* — Jeffrey P. Calfa; Mark C. Bach

(57) **CLAIM**

The ornamental design for a truck mirror, as shown and described.

DESCRIPTION

FIG. 1 is a perspective view of the truck mirror showing my/our new design;

FIG. 2 is a bottom view of the truck mirror of FIG. 1;

FIG. 3 is a top plan view of the truck mirror of FIG. 1;

FIG. 4 is a rear view of the truck mirror of FIG. 1;

FIG. 5 is a front view of the truck mirror of FIG. 1;

FIG. 6 is a right side view of the truck mirror of FIG. 1; and,

FIG. 7 is a left side view of the truck mirror of FIG. 1.

1 Claim, 3 Drawing Sheets

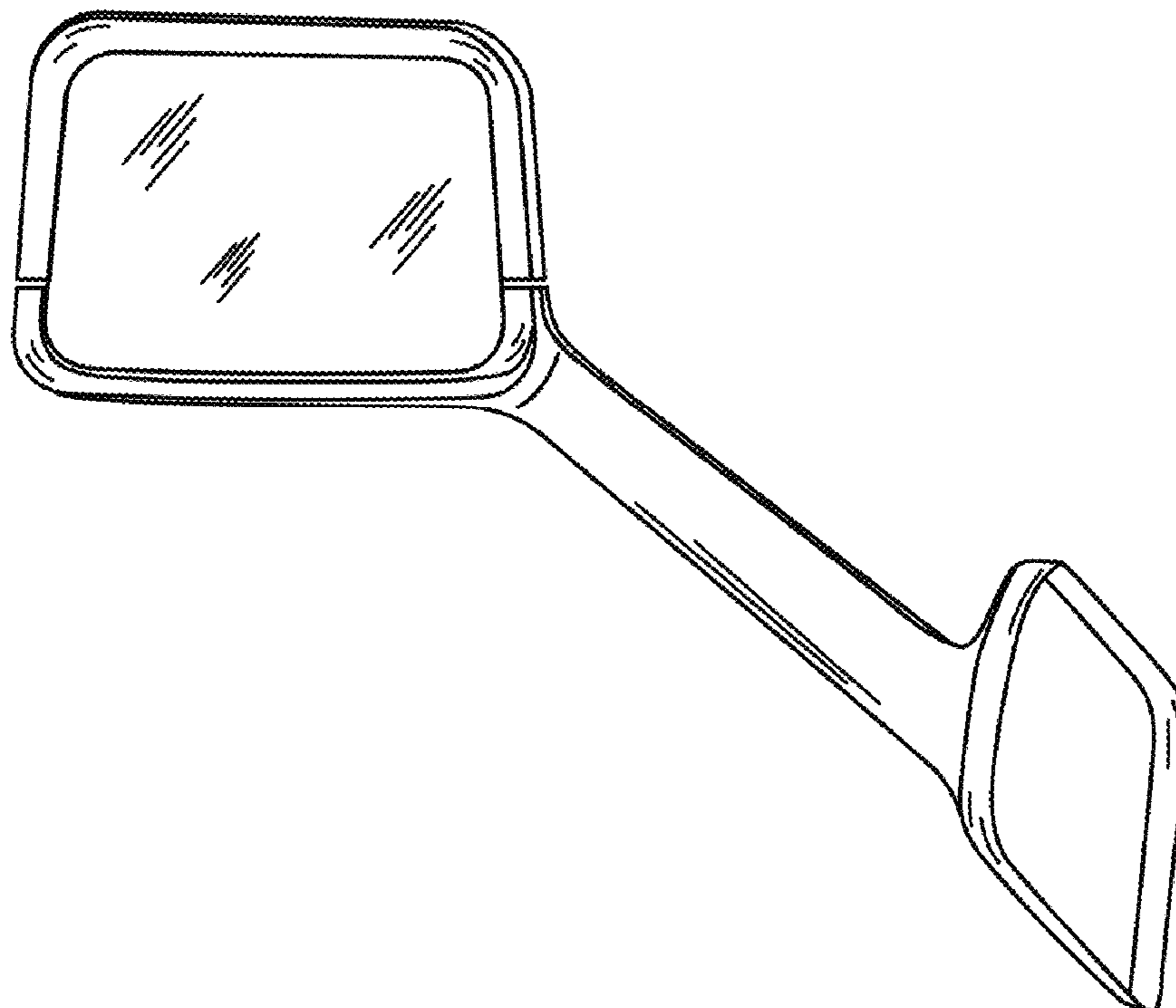

FIG. 1

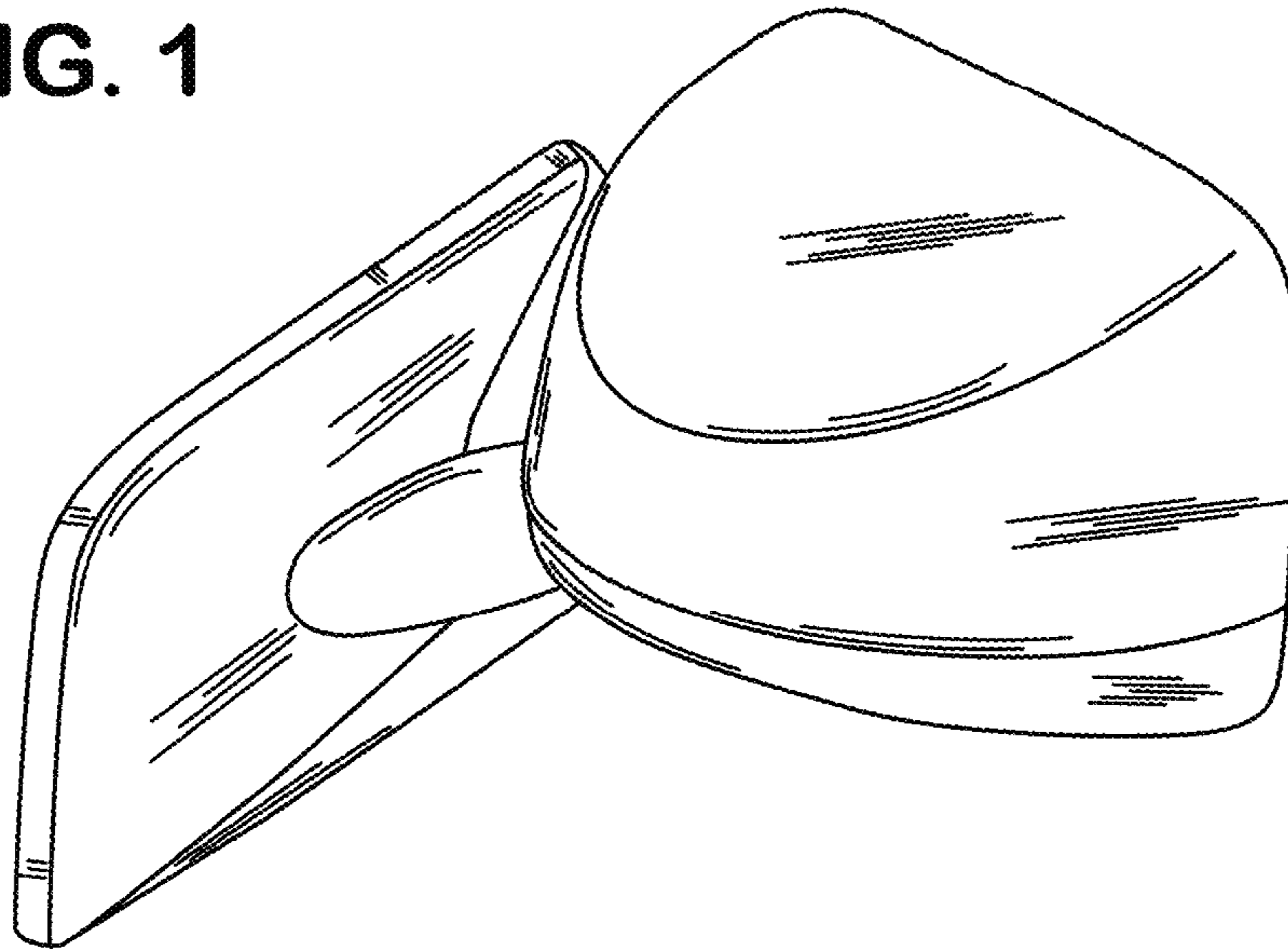

FIG. 2

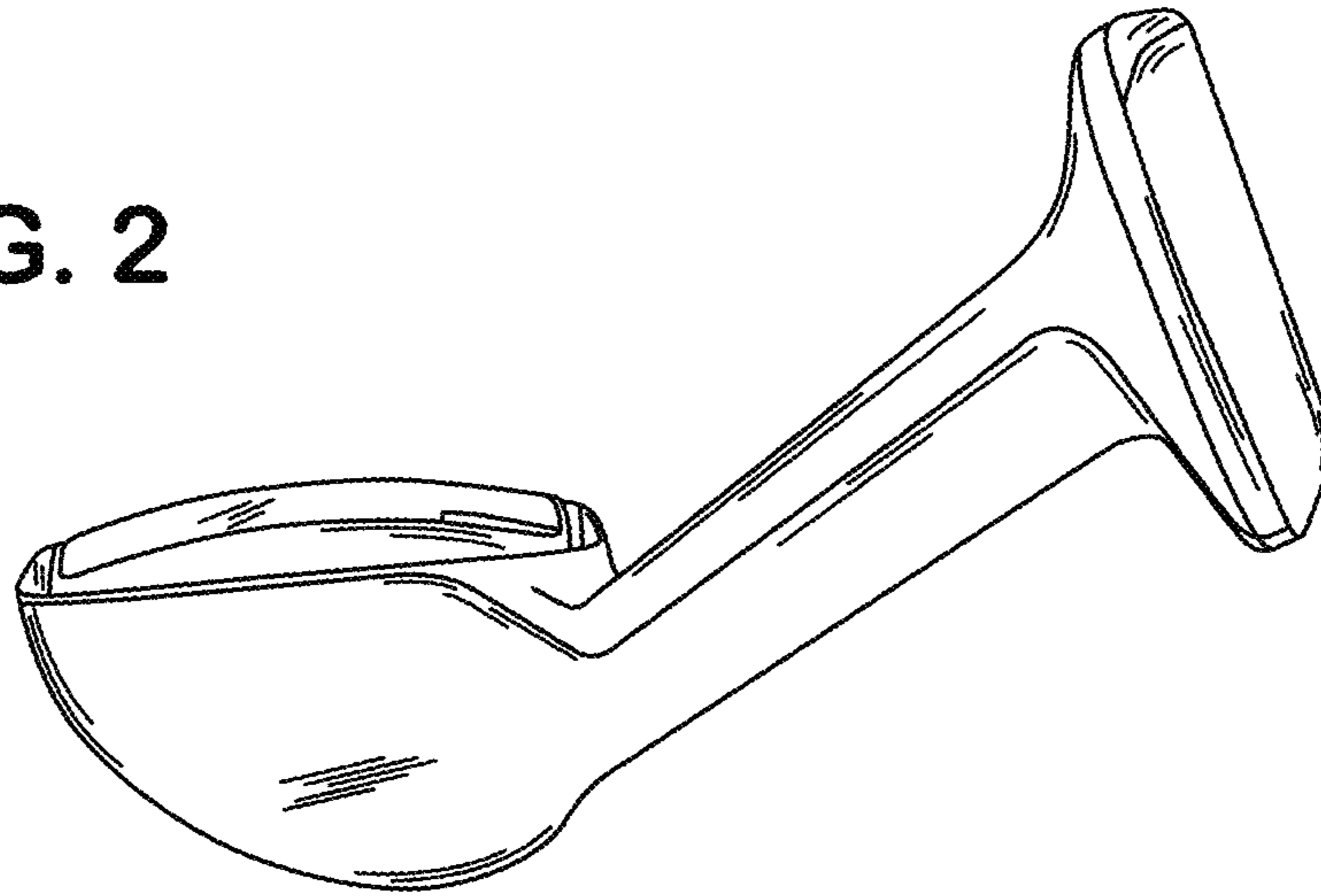
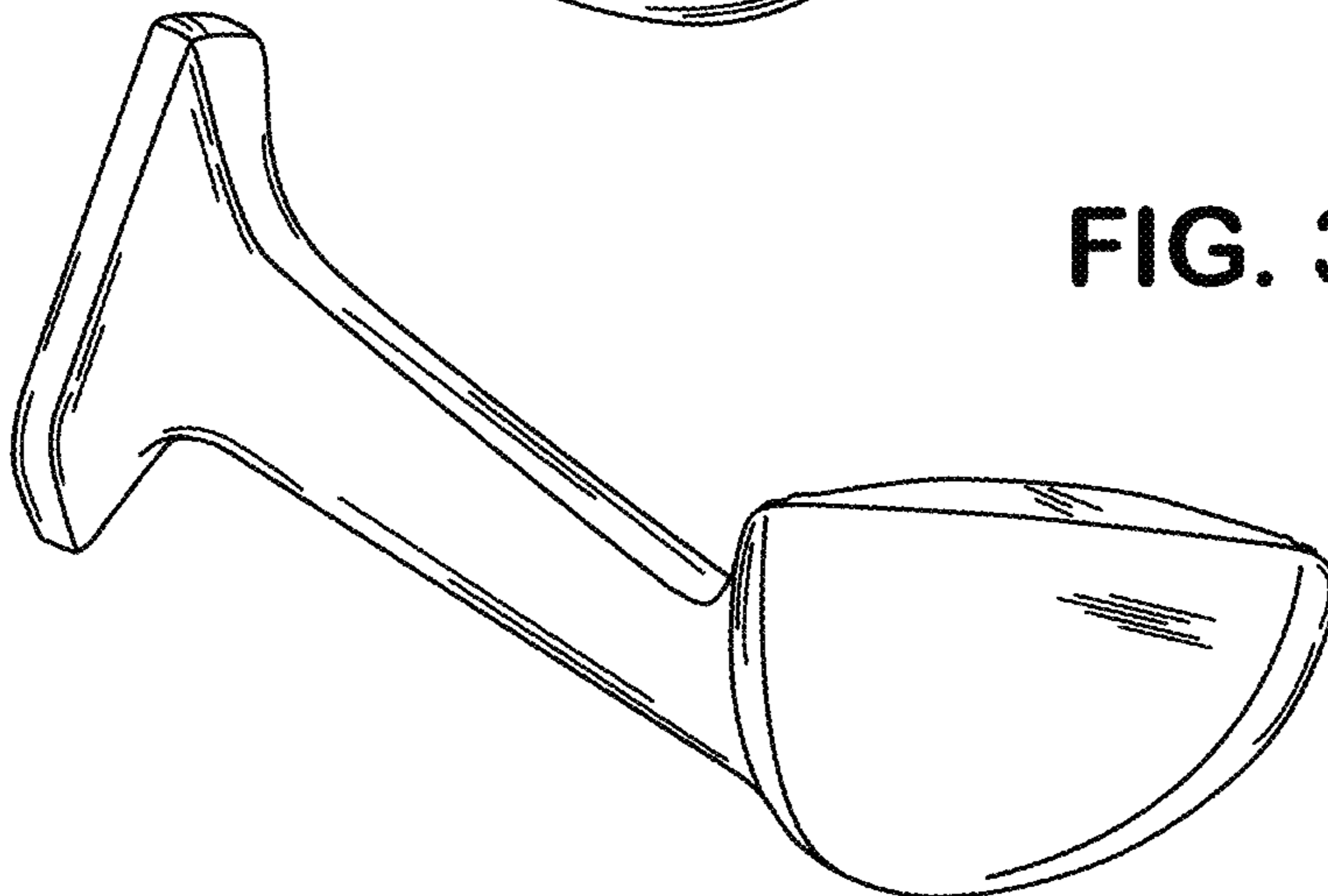

FIG. 3



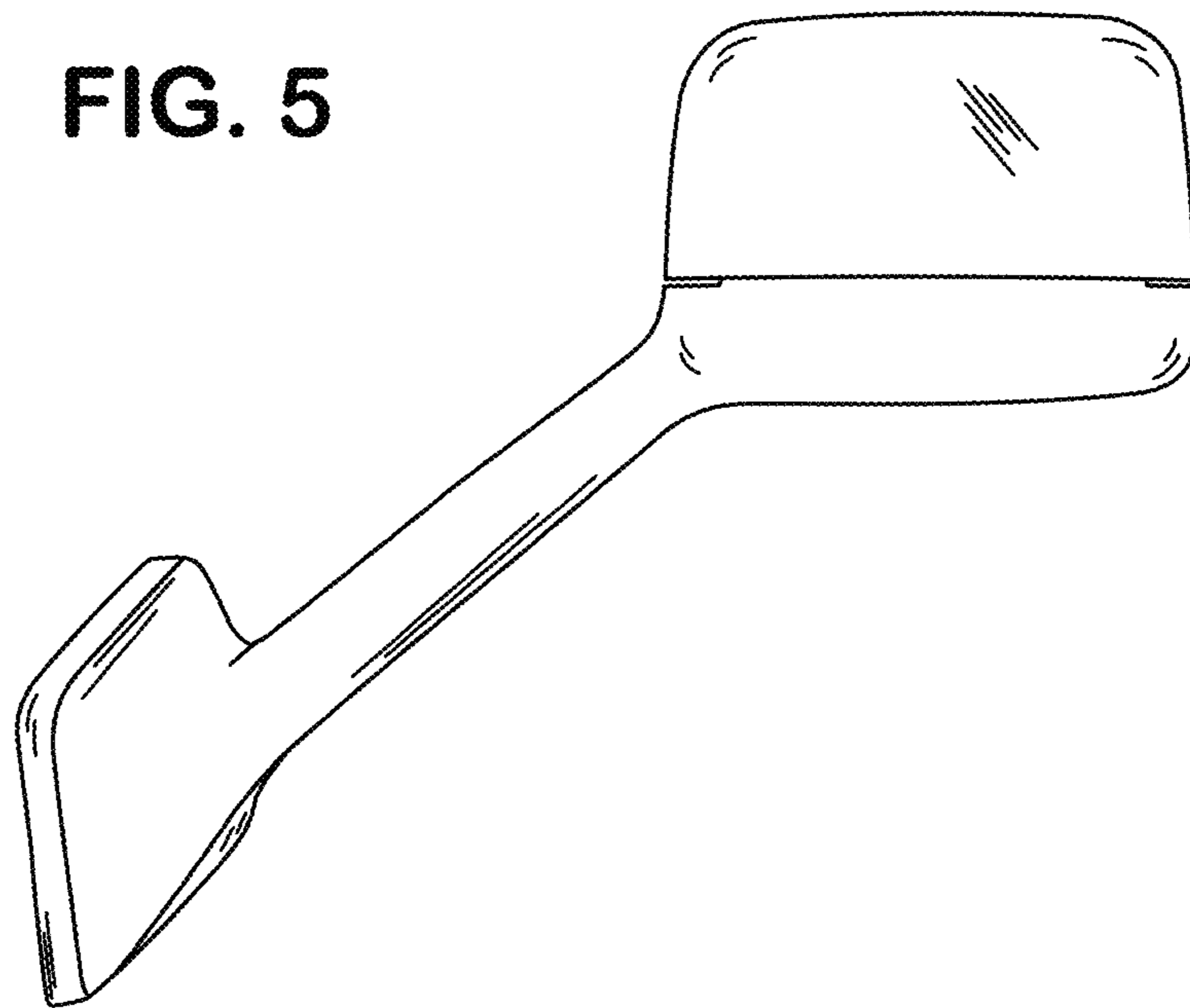
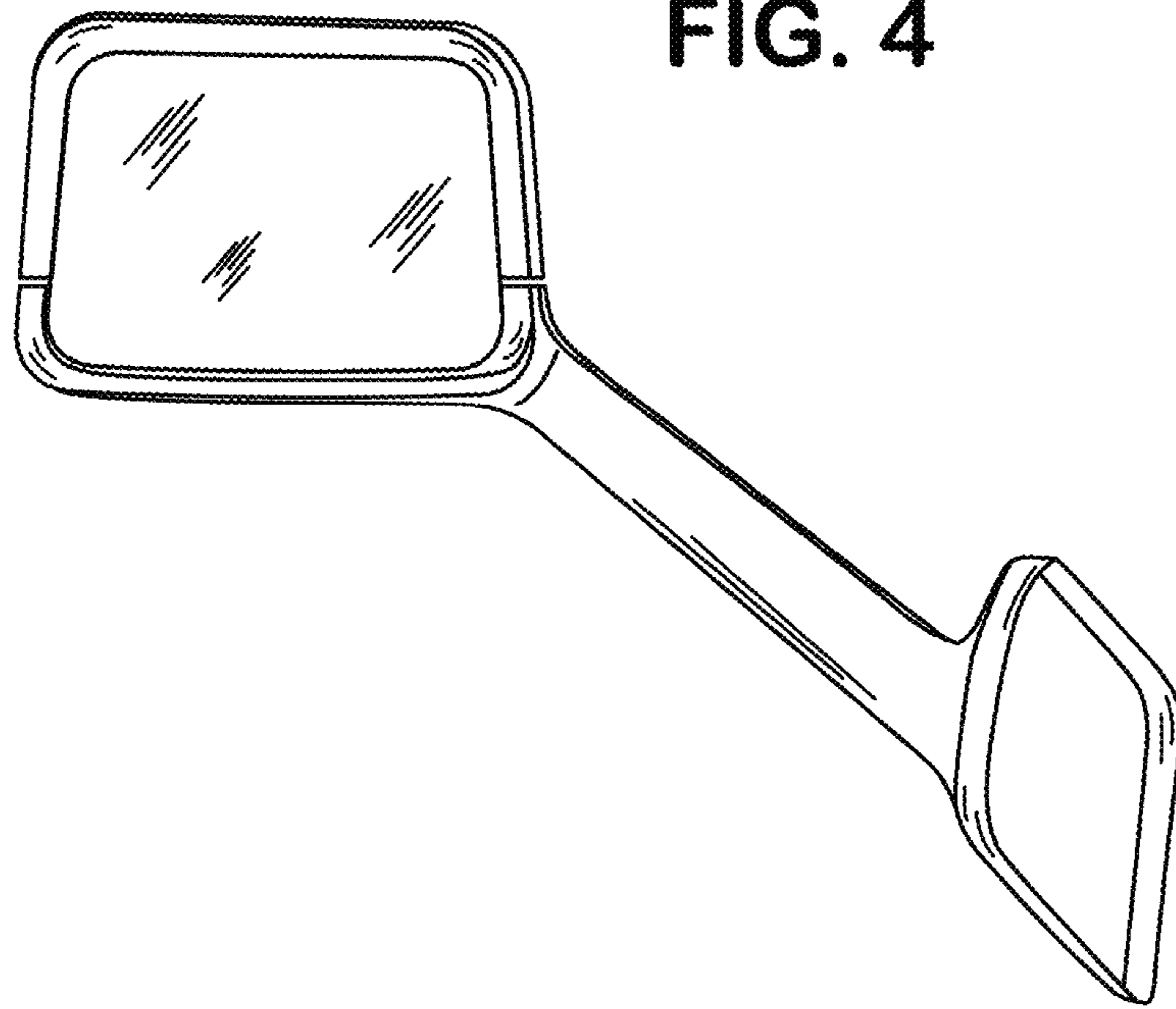

FIG. 6

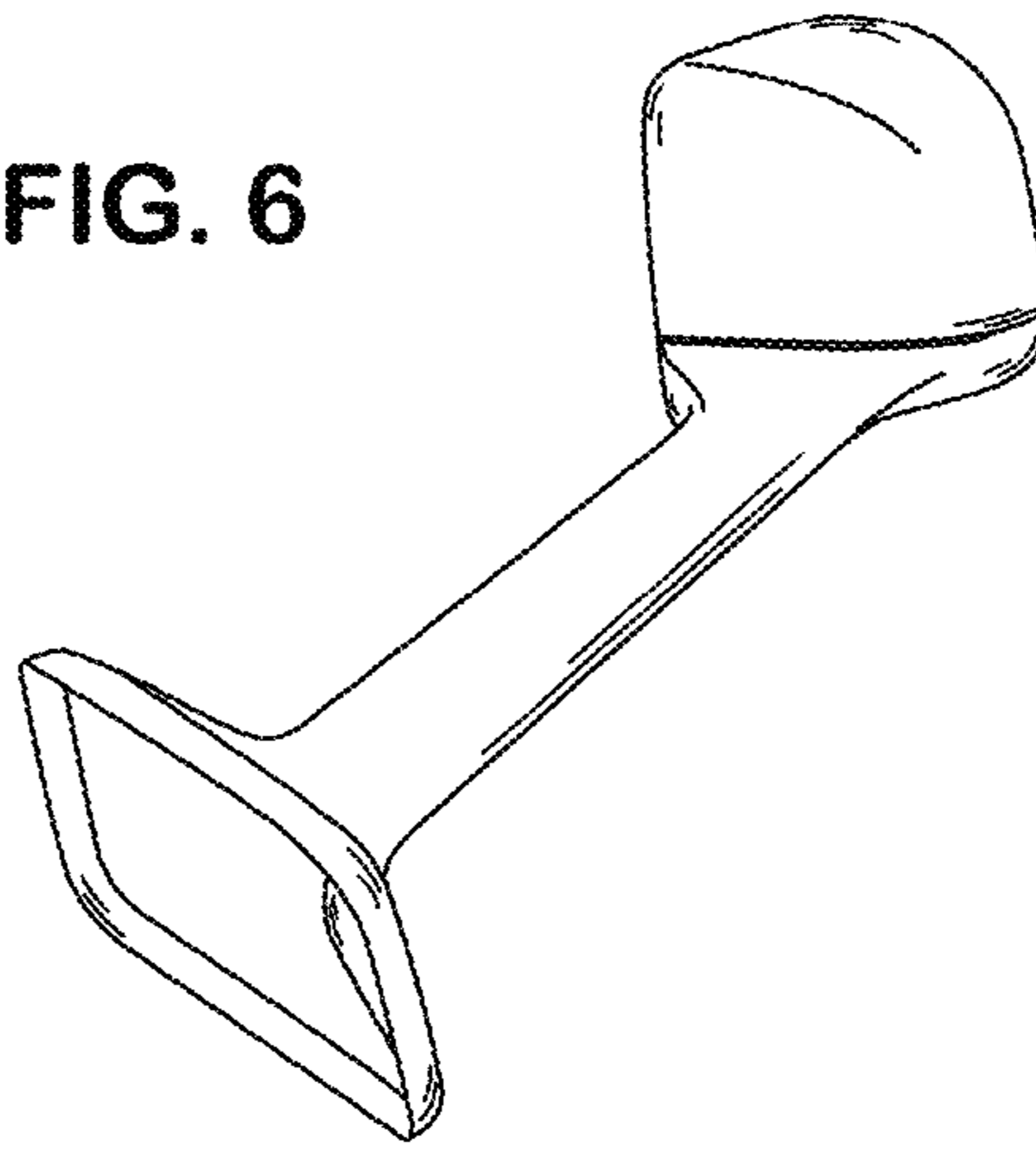

FIG. 7

