



US00D791596S

(12) **United States Design Patent** (10) **Patent No.:** **US D791,596 S**
Chivot et al. (45) **Date of Patent:** **** Jul. 11, 2017**

(54) **BOTTLE**

(71) Applicant: **PepsiCo, Inc.**, Purchase, NY (US)

(72) Inventors: **Emmanuel Chivot**, Poissy (FR); **Andy Jordan**, London (GB); **Philip Nigel Bordet-Stead**, London (GB); **Laurent Robin-Prevallee**, London (GB)

(73) Assignee: **PepsiCo, Inc.**, Purchase, NY (US)

(**) Term: **15 Years**

(21) Appl. No.: **29/537,061**

(22) Filed: **Aug. 21, 2015**

Related U.S. Application Data

(60) Continuation of application No. 29/514,565, filed on Jan. 14, 2015, now Pat. No. Des. 739,745, which is a division of application No. 29/470,786, filed on Oct. 24, 2013, now Pat. No. Des. 722,878.

(51) **LOC (10) Cl.** **09-01**

(52) **U.S. Cl.**
USPC **D9/516; D9/538; D9/552; D9/554**

(58) **Field of Classification Search**

USPC D9/516, 530, 537-540, 541, 549, 552, D9/554, 558-559, 567, 571, 600, 636, D9/640, 643-645, 648, 655, 657-661, D9/667, 500, 502-503, 542-543, 715, D9/719; 215/379, 381-382; 220/660, 220/669, 675
CPC B65D 1/00; B65D 1/02; B65D 1/0223; B65D 1/40; B65D 1/42; B65D 23/00; B65D 2501/00; B65D 2501/0009; B65D 81/00

See application file for complete search history.

(56) **References Cited**

U.S. PATENT DOCUMENTS

D183,310 S	8/1958	Hack	
D207,799 S	5/1967	Roberts	
D213,290 S	2/1969	Fuerst	
D286,984 S	12/1986	Durand	
D465,727 S	11/2002	Duranthon	
D478,278 S	8/2003	Masotta et al.	
D524,165 S	7/2006	Scott	
D571,213 S	6/2008	Le Bras-Brown et al.	
D575,154 S	8/2008	Andrews et al.	
D637,908 S	5/2011	Fleischhacker et al.	
D651,905 S	1/2012	Bartolomei	
D664,852 S	8/2012	Weber-Trinkfass et al.	
D703,056 S	4/2014	Yourist	
D722,877 S	2/2015	Chivot et al.	
D722,878 S	2/2015	Chivot et al.	
D722,881 S	2/2015	Chivot et al.	
D727,157 S	4/2015	Finlay et al.	
D738,729 S *	9/2015	Chivot	D9/516
D738,735 S *	9/2015	Chivot	D9/538

(Continued)

Primary Examiner — Dana L Meyrow

(74) *Attorney, Agent, or Firm* — Sterne, Kessler, Goldstein & Fox P.L.L.C.

(57) **CLAIM**

The ornamental design for a bottle, as shown and described.

DESCRIPTION

FIG. 1 is a top, front, right side perspective view of a bottle showing the claimed design;
FIG. 2 is a front view thereof;
FIG. 3 is a right side view thereof;
FIG. 4 is a rear view thereof;
FIG. 5 is a left side view thereof;
FIG. 6 is a top view thereof; and,
FIG. 7 is a bottom view thereof.
The dashed broken lines in the figures show portions of the bottle that form no part of the claimed design. The dot-dash broken lines in the figures show boundaries that form no part of the claimed design.

1 Claim, 4 Drawing Sheets

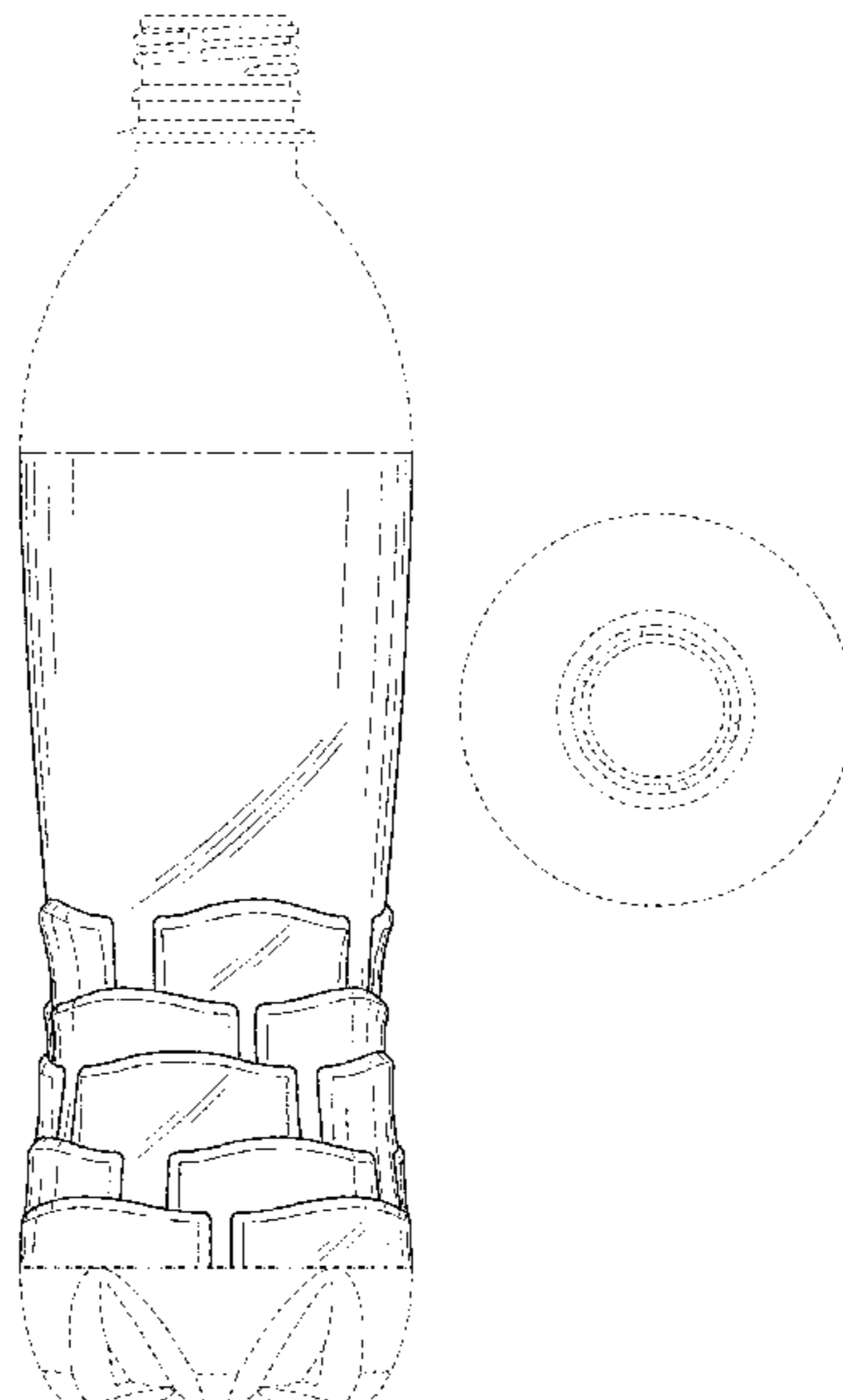

(56)

References Cited

U.S. PATENT DOCUMENTS

D739,745 S * 9/2015 Chivot D9/516
2011/0226788 A1 9/2011 Yourist

* cited by examiner

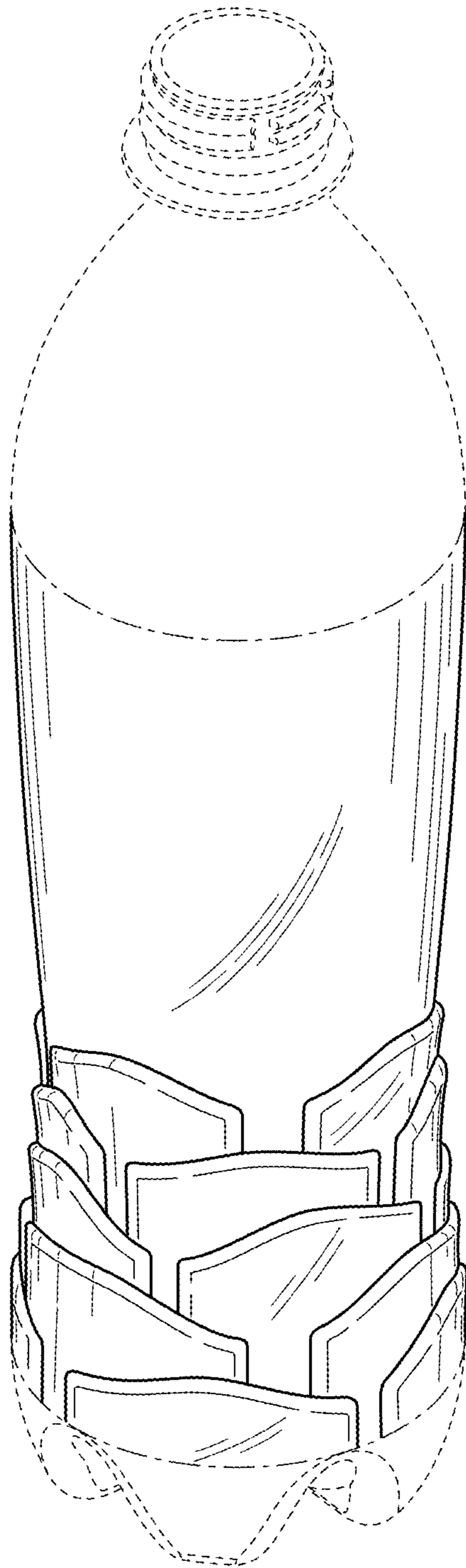

FIG. 1

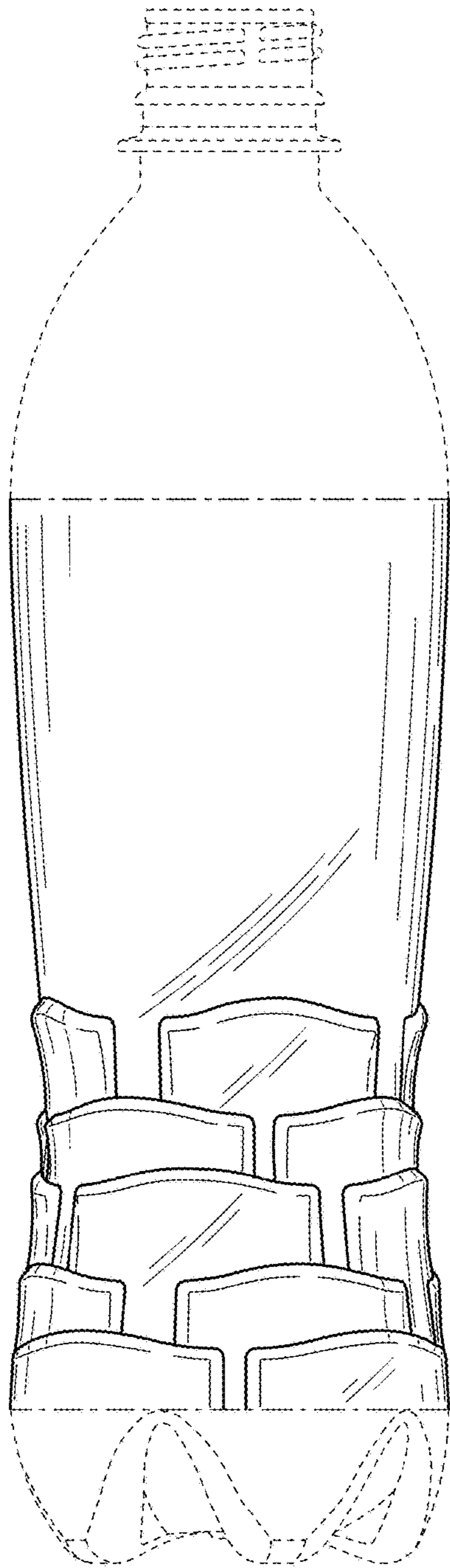

FIG. 2

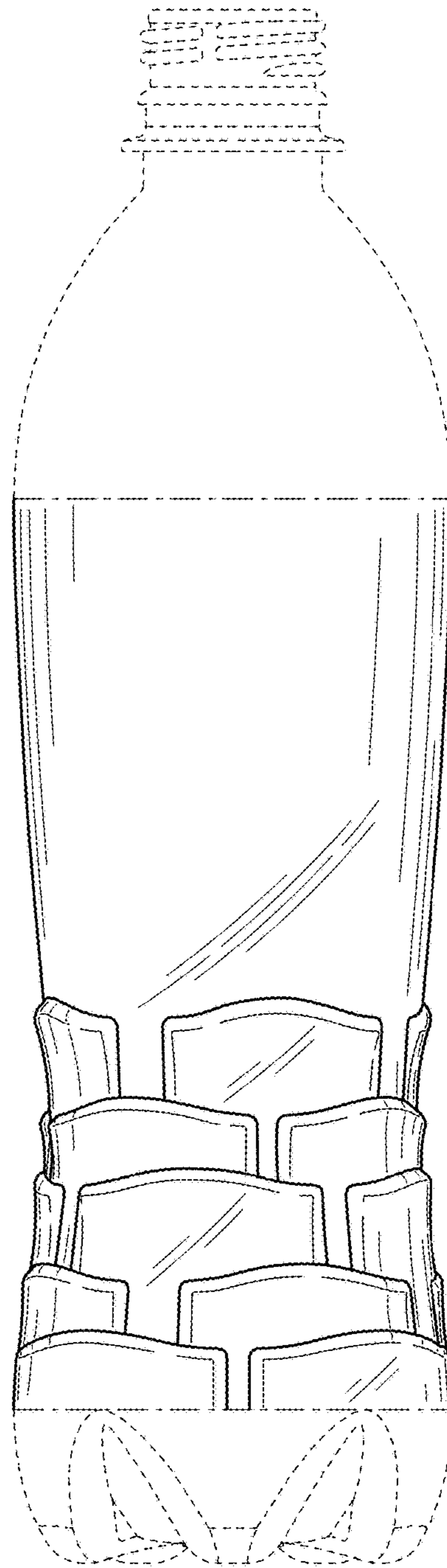

FIG. 3

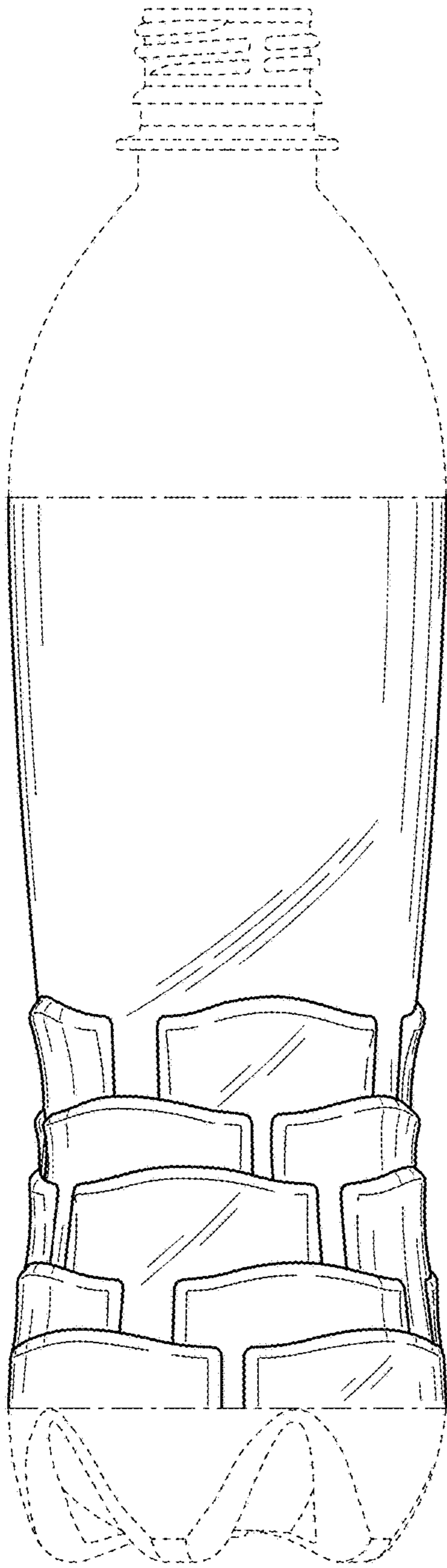

FIG. 4

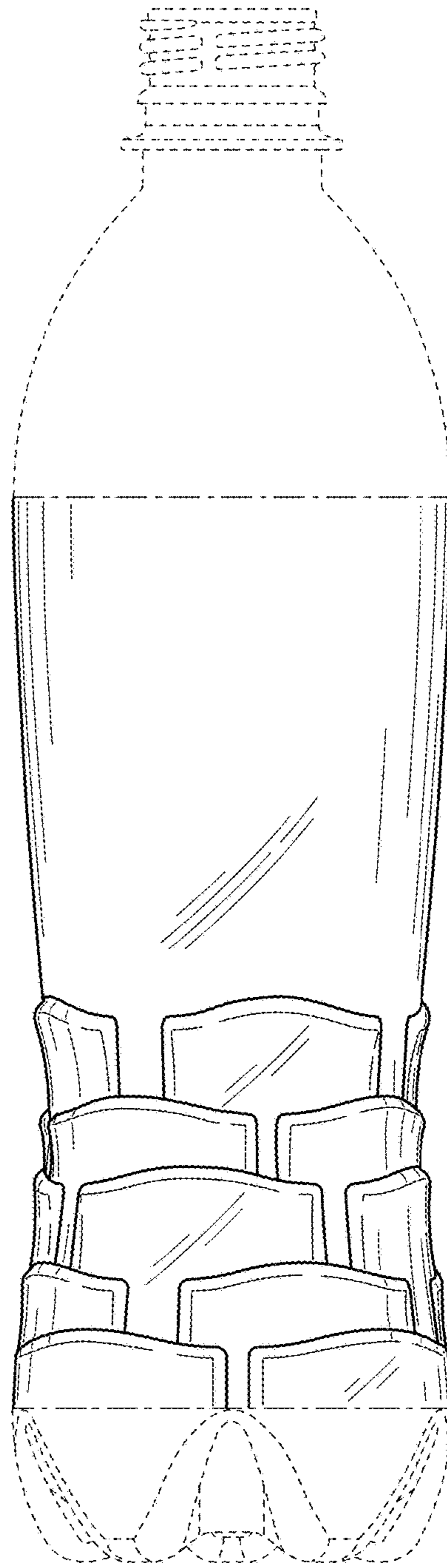

FIG. 5

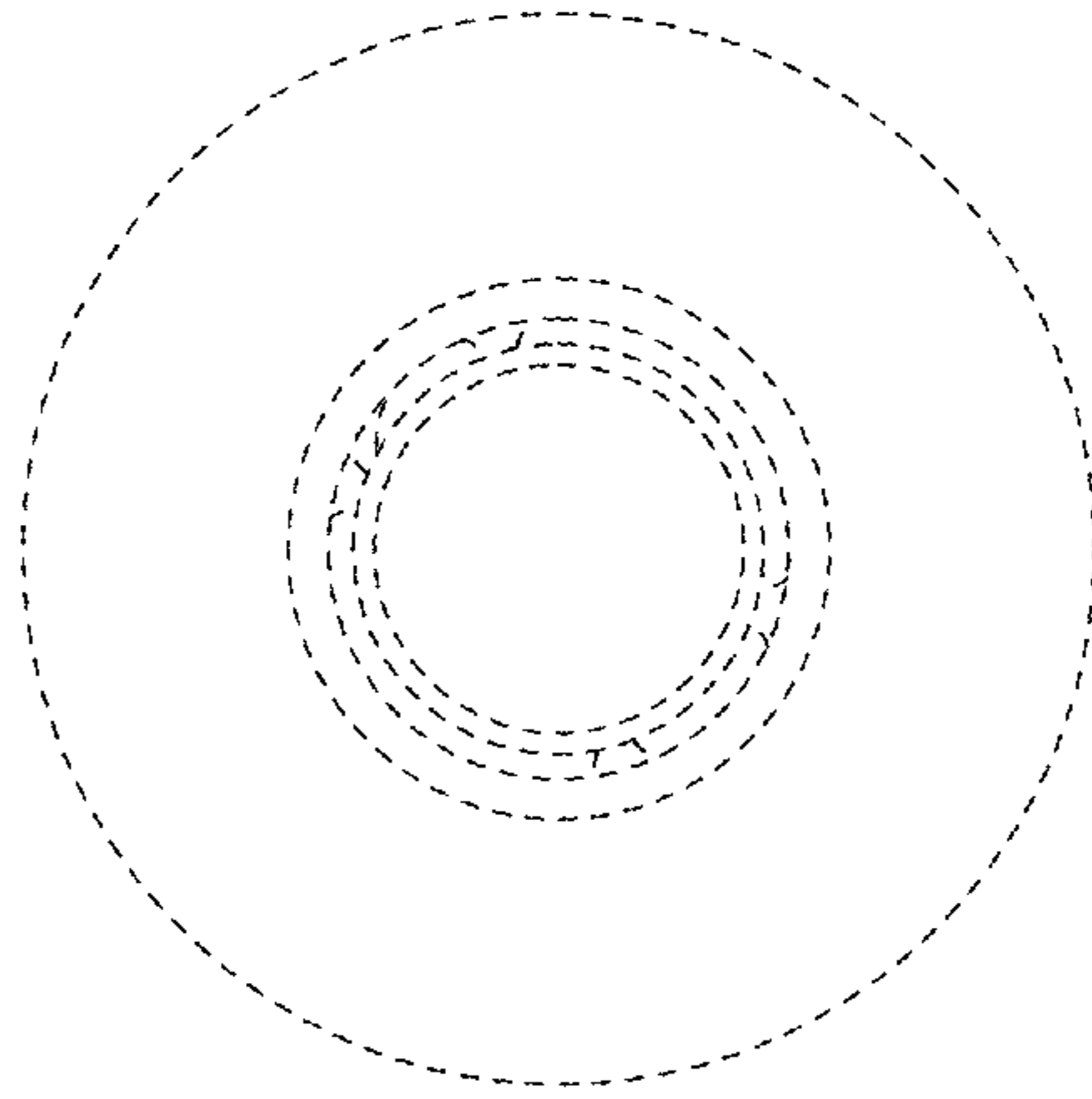

FIG. 6

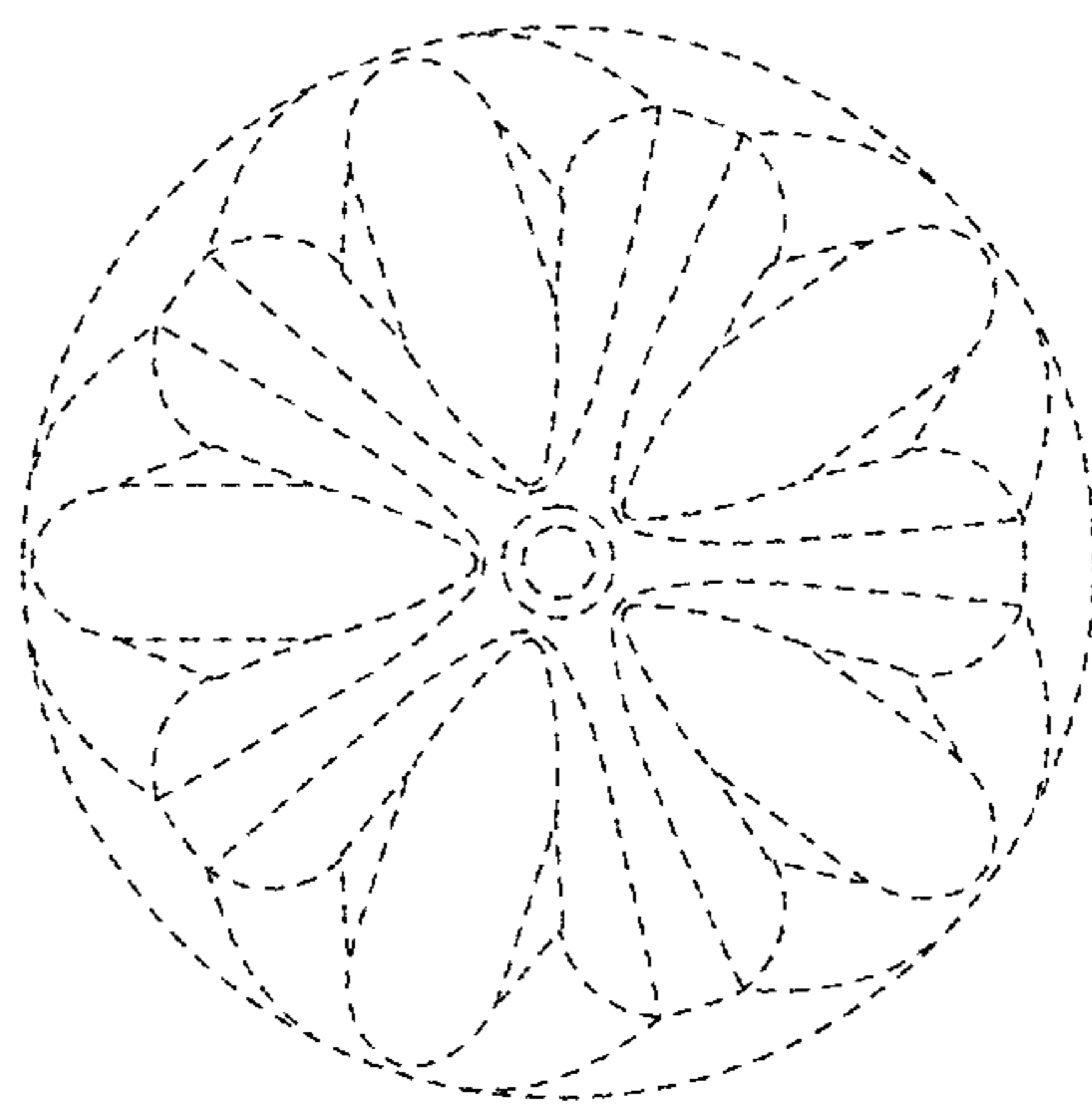

FIG. 7