



US00D791561S

(12) **United States Design Patent**
Takasaki et al.

(10) **Patent No.:** **US D791,561 S**

(45) **Date of Patent:** **** Jul. 11, 2017**

(54) **PINCHING TOOL**

(71) Applicant: **ENGINEER INC.**, Osaka-shi, Osaka (JP)

(72) Inventors: **Mitsuhiro Takasaki**, Osaka (JP);
Shinnosuke Kawai, Osaka (JP);
Masanori Ando, Osaka (JP); **Mayu Fukuda**, Osaka (JP)

(73) Assignee: **ENGINEER INC.**, Osaka-shi, Osaka (JP)

(**) Term: **15 Years**

(21) Appl. No.: **29/533,105**

(22) Filed: **Jul. 14, 2015**

Related U.S. Application Data

(63) Continuation of application No. 14/656,956, filed on Mar. 13, 2015.

(51) **LOC (10) Cl.** **08-05**

(52) **U.S. Cl.**
USPC **D8/52**

(58) **Field of Classification Search**
USPC D8/4, 5, 51-60

(Continued)

(56) **References Cited**

U.S. PATENT DOCUMENTS

1,413,690 A * 4/1922 Slocum A22C 11/00
188/65.4

2,668,538 A 2/1954 Baker
(Continued)

FOREIGN PATENT DOCUMENTS

JP S30-7692 B 10/1955
JP S50-148198 U 12/1975
JP S58-188165 U 12/1983

Primary Examiner — Deanna L Pratt

(74) *Attorney, Agent, or Firm* — Muncy, Geissler, Olds & Lowe, P.C.

(57) **CLAIM**

The ornamental design for a pinching tool, as shown and described.

DESCRIPTION

FIG. 1 is a right side view of pinching tool with respect to first embodiment.

FIG. 2 is a left side view thereof.

FIG. 3 is a front view thereof.

FIG. 4 is a rear view thereof.

FIG. 5 is a plan view thereof.

FIG. 6 is a bottom view thereof.

FIG. 7 is an enlarged view of the area indicated in FIG. 1.

FIG. 8 is an enlarged plan view of the area of the pinching tool indicated in FIG. 9.

FIG. 9 is a perspective view of the pinching tool of which jaws are in an open state.

FIG. 10 is a right side view of pinching tool with respect to second embodiment.

FIG. 11 is a left side view thereof.

FIG. 12 is a front view thereof.

FIG. 13 is a rear view thereof.

FIG. 14 is a plan view thereof.

FIG. 15 is a bottom view thereof.

FIG. 16 is an enlarged view of the area indicated in FIG. 10.

FIG. 17 is an enlarged plan view of the area of the pinching tool indicated in FIG. 18; and,

FIG. 18 is a perspective view of the pinching tool of which jaws are in an open state.

The broken lines showing in the above figures are for the purpose of illustrating environmental structure and form no part of the claimed designs.

1 Claim, 6 Drawing Sheets

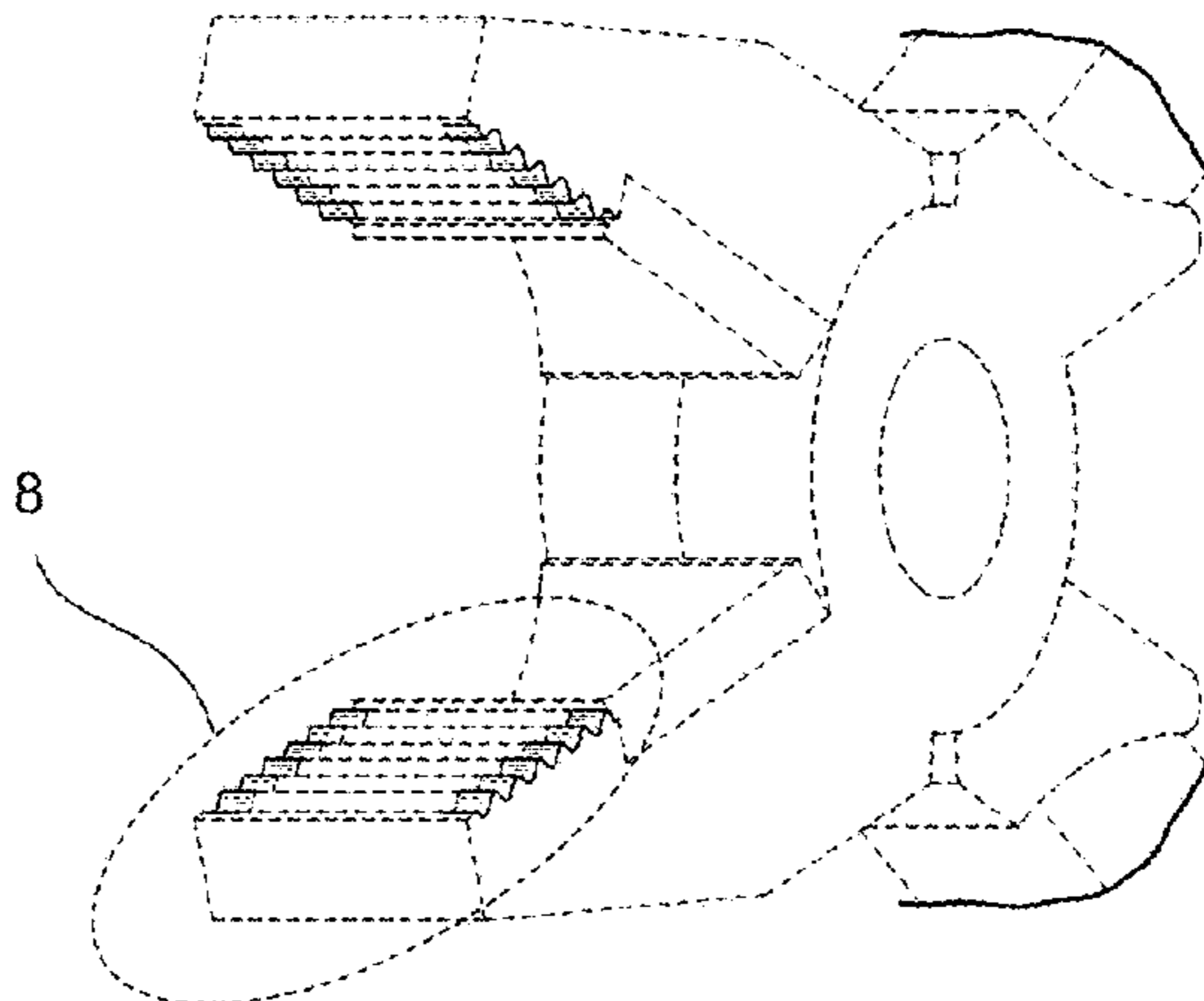
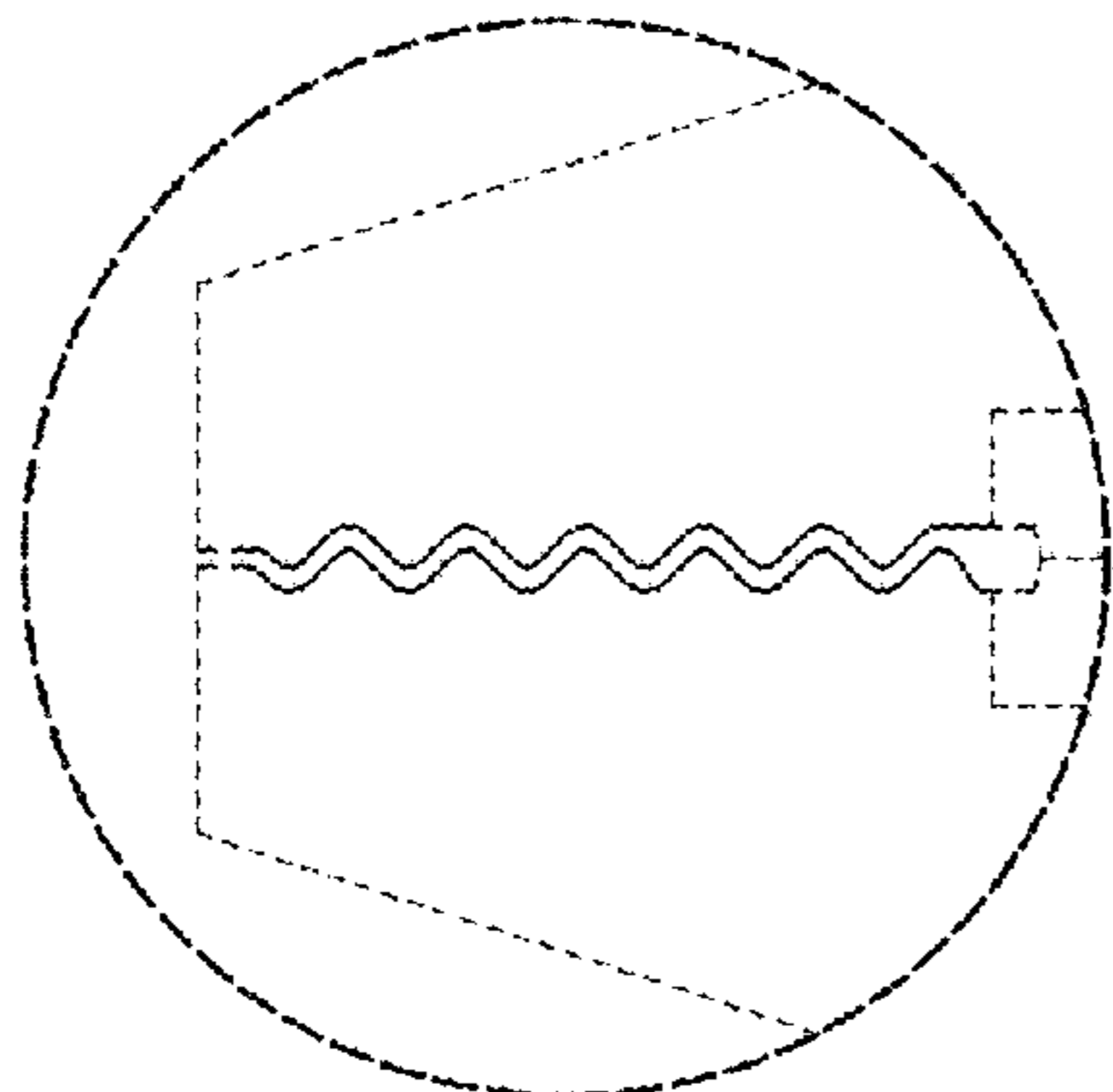

US D791,561 S

Page 2

(58) **Field of Classification Search**
CPC B25B 7/00; B25B 7/02; B25B 7/10; B25B
7/12; B25B 7/22; B25B 7/123
See application file for complete search history.

(56) **References Cited**

U.S. PATENT DOCUMENTS

2,725,774 A * 12/1955 Tekse B23D 21/08
30/102
3,447,172 A * 6/1969 Clark B25F 1/003
30/90.4
3,694,834 A 10/1972 Daniels, Jr.
3,808,870 A * 5/1974 Blancett B21D 15/02
140/106
D261,096 S * 10/1981 Petersen D8/22
4,297,756 A * 11/1981 Lance B25B 7/00
7/127
5,351,585 A * 10/1994 Leseberg B25B 7/123
81/370
5,385,072 A * 1/1995 Neff B25B 7/04
81/356
5,604,947 A 2/1997 Bates et al.
6,012,363 A * 1/2000 Minkin B25B 7/00
294/119
D419,841 S * 2/2000 Wrigley D8/52
D424,387 S * 5/2000 Neff D8/22
D428,317 S * 7/2000 Lin D8/52
D437,756 S * 2/2001 Lin D8/52

6,199,458 B1 * 3/2001 Wrigley B25B 7/123
81/319
D447,027 S * 8/2001 Lin D8/52
6,279,433 B1 * 8/2001 Chervenak B25B 7/00
81/177.2
D449,208 S * 10/2001 Ping D8/52
D451,776 S * 12/2001 Ping D8/52
6,324,712 B1 * 12/2001 Elsener, Sr. B23D 29/023
30/254
D458,821 S * 6/2002 Peperkorn D8/52
D458,822 S * 6/2002 Peperkorn D8/52
6,408,724 B1 * 6/2002 Whiteford B25B 7/123
81/367
D470,373 S * 2/2003 Ferreria D8/52
D494,825 S * 8/2004 Hernandez D8/105
D499,320 S * 12/2004 Seber D8/52
6,923,097 B2 8/2005 Takasaki
7,124,786 B1 * 10/2006 Gowhari H01R 43/033
140/117
D599,637 S * 9/2009 Valencia D8/52
D604,580 S * 11/2009 Robinson D8/52
D635,427 S * 4/2011 Chervenak D8/52
D635,428 S * 4/2011 Lucus D8/52
D651,060 S * 12/2011 Chervenak D8/52
D653,092 S * 1/2012 Carra D8/52
8,656,812 B2 2/2014 Kawai et al.
D763,048 S * 8/2016 Murphy D8/52
2016/0184980 A1 * 6/2016 Takasaki B25B 7/02
7/133

* cited by examiner

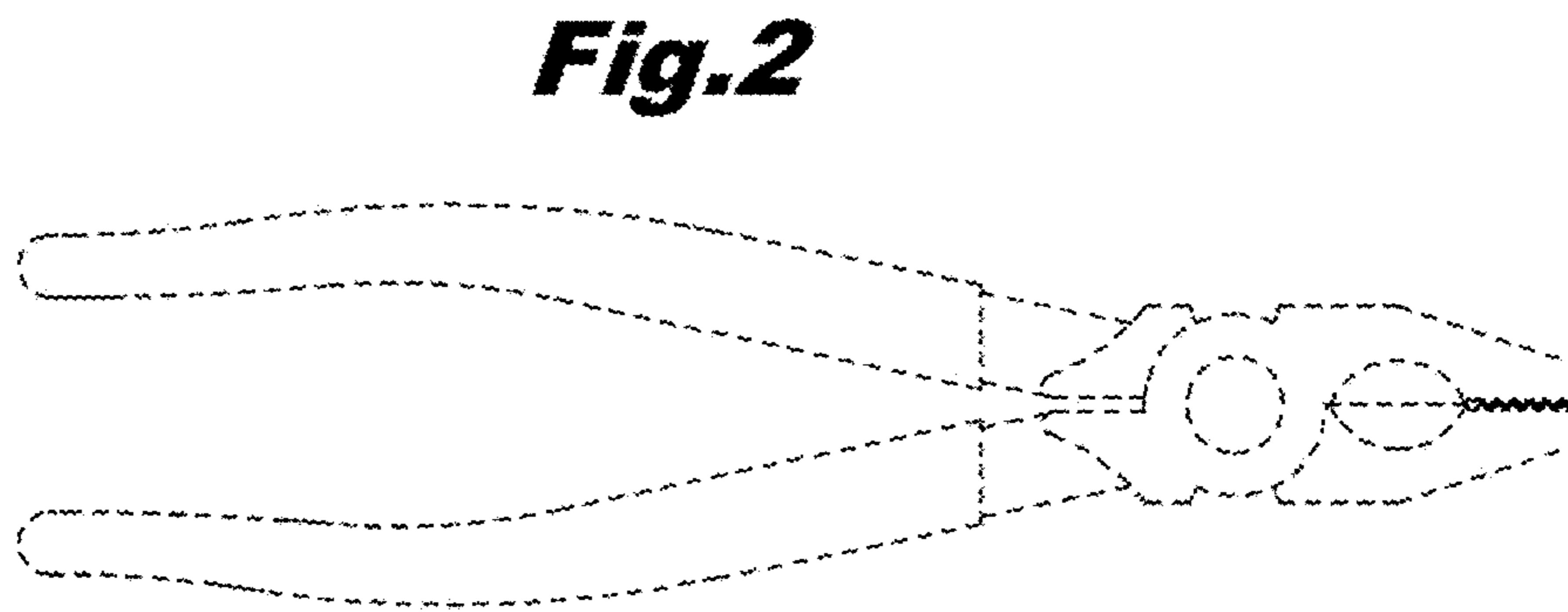
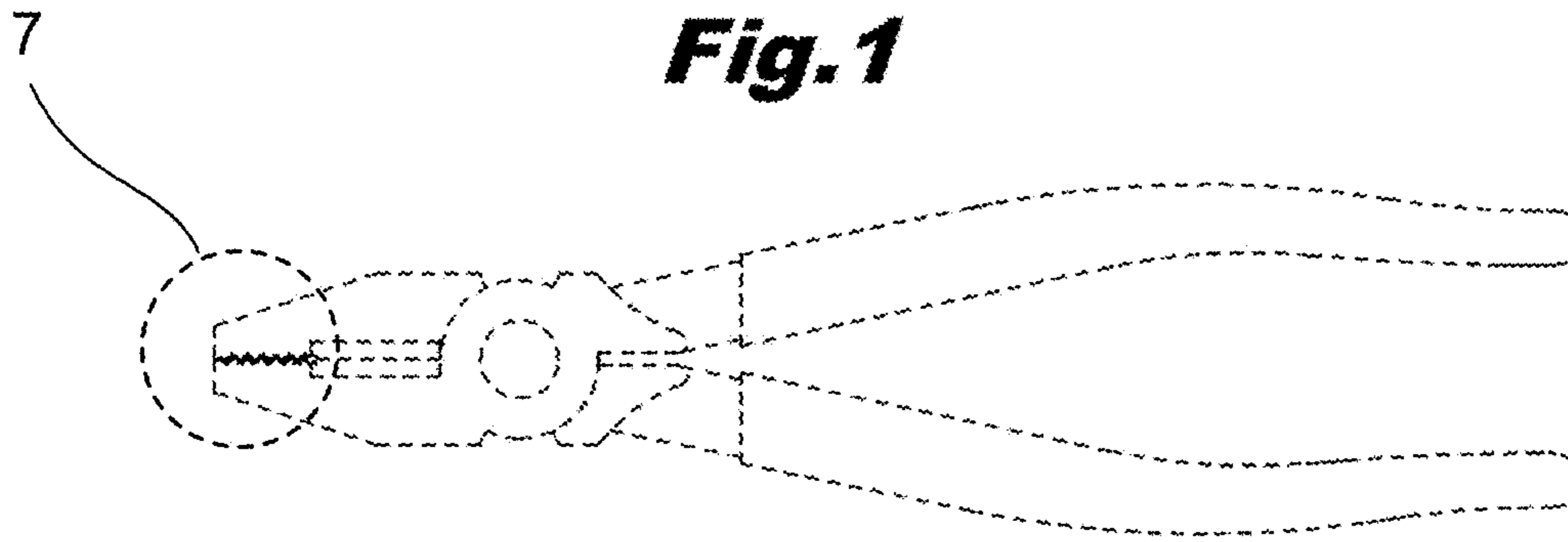

Fig.3

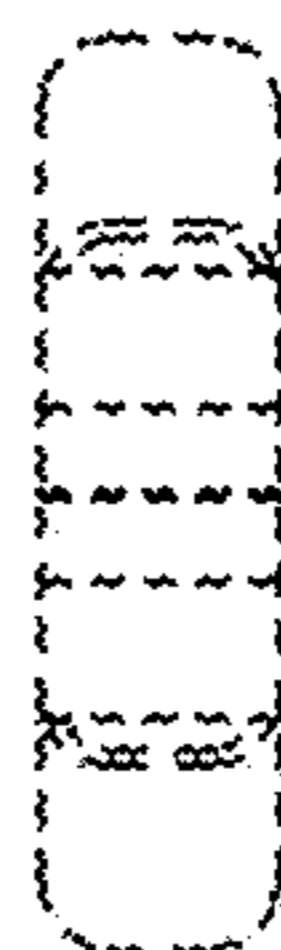

Fig.4



Fig.5

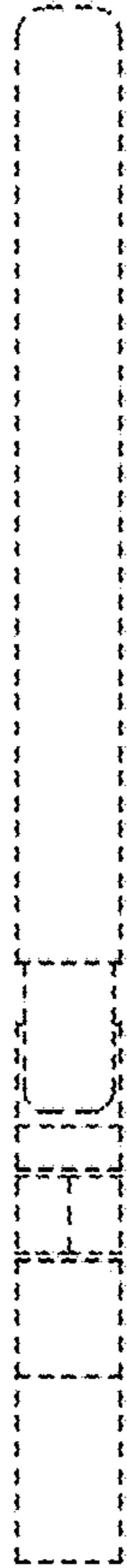

Fig.6

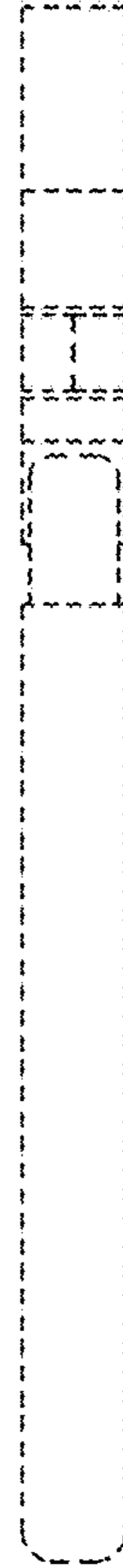

Fig.7

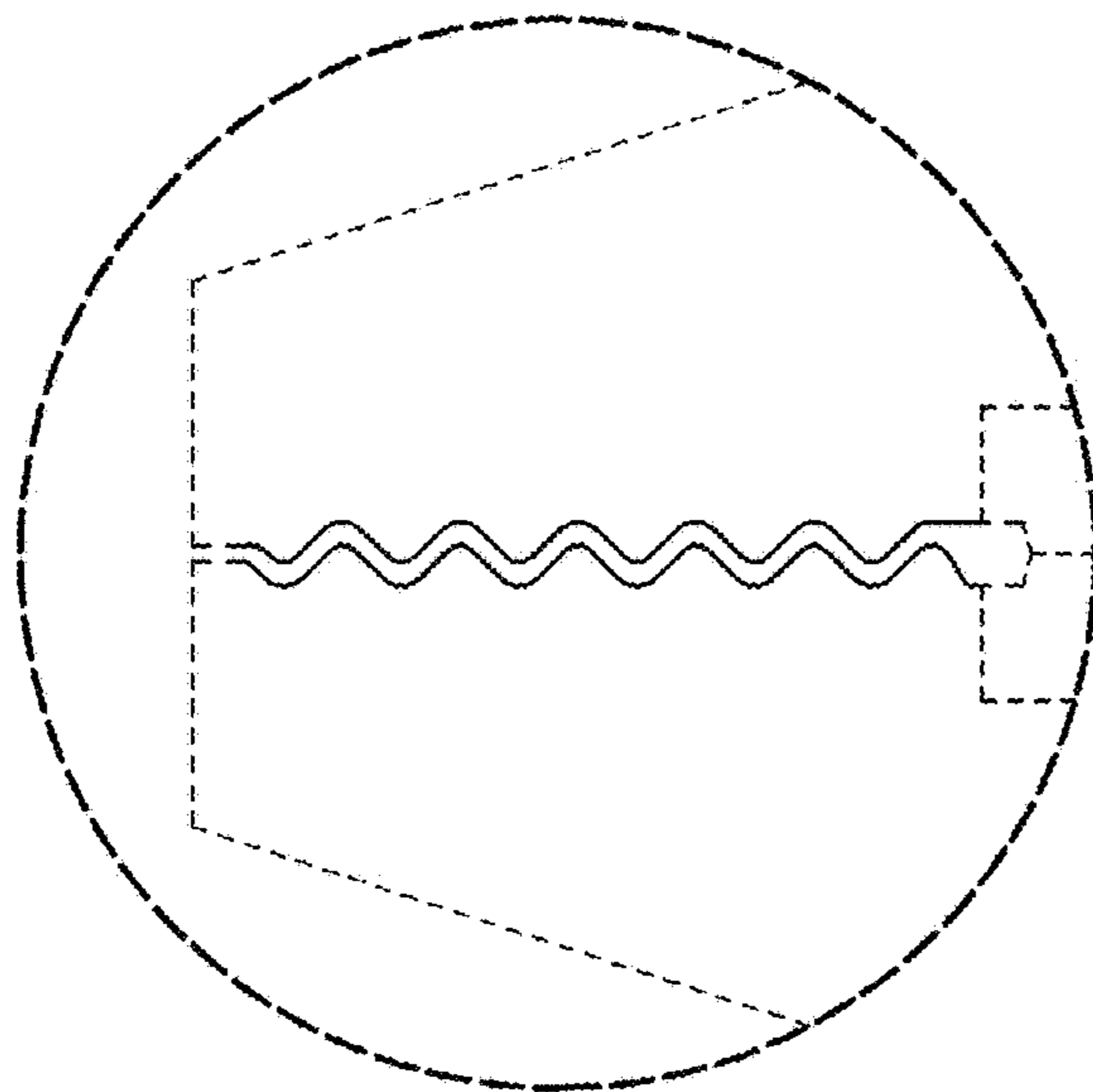

Fig. 8

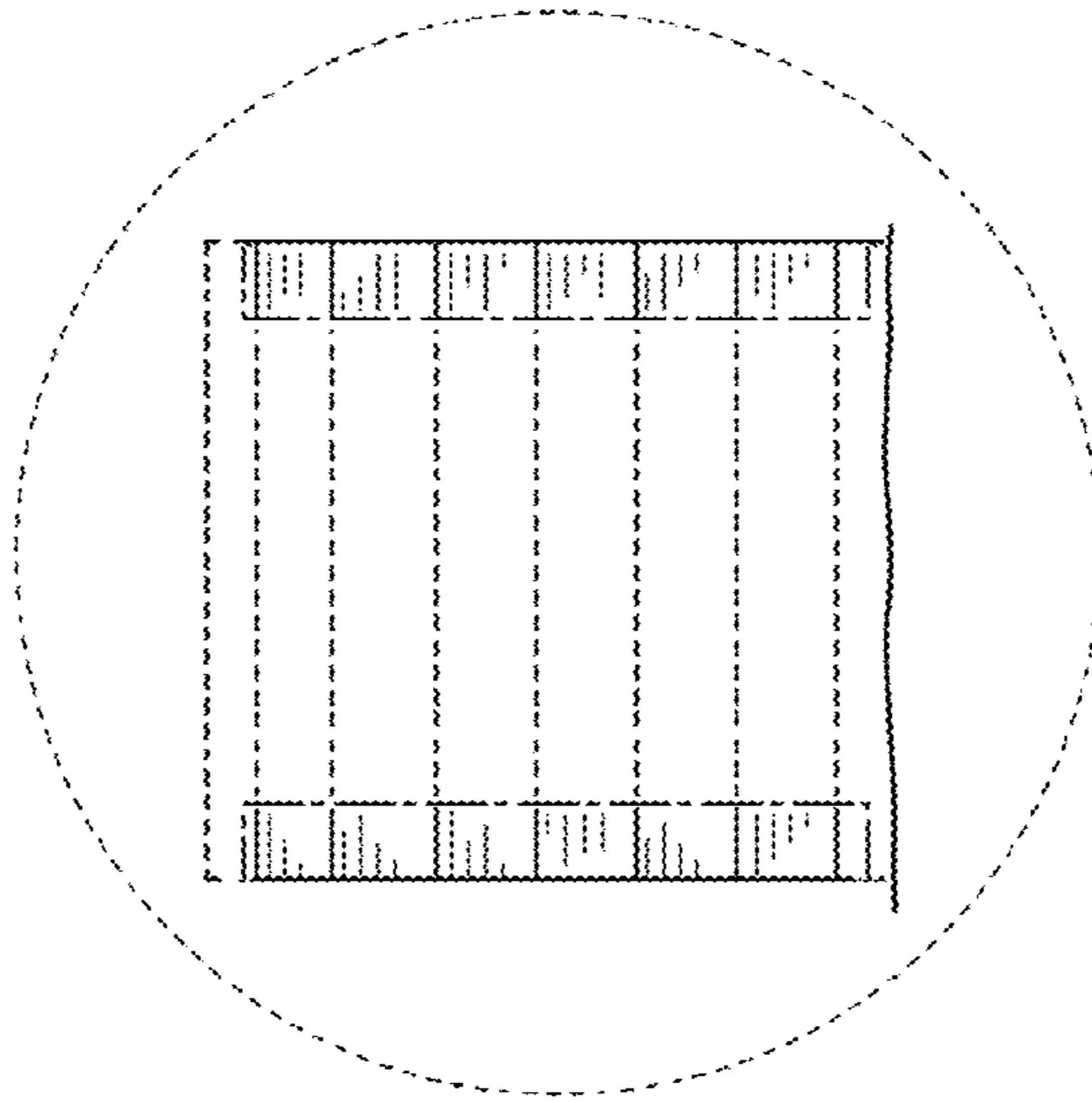

Fig. 9

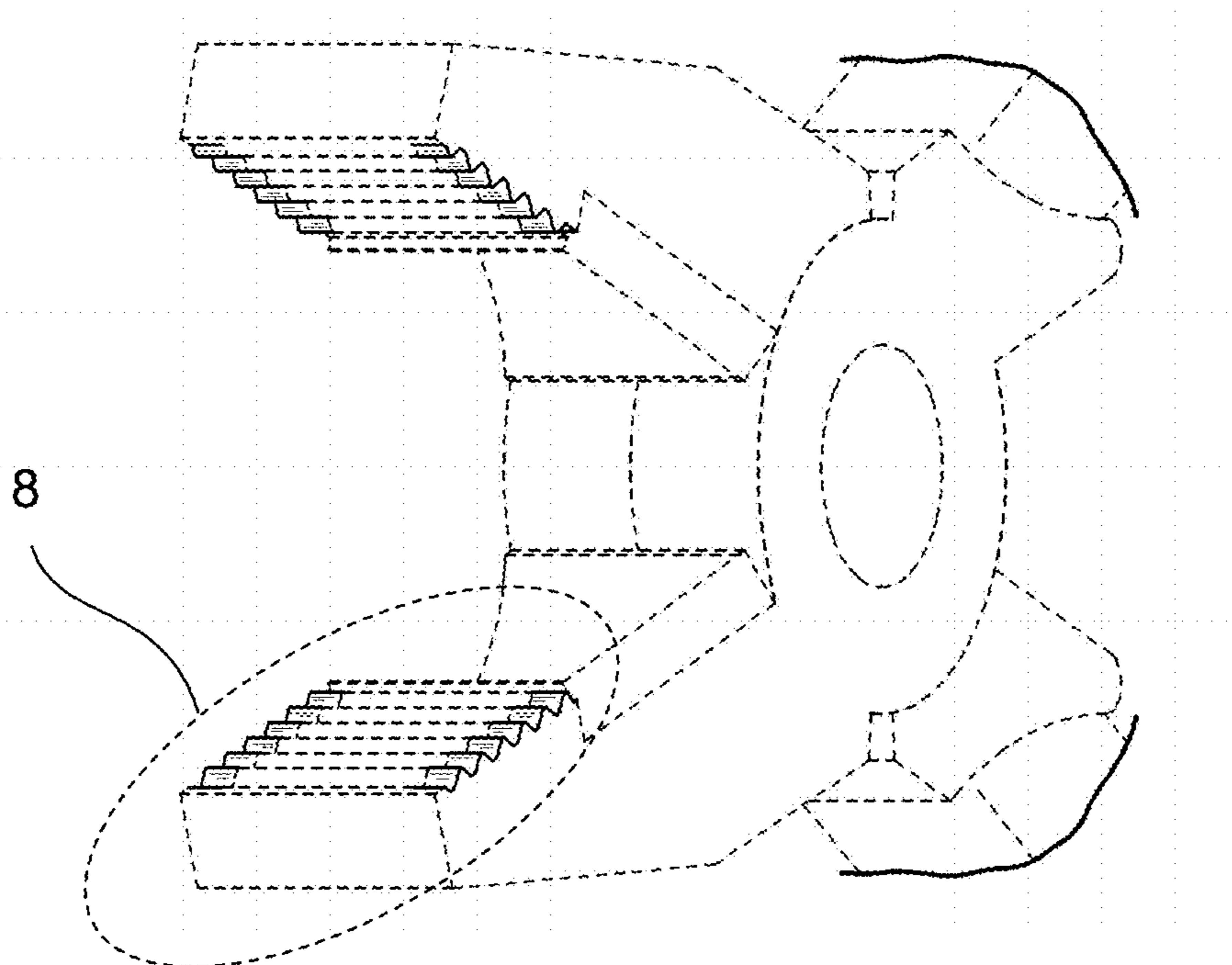

Fig.10

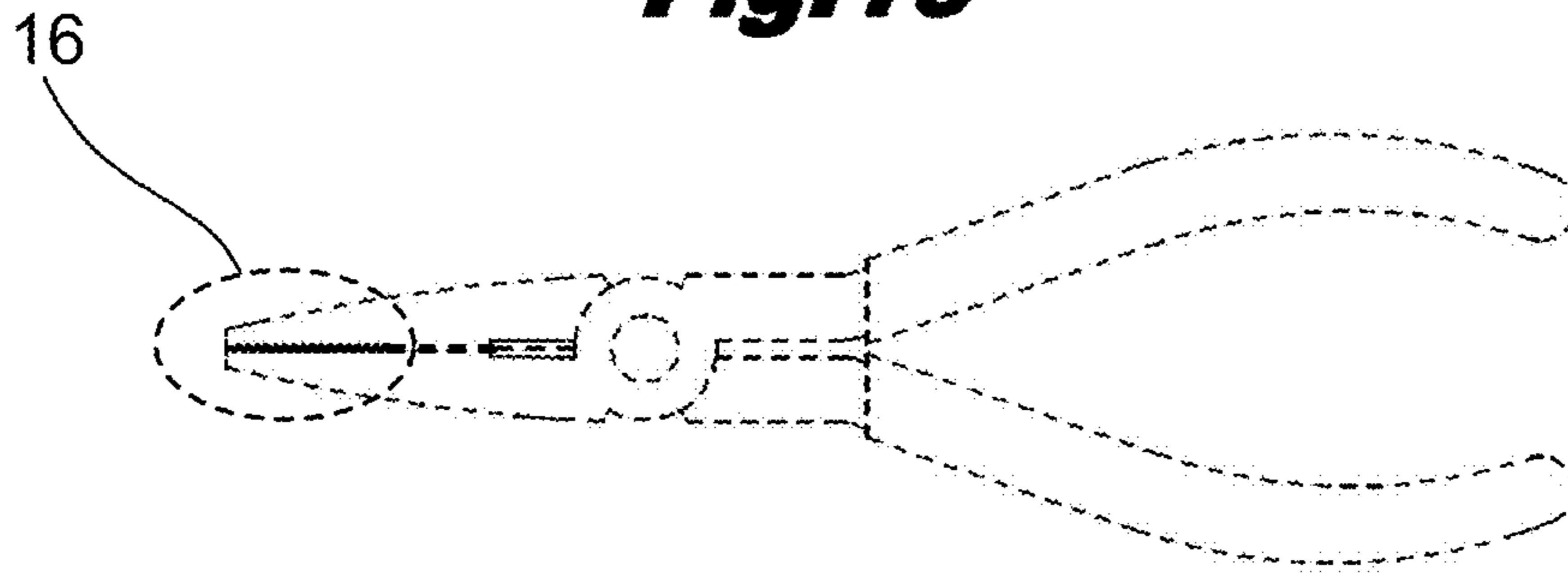

Fig.11

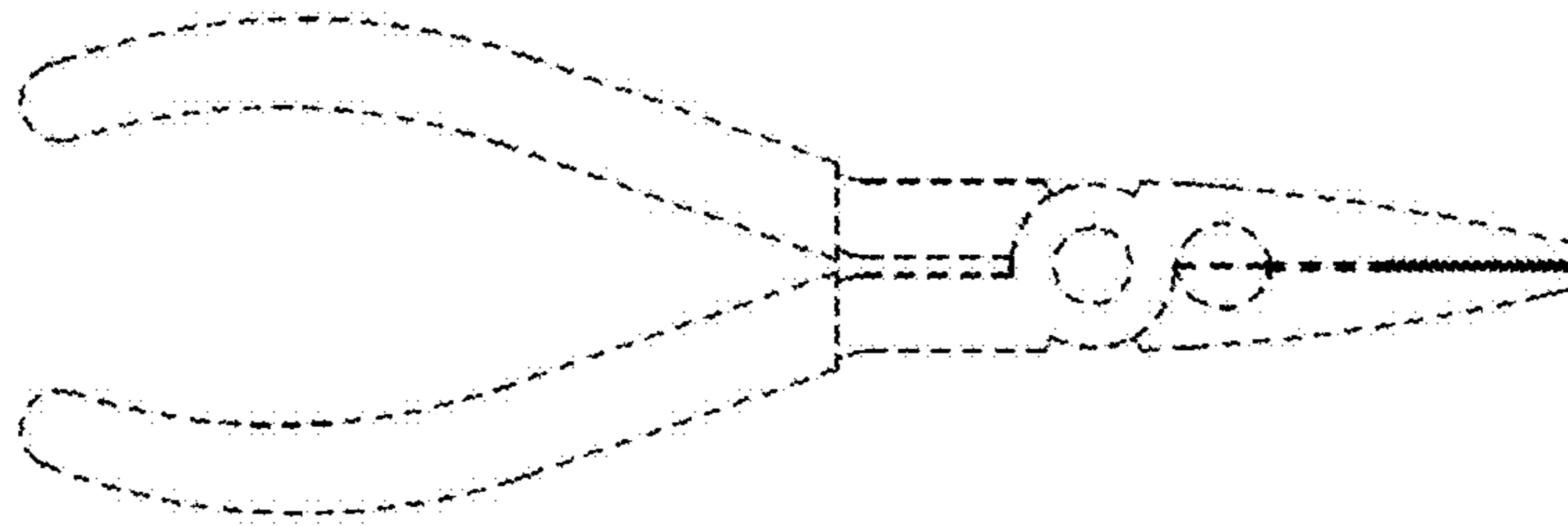

Fig.12



Fig.13

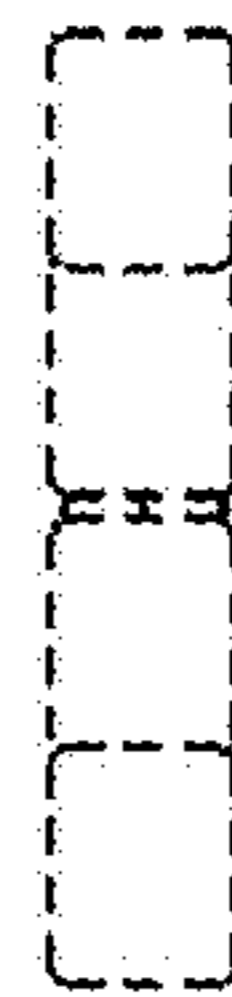

Fig.14



Fig.15



Fig.16

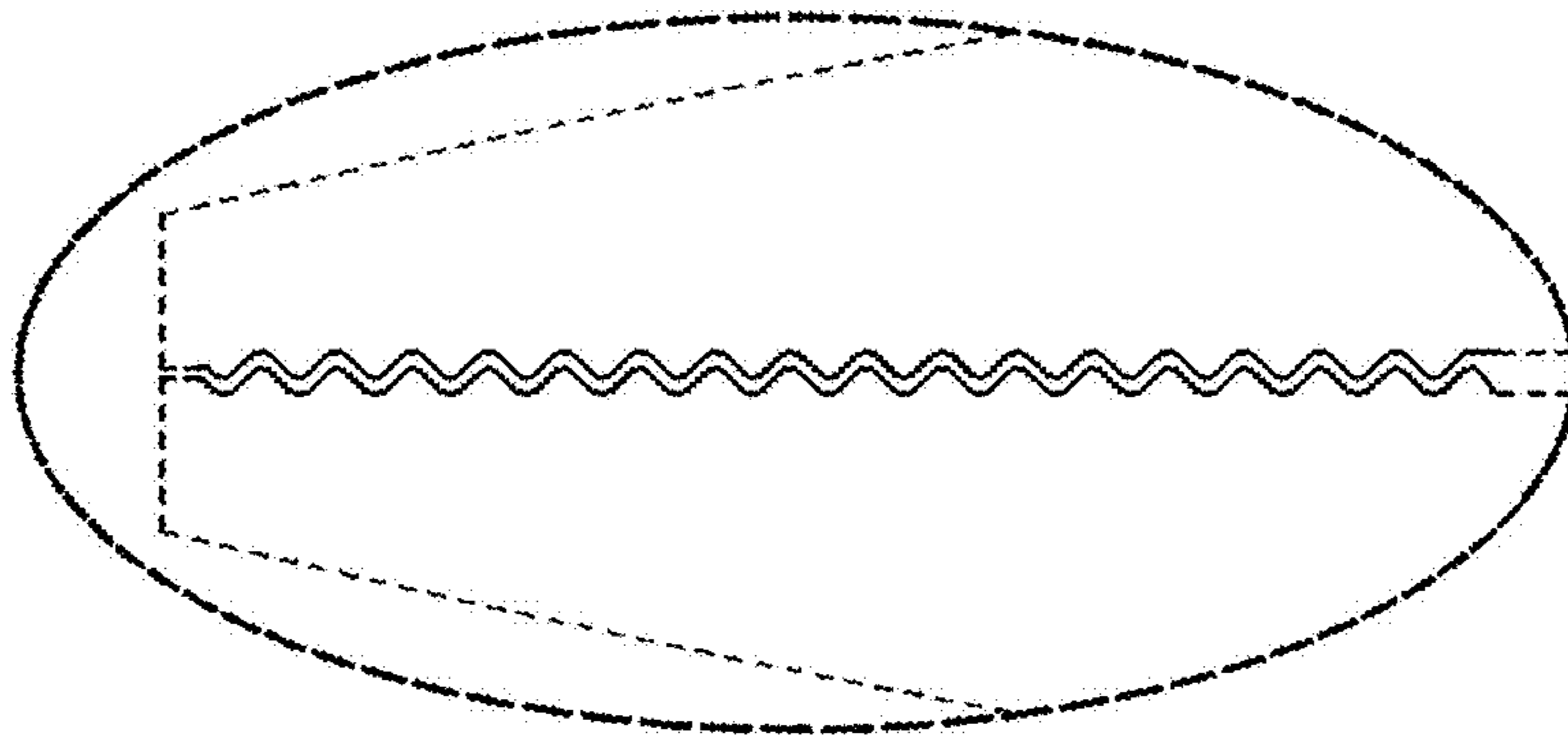

Fig.17

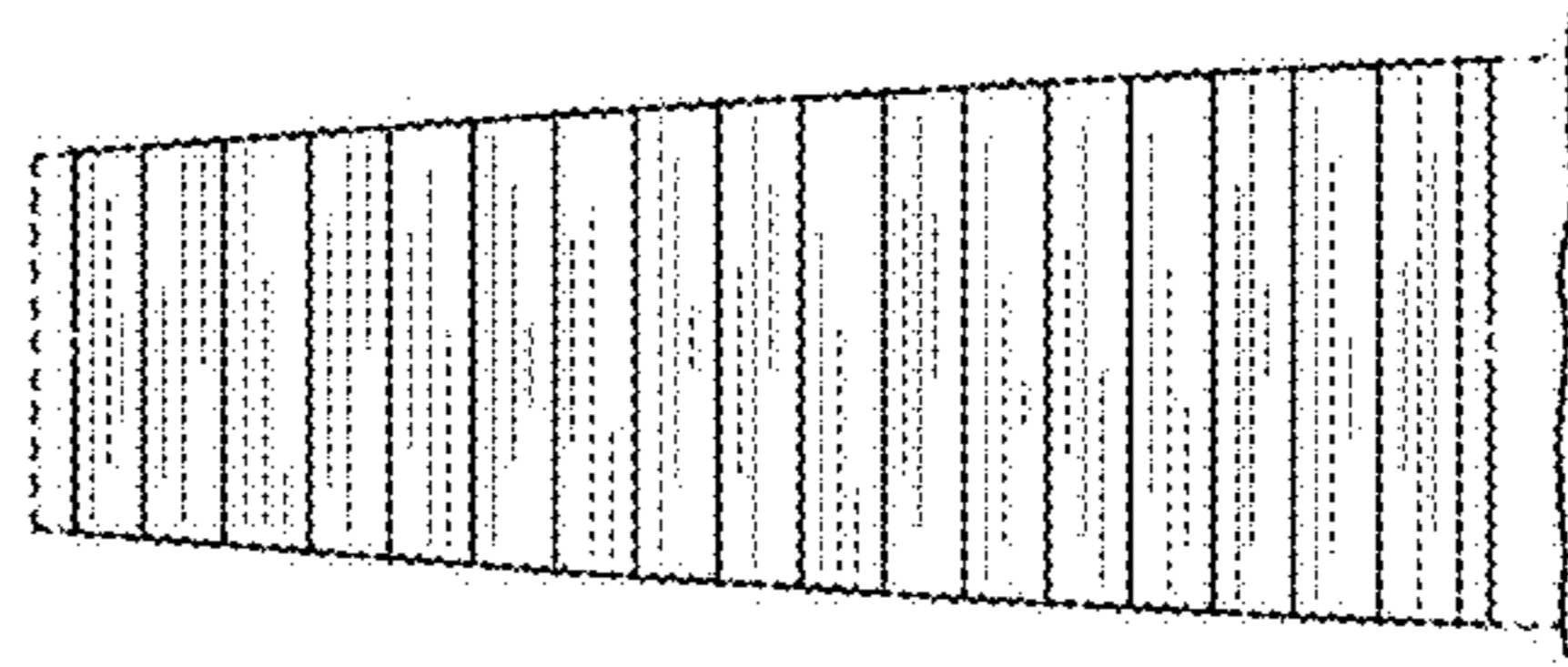

Fig.18

