



US00D791536S

(12) **United States Design Patent** (10) **Patent No.:** **US D791,536 S**  
**Rose** (45) **Date of Patent:** **\*\* Jul. 11, 2017**

(54) **UTENSIL HANDLE**

(71) Applicant: **Williams-Sonoma, Inc.**, San Francisco, CA (US)

(72) Inventor: **Phillip John Patrick Rose**, San Francisco, CA (US)

(73) Assignee: **Williams-Sonoma, Inc.**, San Francisco, CA (US)

(\*\*) Term: **15 Years**

(21) Appl. No.: **29/559,596**

(22) Filed: **Mar. 30, 2016**

(51) **LOC (10) Cl.** ..... **07-03**

(52) **U.S. Cl.**  
USPC ..... **D7/401.2**

(58) **Field of Classification Search**  
USPC ..... D7/393-395, 401.2, 642-652, 693, D7/695-696; D8/10, 93, 97-100, 107, D8/300, 321; D22/117-118  
CPC ..... A01B 1/20; A01B 1/22; A22C 25/006; A47G 21/06; A47G 21/065; A61B 17/3211; A61B 17/3213; B21D 53/64; B25G 3/36; B26B 1/00; B26B 1/08; B26B 1/10; B26B 3/00; B26B 3/02; B26B 3/03; B26B 3/04; B26B 3/06; B26B 5/00; B26B 5/001; B26B 5/007; B26B 7/00; B26B 7/005; B26B 9/00; B26B 9/02; B26B 11/00; B26B 11/006; B26B 17/00; B26B 17/006; B26B 29/02  
See application file for complete search history.

(56) **References Cited**

U.S. PATENT DOCUMENTS

D149,677 S *	5/1948	Roblin .....	D7/395
D169,413 S *	4/1953	Bordelon .....	30/340
D170,293 S *	8/1953	Wallance .....	30/346
D246,281 S *	11/1977	Ferrara, Jr. ....	D7/649
D276,018 S *	10/1984	Hagedorn .....	D7/637
D418,026 S *	12/1999	Joergensen .....	D7/649
D435,407 S *	12/2000	Yager .....	D8/10
D461,689 S *	8/2002	Lothe .....	D7/649
D498,120 S *	11/2004	Deglon .....	D7/649
D502,054 S *	2/2005	Deglon .....	D7/401.2
D557,980 S *	12/2007	de Bretton Gordon .....	D7/401.2
D611,780 S *	3/2010	Laib .....	D7/695
D751,862 S *	3/2016	deBretton Gordon .....	D7/401.2

\* cited by examiner

*Primary Examiner* — Ricky Pham

(74) *Attorney, Agent, or Firm* — Cook Alex Ltd.; R. Blake Johnston

(57) **CLAIM**

The ornamental design for a utensil handle, as shown and described.

**DESCRIPTION**

FIG. 1 is a perspective view of the utensil handle; FIG. 2 is a left side elevational view of the utensil handle, the opposite side of which is a mirror image; FIG. 3 is a rear elevational view of the utensil handle; FIG. 4 is a front elevational view of the utensil handle; FIG. 5 is a top plan view of the utensil handle; and, FIG. 6 is a bottom plan view of the utensil handle. The broken lines shown in the drawings are for illustrative purposes only and form no part of the claimed design.

**1 Claim, 3 Drawing Sheets**

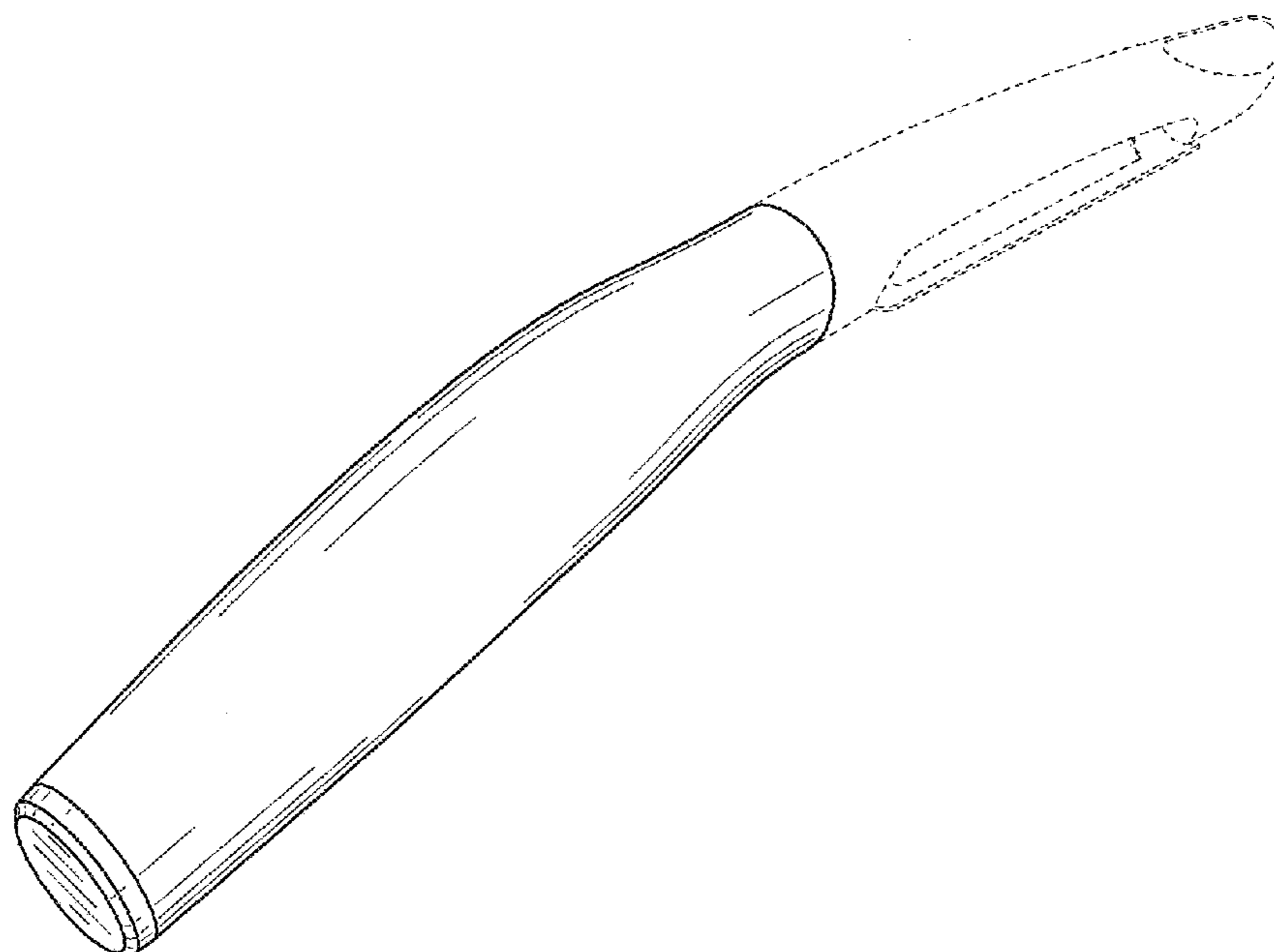

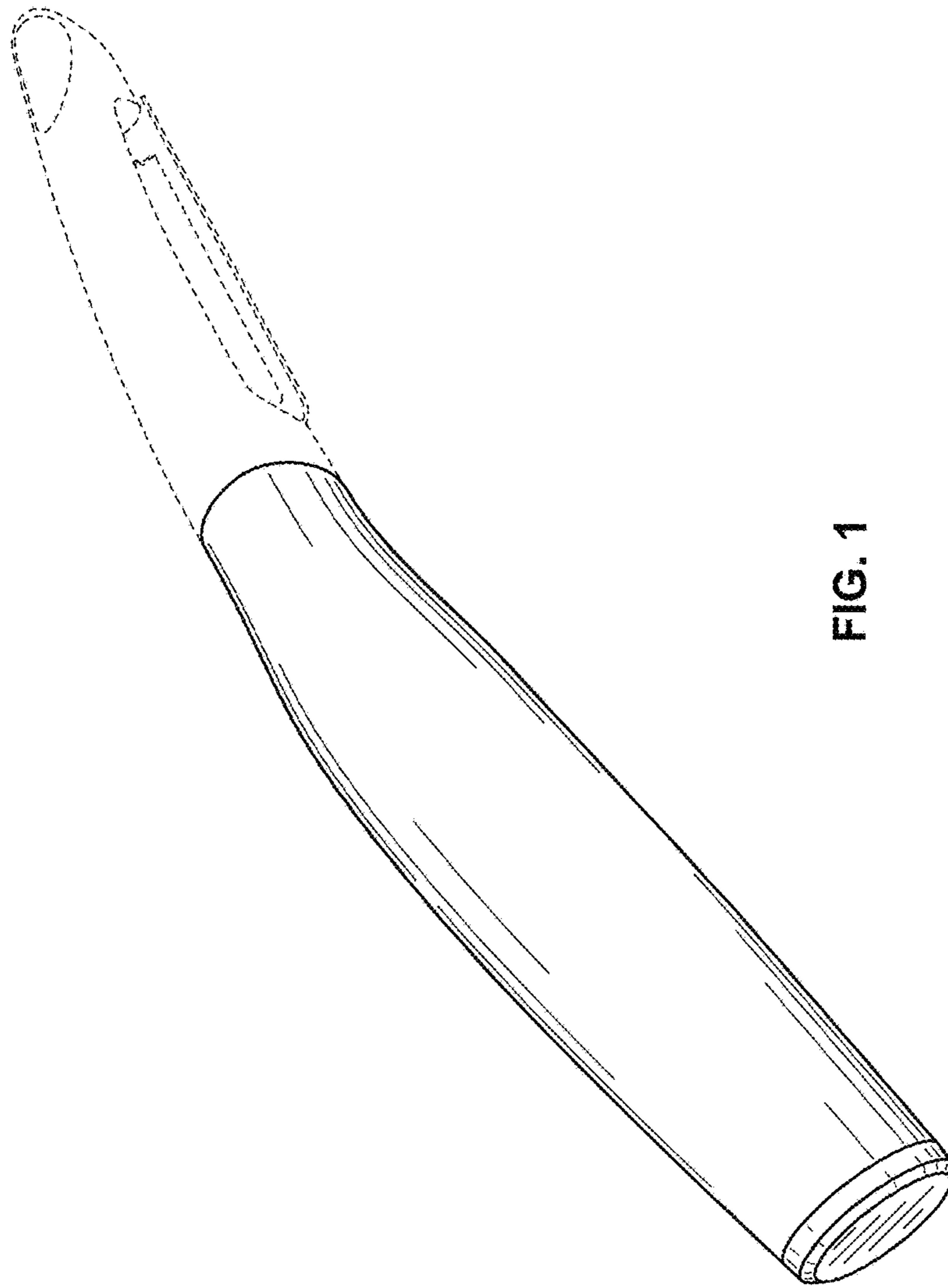

FIG. 1

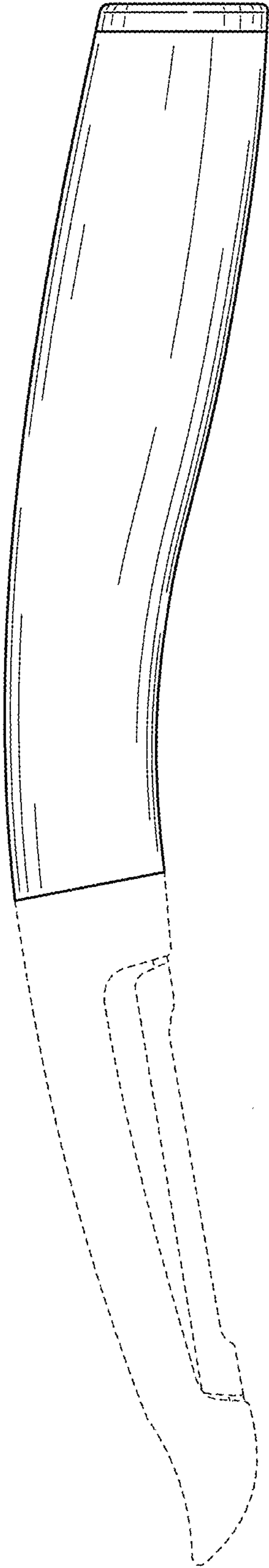

FIG. 2

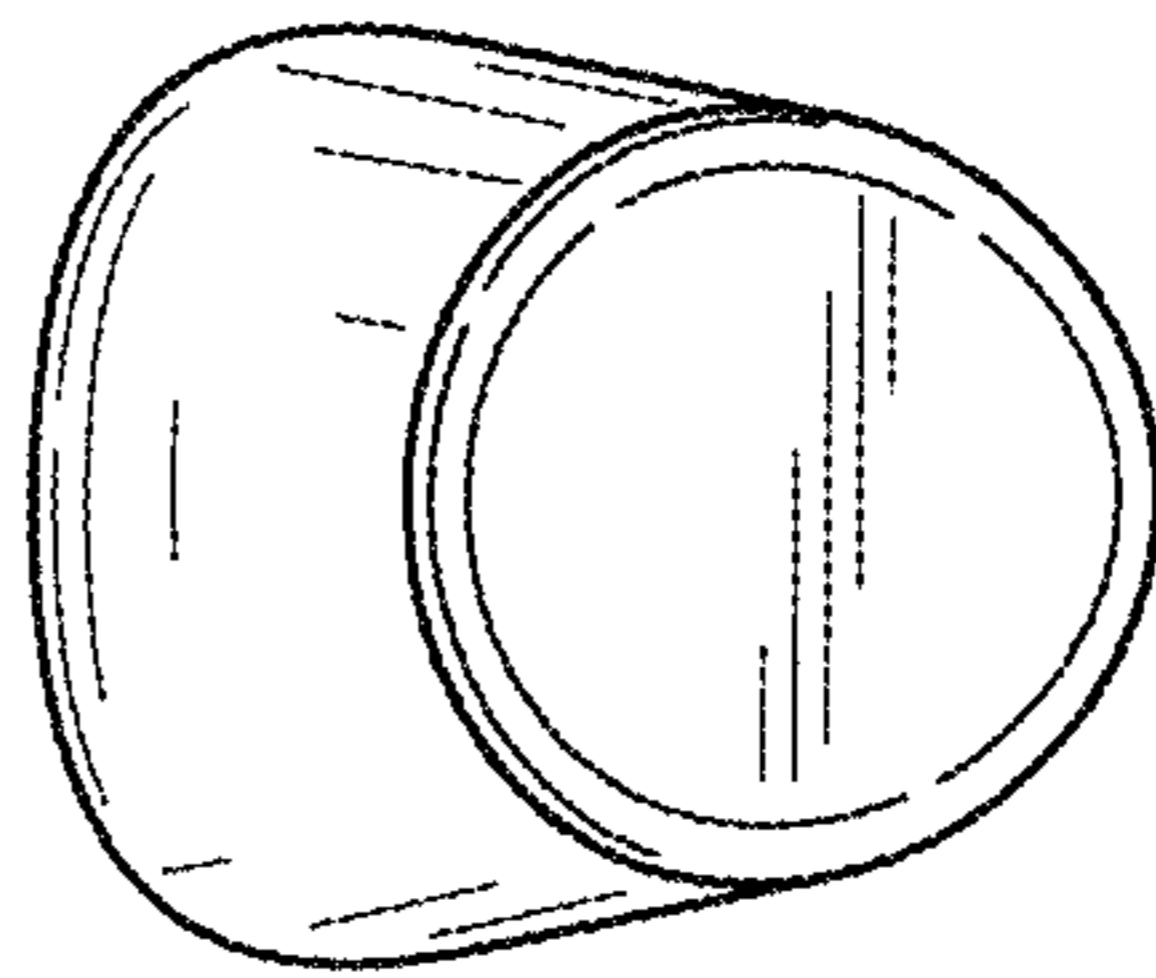

FIG. 3

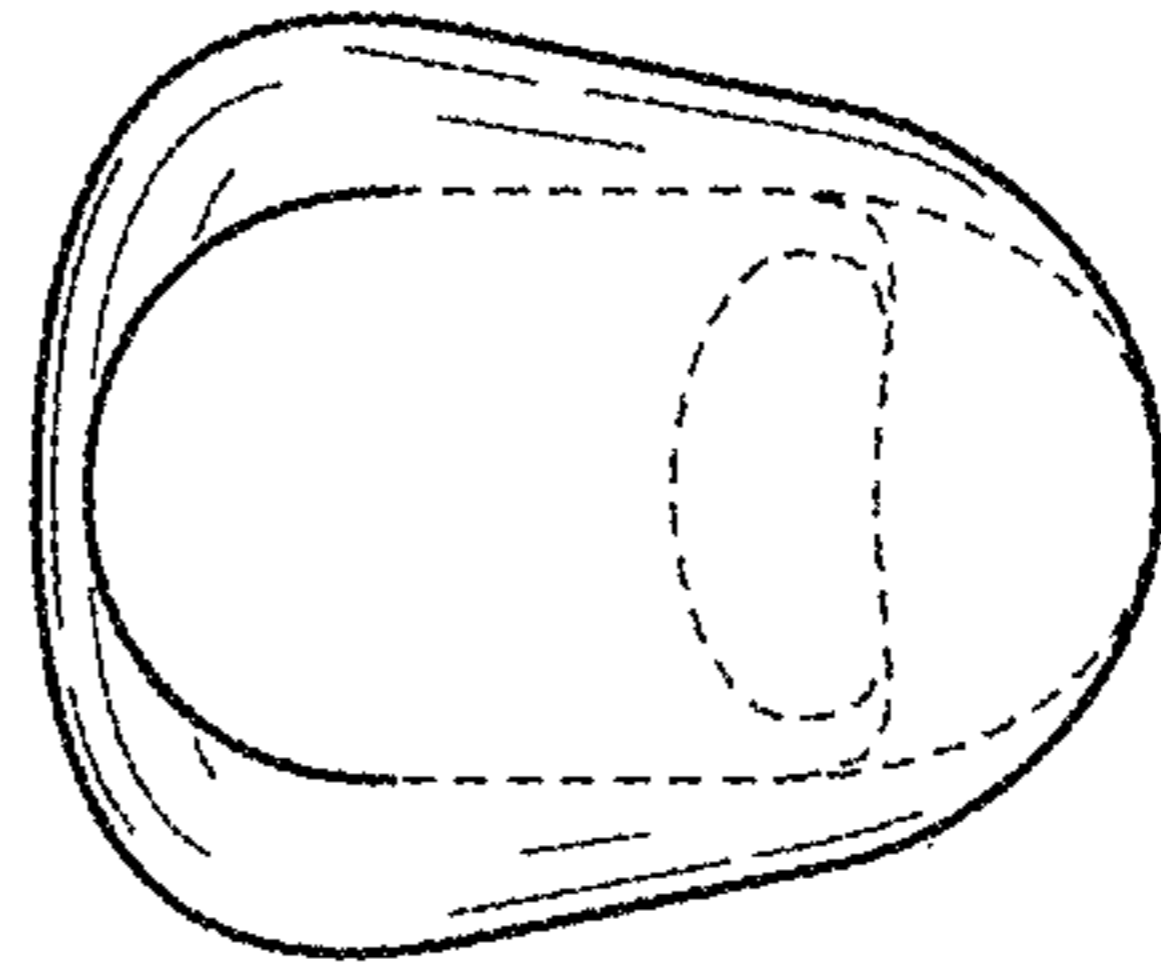

FIG. 4

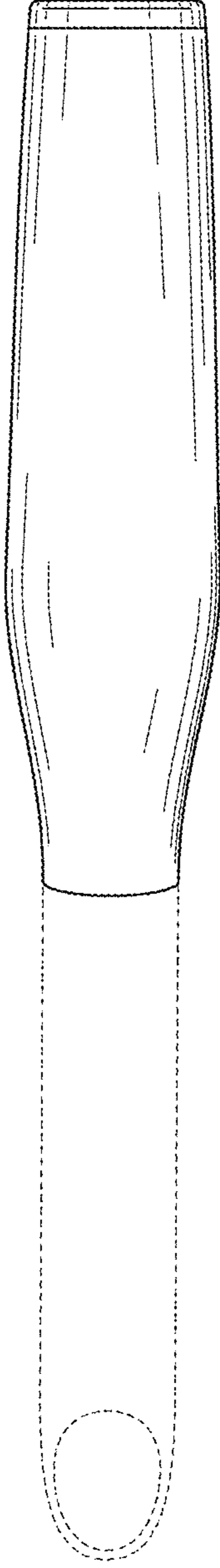

FIG. 5

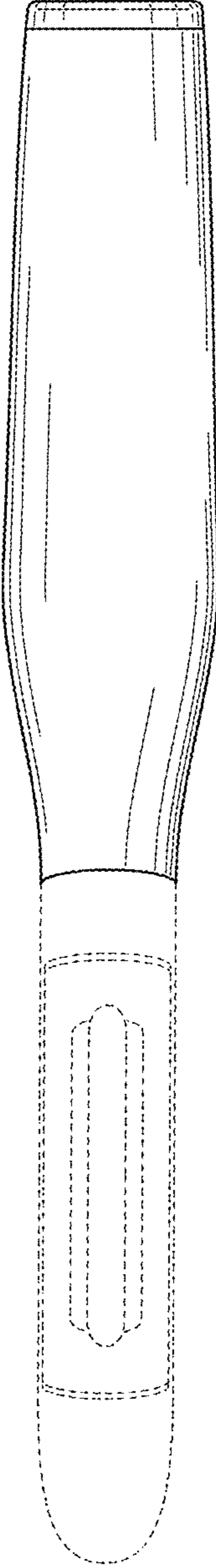

FIG. 6