



US00D791472S

(12) **United States Design Patent**
Krok et al.

(10) **Patent No.:** **US D791,472 S**

(45) **Date of Patent:** **** Jul. 11, 2017**

- (54) **TOOTHBRUSH HOLDER**
- (71) Applicants: **Paul Krok**, Culver City, CA (US);
Brian Steinhobel, Sandton (ZA)
- (72) Inventors: **Paul Krok**, Culver City, CA (US);
Brian Steinhobel, Sandton (ZA)
- (73) Assignee: **Bonfit America Inc.**, Culver City, CA (US)
- (**) Term: **15 Years**
- (21) Appl. No.: **29/527,649**
- (22) Filed: **May 20, 2015**
- (51) **LOC (10) Cl.** **03-02**
- (52) **U.S. Cl.**
USPC **D3/205**
- (58) **Field of Classification Search**
USPC D3/205; D9/748, 749; D6/534
CPC A45C 11/00; A45D 44/18
See application file for complete search history.

- 6,142,318 A * 11/2000 Tooma A47K 1/09
206/362
- D477,948 S * 8/2003 Paik D6/534
- D565,289 S * 4/2008 Christie D3/205
- D602,245 S * 10/2009 Christie D3/205
- D674,635 S * 1/2013 van der Lande D6/534
- D744,744 S * 12/2015 Lee D3/205

* cited by examiner

Primary Examiner — Charles Hanson

(74) *Attorney, Agent, or Firm* — Thomas I. Rozsa

(57) **CLAIM**

The ornamental design for a toothbrush holder, as shown and described.

DESCRIPTION

FIG. 1 is a top front left side perspective view of the toothbrush holder, showing our new design;
FIG. 2 is a bottom rear right side perspective view thereof;
FIG. 3 is front view thereof;
FIG. 4 is a rear view thereof;
FIG. 5 is a left side view thereof;
FIG. 6 is a right side view thereof;
FIG. 7 is a top plan view thereof; and,
FIG. 8 is a bottom plan view thereof.

1 Claim, 8 Drawing Sheets

(56) **References Cited**
U.S. PATENT DOCUMENTS

- D247,024 S * 1/1978 Hauf D3/205
- D379,280 S * 5/1997 Butler D6/534

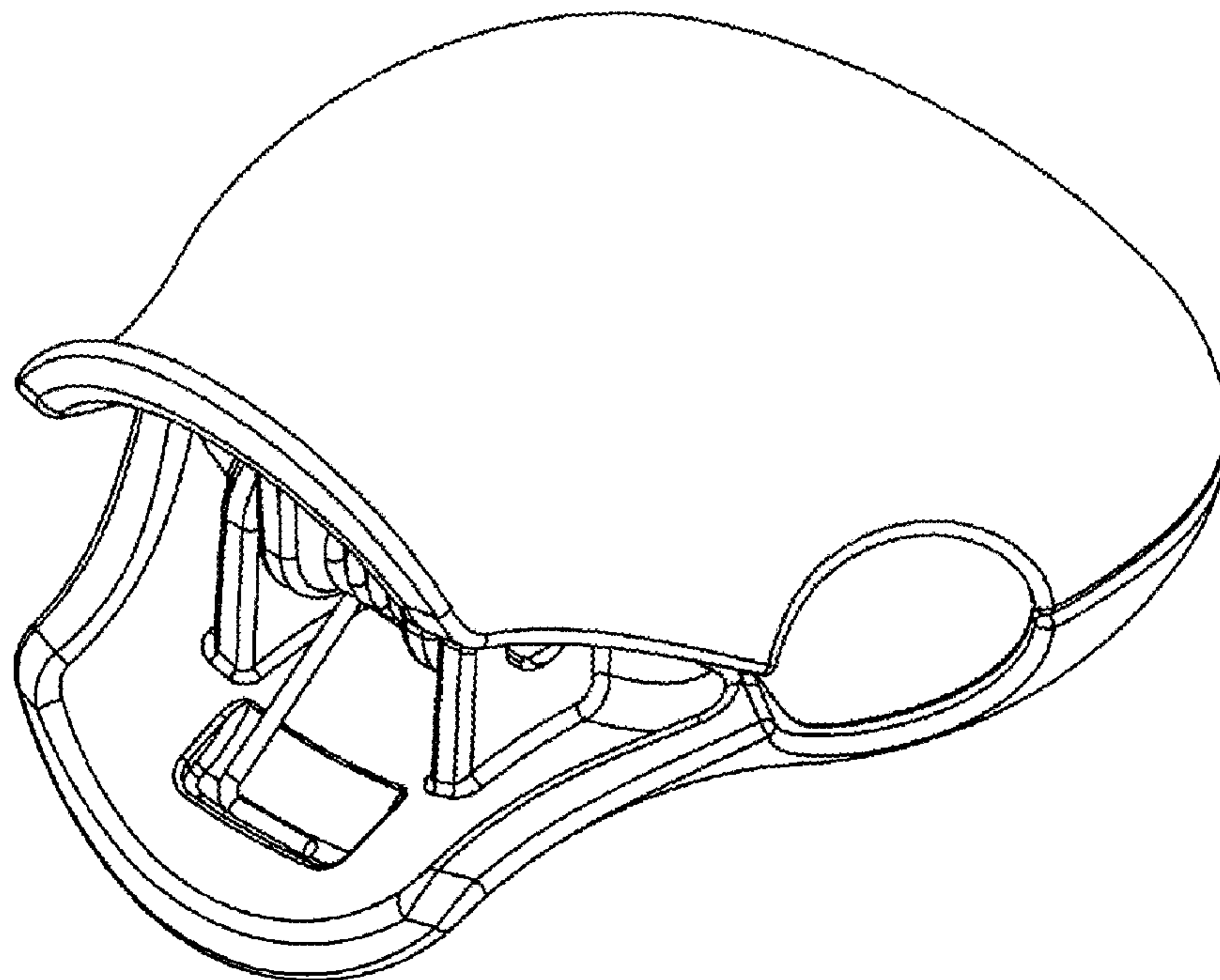

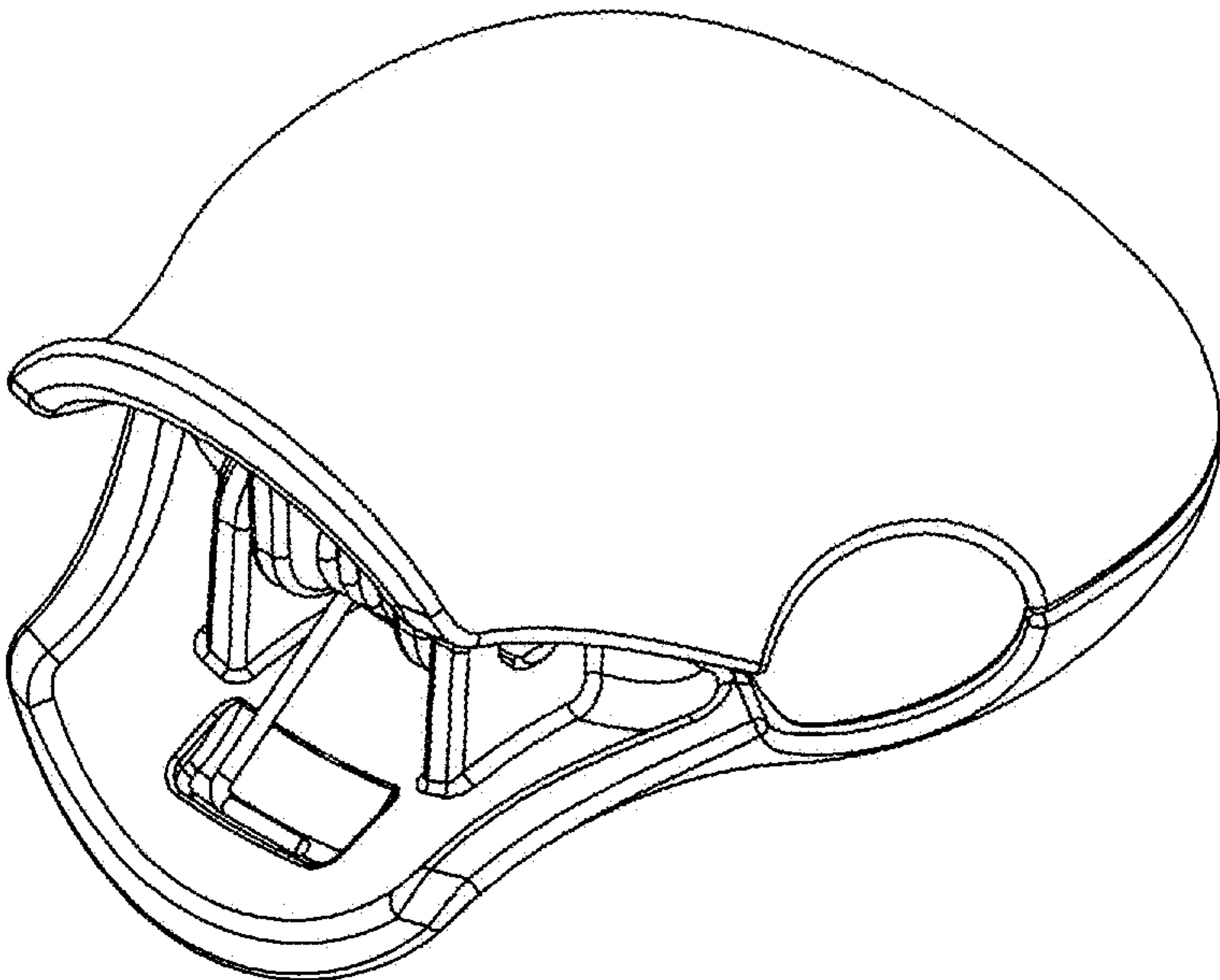

FIG. 1

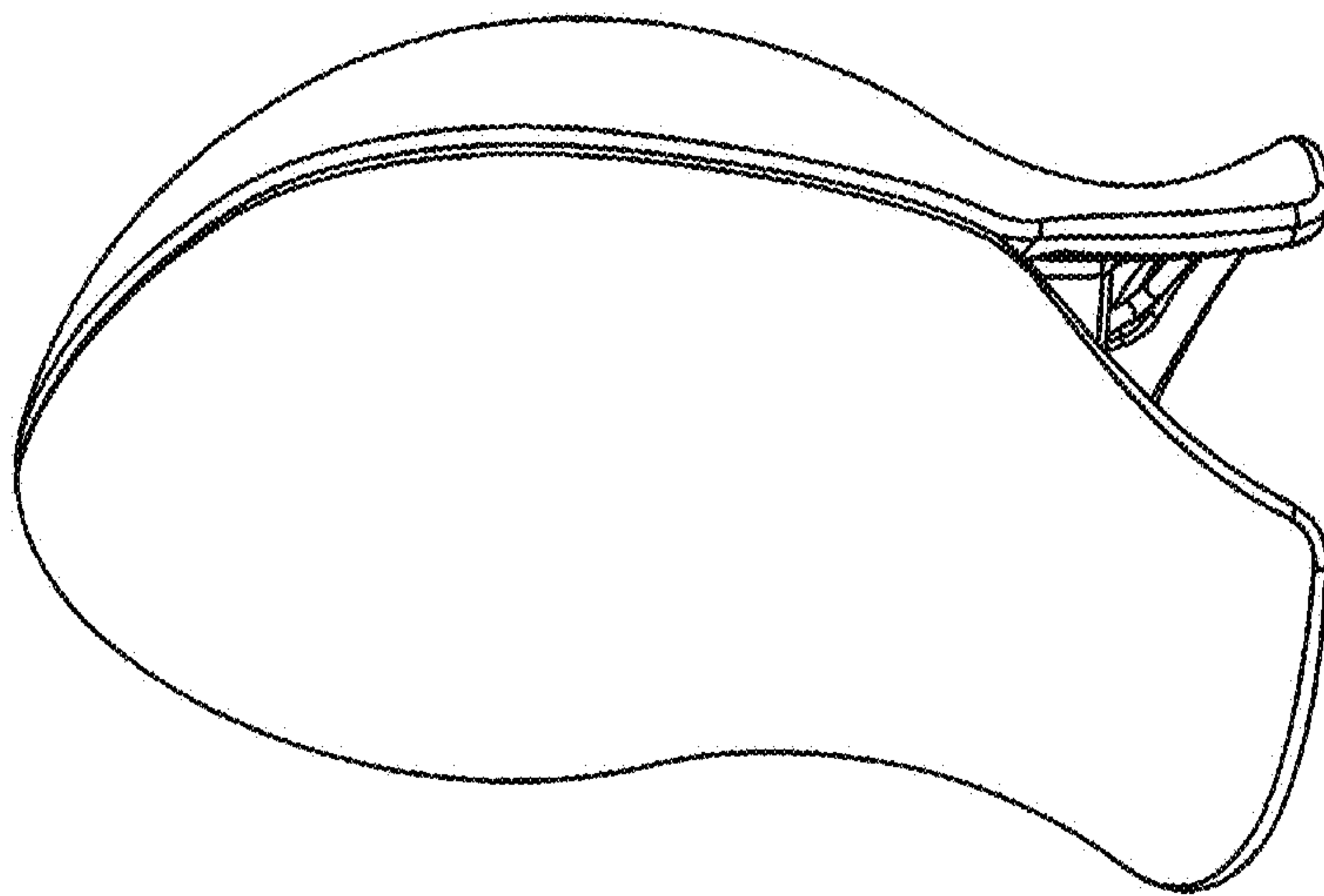

FIG. 2

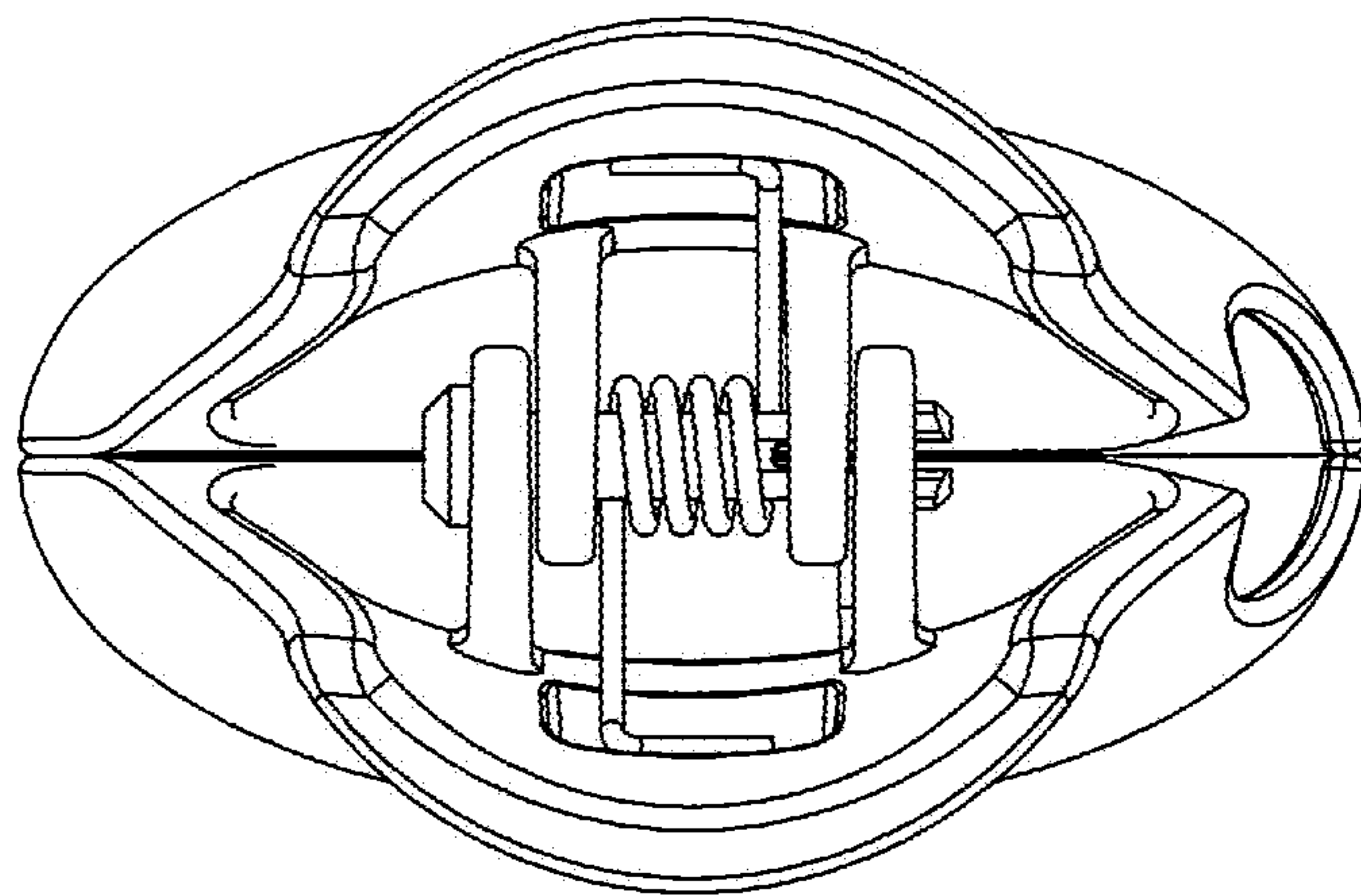

FIG. 3

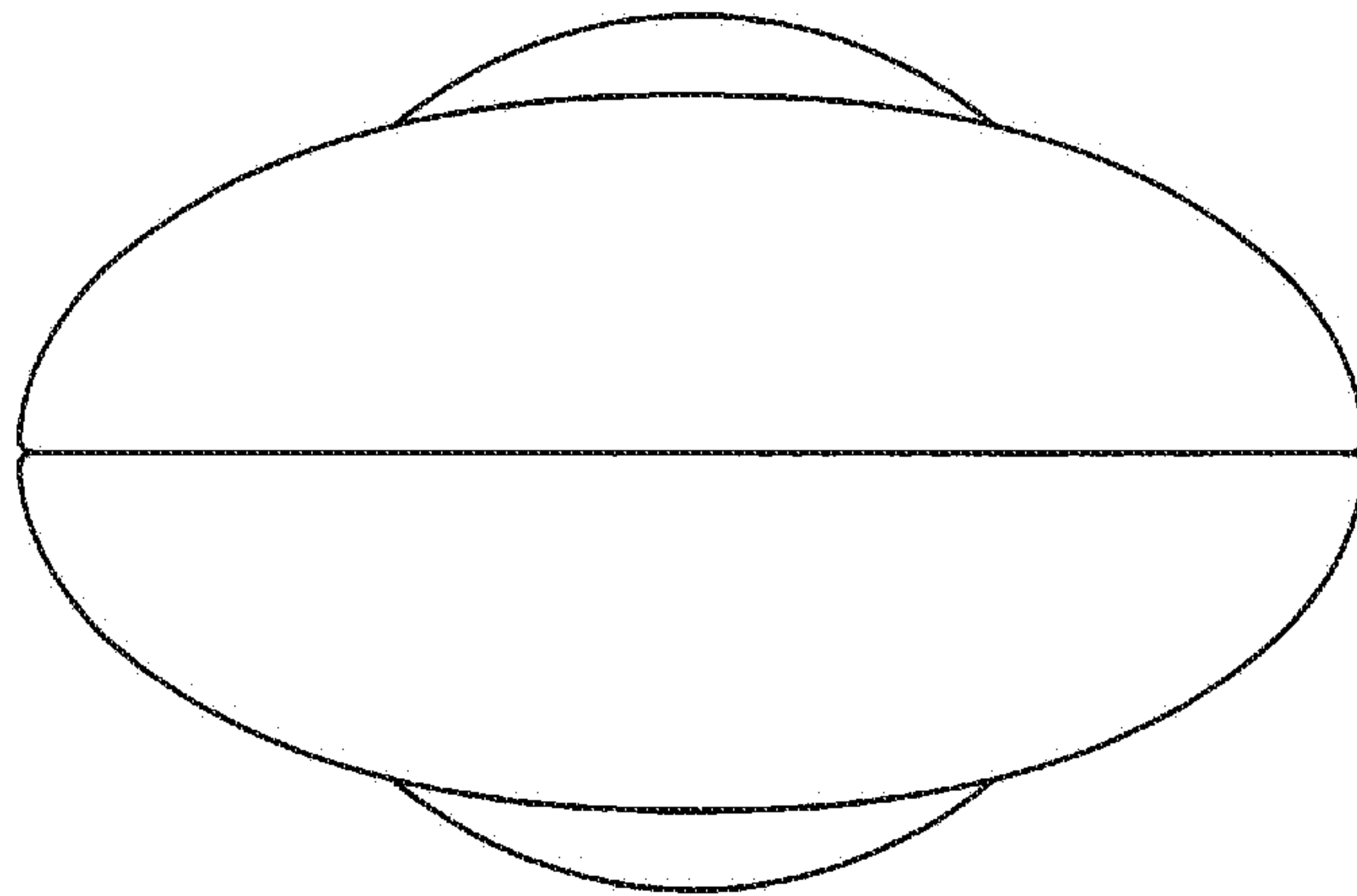

FIG. 4

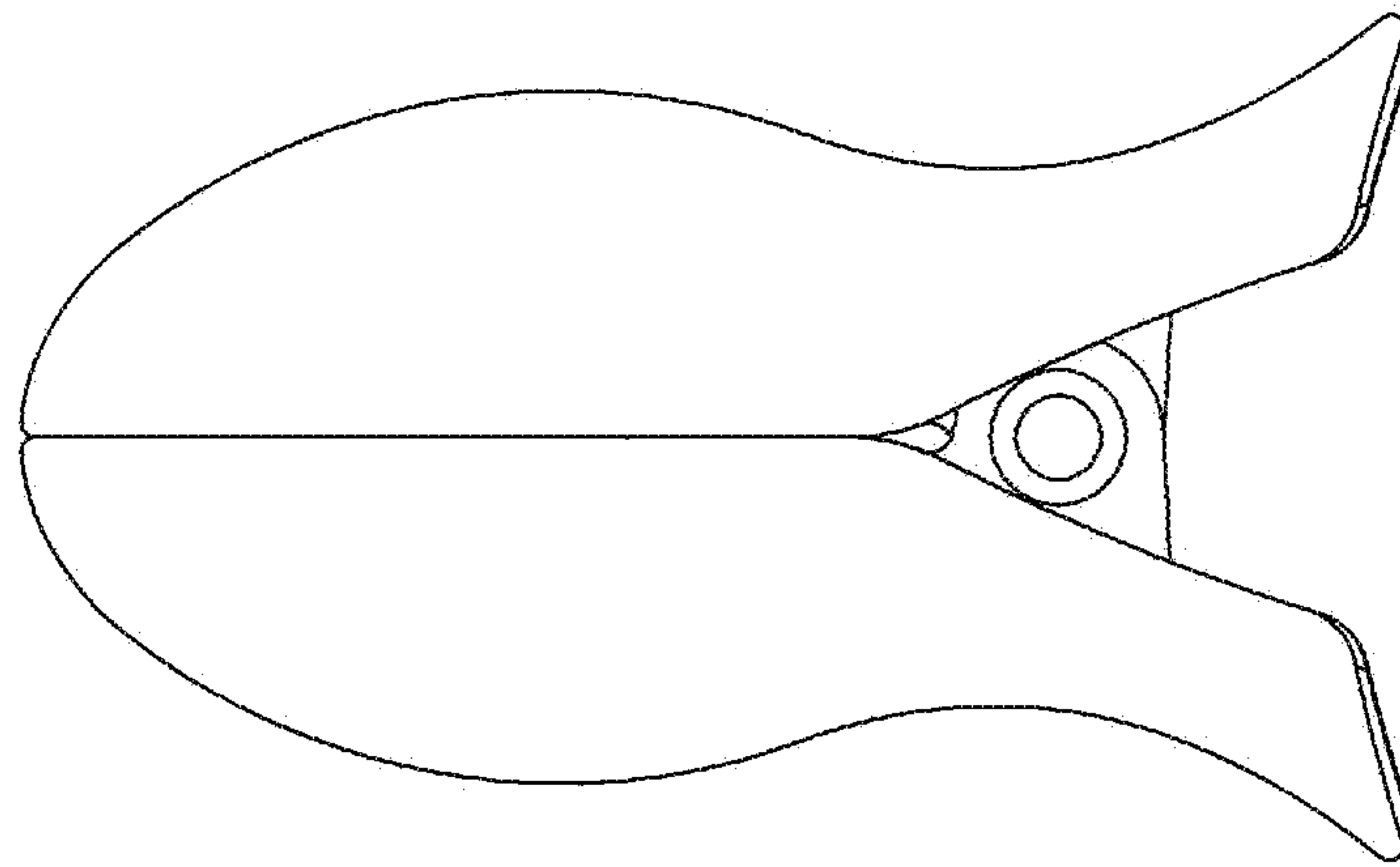

FIG. 5

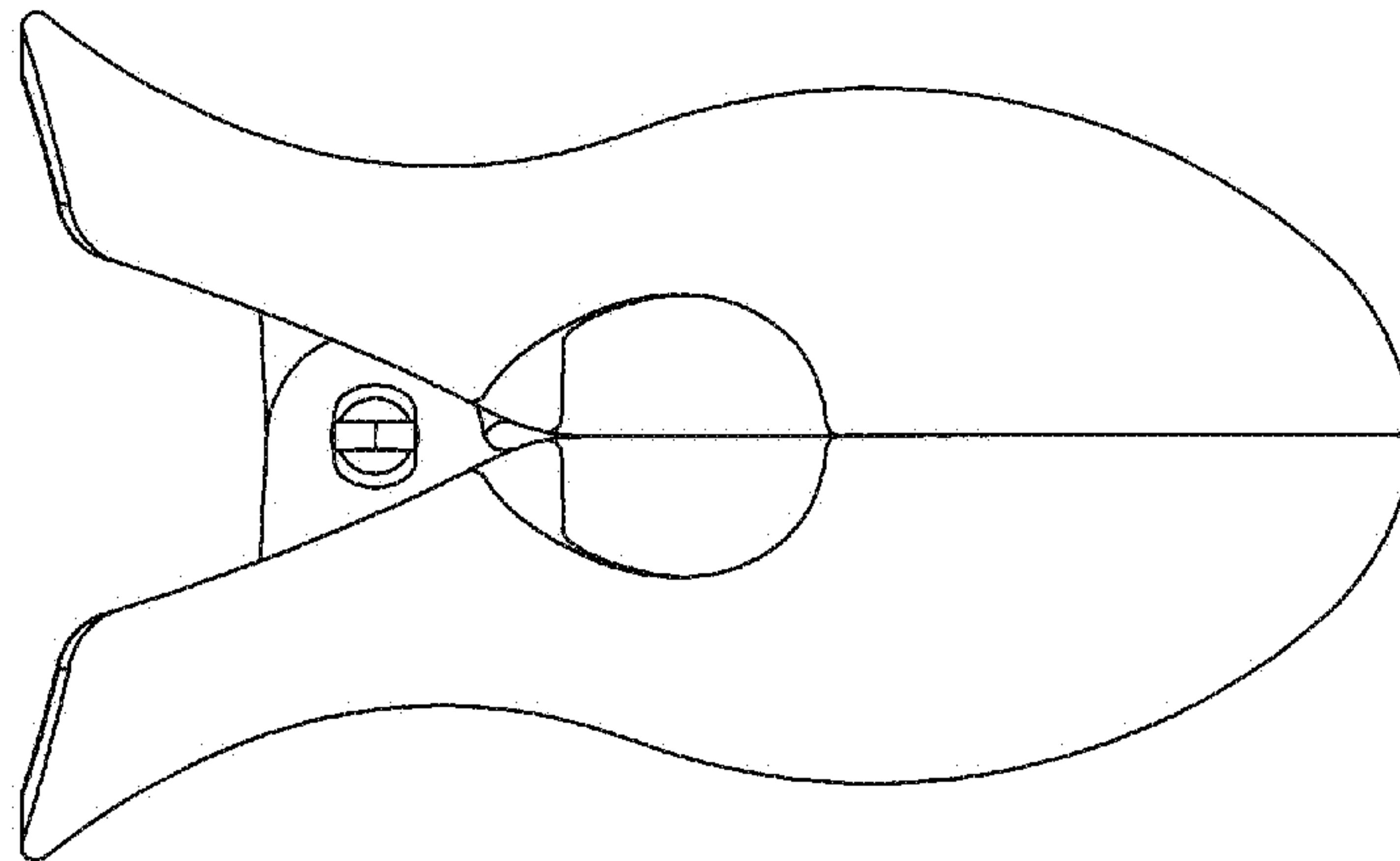

FIG. 6

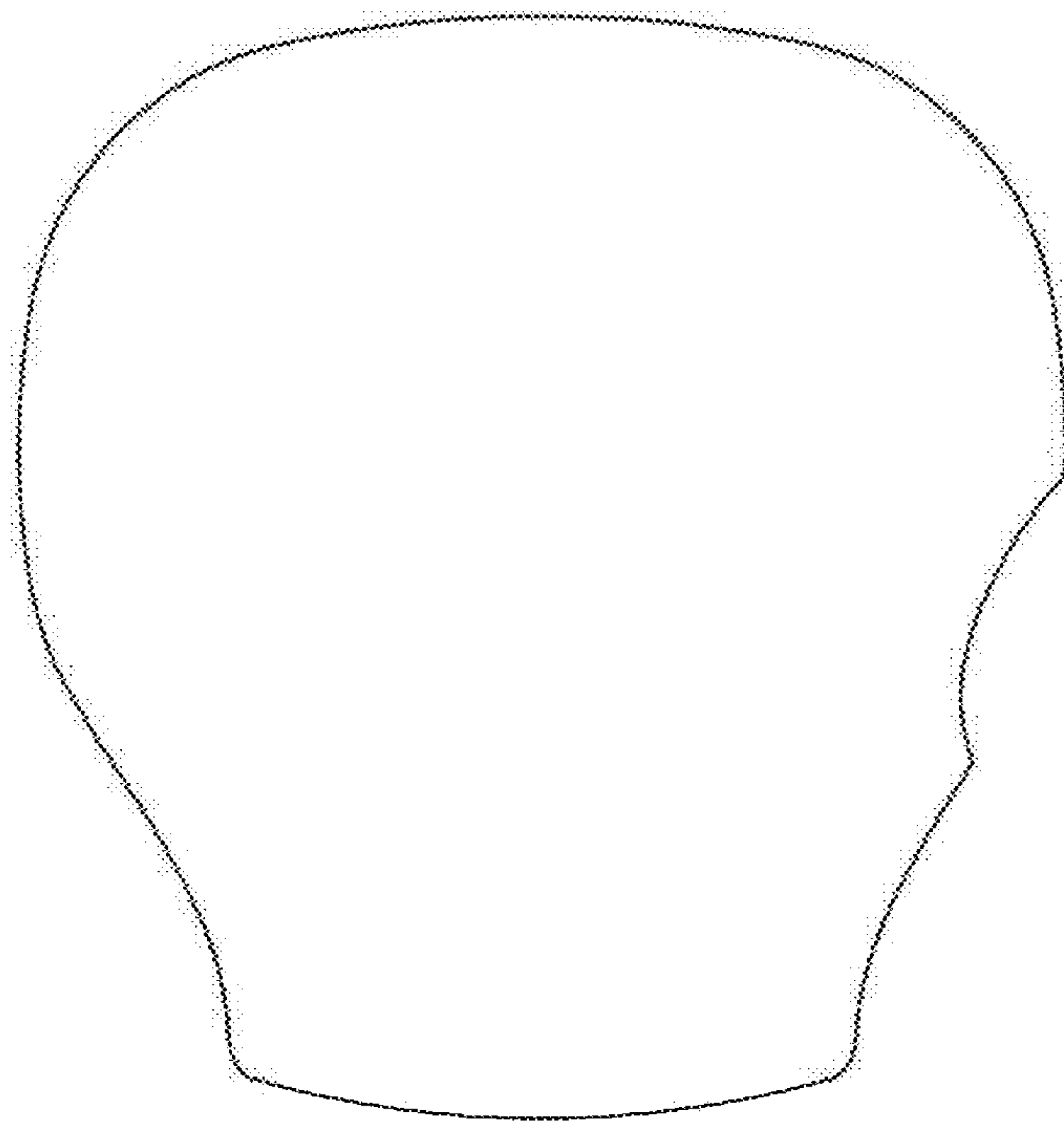

FIG. 7

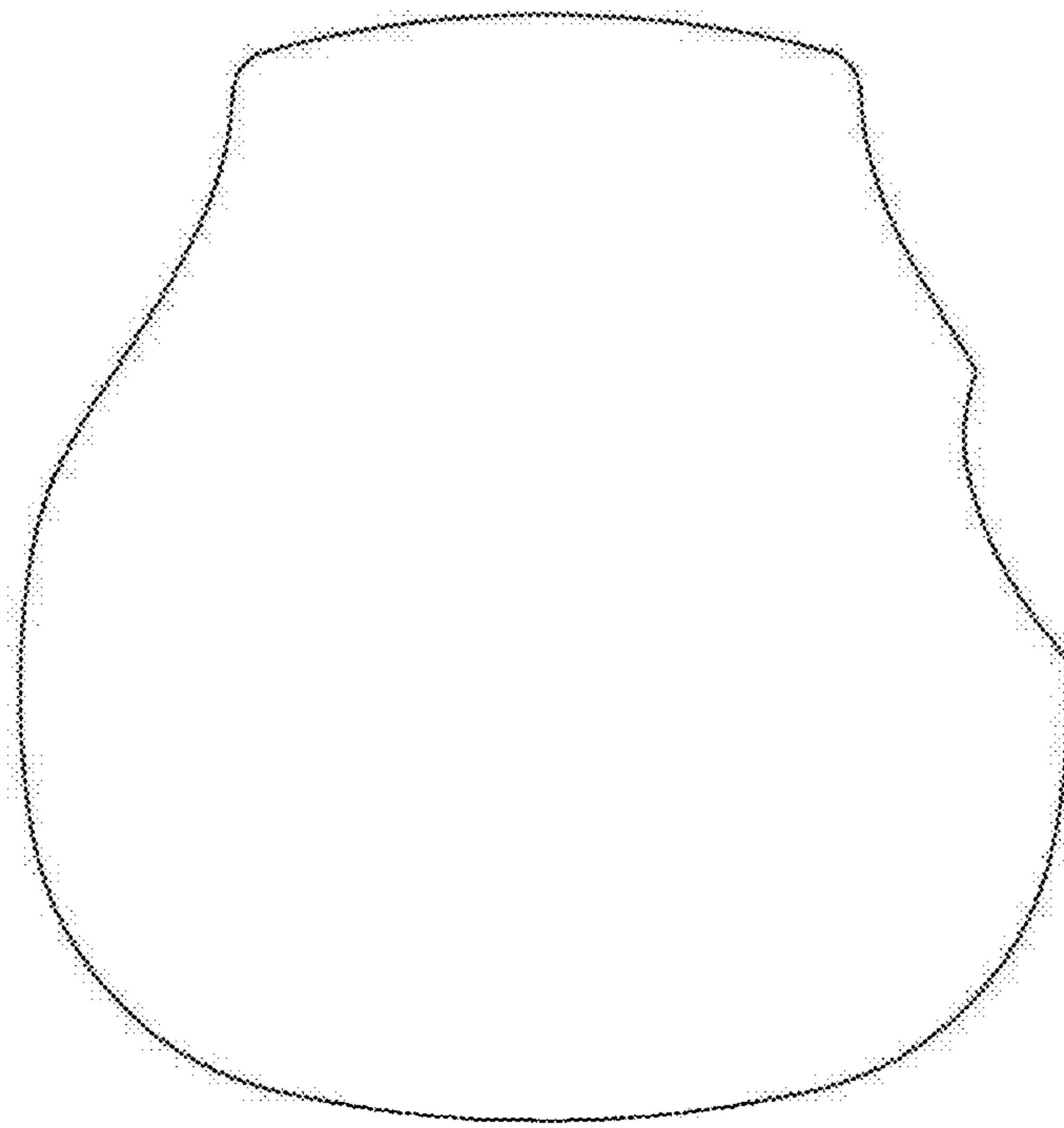

FIG. 8