



US00D791441S

(12) **United States Design Patent**
Van Sisseren

(10) **Patent No.:** **US D791,441 S**
(45) **Date of Patent:** **** Jul. 11, 2017**

(54) **GARMENT**

(71) Applicant: **NIKE, Inc.**, Beaverton, OR (US)

(72) Inventor: **Sheilah A. Van Sisseren**, Portland, OR (US)

(73) Assignee: **NIKE, Inc.**, Beaverton, OR (US)

(**) Term: **15 Years**

(21) Appl. No.: **29/545,809**

(22) Filed: **Nov. 16, 2015**

(51) **LOC (10) Cl.** **02-02**

(52) **U.S. Cl.**
USPC **D2/828**

(58) **Field of Classification Search**

USPC D2/700, 702, 703, 704, 705, 706-709, D2/713, 714, 717, 720-723, 728, 731, D2/737, 715, 743, 750, 793, 794, D2/828-830, 833, 836, 840, 847, 853; D3/211, 271.4; D7/606, 607, 625, 710; D21/631, 634, 635, 636, 643, 645, 646, D21/647, 804, 805; D29/100, 101.1, D29/101.3, 101.4; D30/145
CPC A41B 1/00; A41B 1/06; A41B 1/08; A41B 9/06; A41D 1/02; A41D 1/04; A41D 1/18; A41D 13/0015; A41D 15/00; A41D 15/005; A41D 3/00; A41D 3/02; A41D 3/04; A41D 27/10

See application file for complete search history.

(56) **References Cited**

U.S. PATENT DOCUMENTS

339,920 A 4/1886 Patjme
1,657,866 A 1/1928 Mooney
D113,203 S 1/1939 Feigenbaum
D113,204 S 1/1939 Zucker et al.
D115,592 S 7/1939 Shapiro et al.

D118,524 S 1/1940 Zelinka
D139,535 S 11/1944 Bauer
D139,536 S * 11/1944 Bauer D2/829
(Continued)

FOREIGN PATENT DOCUMENTS

GB 000796879 A 6/1958
WO 0011979 A1 3/2000

OTHER PUBLICATIONS

The Look of Winter: The 2015 Nike Tech Fleece Aeroloft Collection: Announced Oct. 15, 2015 [online], site visited Nov. 7, 2016. Available from Internet URL: <http://news.nike.com/news/2015-tech-fleece-aeroloft-collection>.*

(Continued)

Primary Examiner — Caron D Veynar

Assistant Examiner — Melvin Davis

(74) *Attorney, Agent, or Firm* — Banner & Witcoff, Ltd.

(57) **CLAIM**

The ornamental design for a garment, as shown and described.

DESCRIPTION

FIG. 1 is a front perspective view of a garment showing my new design;
FIG. 2 is a front view thereof;
FIG. 3 is a rear view thereof;
FIG. 4 is a side view thereof;
FIG. 5 is a second side view thereof;
FIG. 6 is a top view thereof; and,
FIG. 7 is a bottom view thereof.

The broken lines immediately adjacent to the shaded area define the bounds of the claimed design and form no part thereof. The broken lines showing the remainder of the garment represent unclaimed subject matter and form no part of the claimed design. The contrast in shading represents a contrast in appearance only and does not represent any particular color, material, texture or finish.

1 Claim, 7 Drawing Sheets

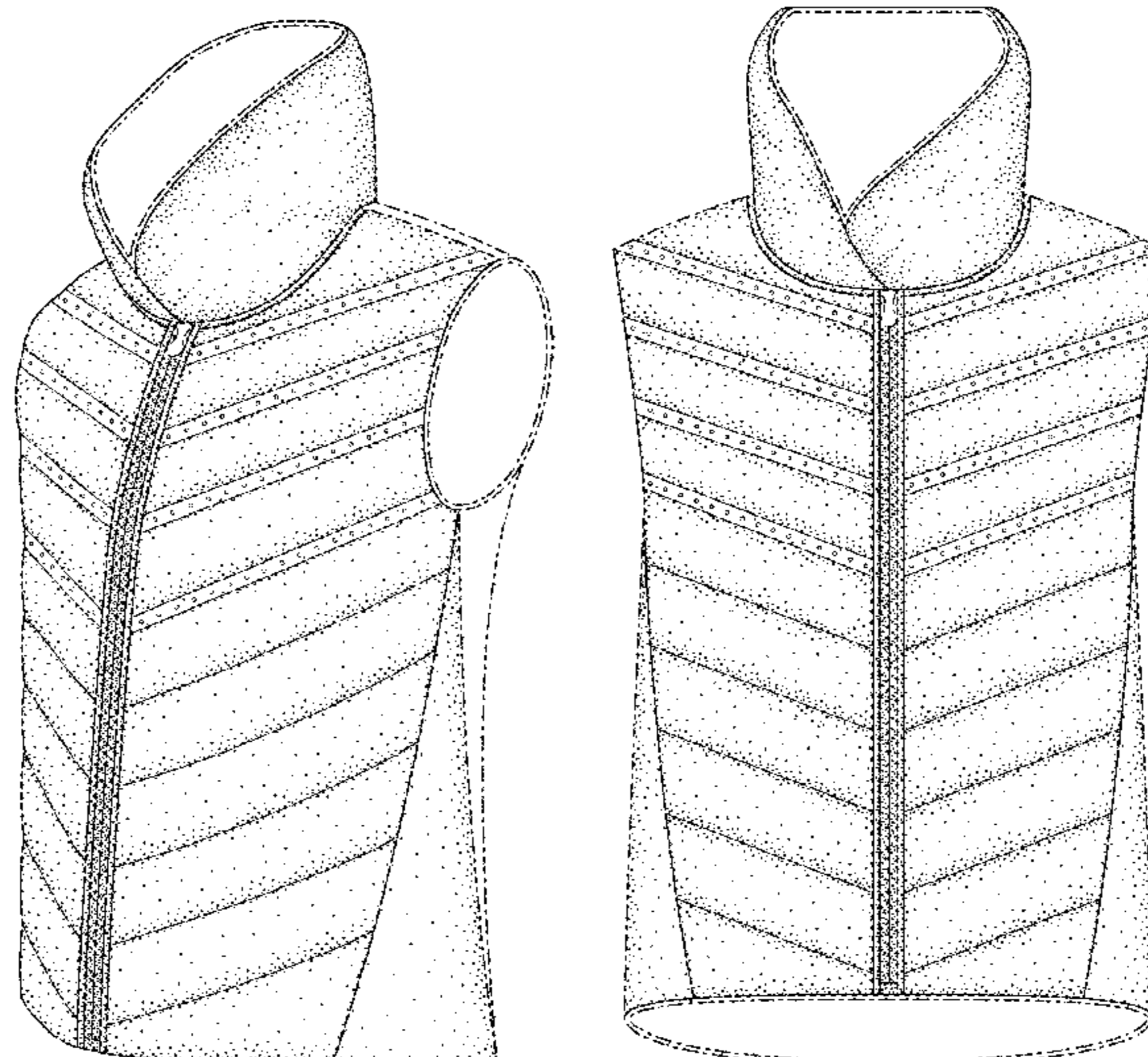

(56)

References Cited

U.S. PATENT DOCUMENTS

D157,696 S 3/1950 Paque
 2,669,721 A 2/1954 Max
 D194,967 S 4/1963 Bauer
 3,116,489 A 1/1964 Weiss
 3,398,406 A 8/1968 Du Pont
 3,883,914 A 5/1975 Blair
 3,988,780 A 11/1976 Armellino
 4,084,264 A 4/1978 Marion
 4,149,272 A 4/1979 Maeshima
 D255,056 S 5/1980 Parsons
 4,602,387 A 7/1986 Zakrzewski
 4,619,622 A 10/1986 McDonald et al.
 D294,305 S * 2/1988 Meek 2/94
 D298,474 S 11/1988 Twede
 5,465,424 A 11/1995 Cudney et al.
 D367,551 S 3/1996 Chalbeck et al.
 D374,329 S 10/1996 Wilde
 D385,088 S 10/1997 Handysides
 D414,913 S 10/1999 Katz et al.
 D478,708 S 8/2003 Miros et al.
 D479,902 S 9/2003 Brown
 6,654,963 B2 12/2003 Fayle et al.
 D516,777 S 3/2006 Beck
 D541,010 S 4/2007 Boucher
 D580,632 S 11/2008 Adams et al.
 D588,783 S 3/2009 Olstorn
 D618,440 S 6/2010 Parker
 D620,231 S 7/2010 Parker
 D621,132 S 8/2010 Crisp
 D622,032 S 8/2010 Lambertz
 D622,033 S 8/2010 Lambertz
 D622,034 S 8/2010 Lambertz
 D622,035 S 8/2010 Lambertz
 D625,078 S 10/2010 Scott-Curran
 D626,725 S 11/2010 Snyder et al.
 D631,230 S 1/2011 Ruffini
 D633,690 S 3/2011 Tronvold
 D633,691 S 3/2011 Tronvold
 D636,973 S 5/2011 Smith et al.
 D637,794 S 5/2011 Gosse
 D638,200 S 5/2011 Gorson
 D638,201 S 5/2011 Gosse
 D638,202 S 5/2011 Gosse
 D639,023 S 6/2011 lamartino et al.
 D641,137 S 7/2011 Evans et al.
 D642,770 S 8/2011 Bengyak
 D643,577 S 8/2011 Bulan et al.
 D653,430 S 2/2012 Pouches
 D654,659 S 2/2012 Scott-Curran
 D654,664 S 2/2012 Evans et al.
 D656,301 S 3/2012 Randall
 D662,282 S 6/2012 Meunier-Bouchard
 D662,285 S 6/2012 Rushworth
 D667,169 S * 9/2012 Miller D29/101.3
 D675,400 S 2/2013 Mertes
 D679,072 S 4/2013 Abbevik et al.
 D685,158 S 7/2013 Lambertz
 D685,159 S 7/2013 Lambertz
 D685,160 S 7/2013 Savage
 D687,619 S 8/2013 Savage
 D689,262 S 9/2013 Passman
 D689,263 S 9/2013 Passman
 D693,095 S 11/2013 Grant
 D695,491 S 12/2013 Hawkins et al.
 D698,123 S 1/2014 Yu et al.
 D698,525 S 2/2014 Roberts et al.
 D698,526 S 2/2014 Roberts et al.
 D698,528 S 2/2014 Roberts et al.
 D702,419 S 4/2014 Mertes
 D702,920 S 4/2014 Chaney
 D703,922 S 5/2014 Roberts et al.
 D704,418 S 5/2014 Holmes
 D704,419 S 5/2014 Holmes
 D704,924 S 5/2014 Roberts et al.
 D707,423 S 6/2014 Pezzimenti

D707,424 S 6/2014 Pezzimenti
 D710,573 S 8/2014 Pezzimenti
 D713,128 S 9/2014 Pezzimenti et al.
 D713,620 S 9/2014 Pezzimenti et al.
 D713,621 S 9/2014 Pezzimenti et al.
 D714,022 S 9/2014 Mong et al.
 D714,526 S 10/2014 Ingram
 D714,527 S 10/2014 Borovicka
 D716,022 S 10/2014 Judge et al.
 D719,722 S 12/2014 Bublak
 D733,404 S * 7/2015 Garneau D2/850
 D734,922 S * 7/2015 Docker D2/829
 D736,497 S 8/2015 Harris
 D746,548 S 1/2016 Ingram
 D746,551 S 1/2016 Ingram
 D747,849 S * 1/2016 Ingram D2/829
 D748,374 S * 2/2016 Ingram D2/828
 D762,047 S * 7/2016 Clement D2/829
 D770,138 S * 11/2016 Borovicka D2/828
 D770,730 S * 11/2016 Borovicka D2/828
 2004/0153012 A1 8/2004 Schroeder
 2007/0294800 A1 * 12/2007 Huang A41D 3/00
 2/97
 2013/0276201 A1 10/2013 Pezzimenti
 2015/0060430 A1 * 3/2015 Tsuge H05B 1/0272
 219/211
 2016/0029725 A1 * 2/2016 Dee A41D 31/0038
 2/85

OTHER PUBLICATIONS

Nikelab Presents ACG: Defining Sport Utility for the City Announced Dec. 16, 2014[online], site visited Nov. 8, 2016, Available from Internet URL: <http://news.nike.com/news/nike-acg-defining-sport-utility-for-the-city>.*
 Nike Apparel Catalog, 2010 Fall ACG, p. 15, published date unknown, but prior to the filing date of the present application, NIKE, Inc., USA.
 Nike Apparel Catalog, 2010 Fall ACG, p. 16, published date unknown, but prior to the filing date of the present application, NIKE, Inc., USA.
 Nike Apparel Catalog, 2010 Fall Apparel, p. 17, published 2010, Nike, Inc., USA.
 Nike Apparel Catalog, 2010 Fall Apparel, p. 20, published date unknown, but prior to the filing date of the present application, NIKE, Inc., USA.
 Nike Apparel Catalog, 2010 Holiday Women's Athletic Department Classics, p. 9, published 2010, NIKE, Inc., USA.
 Nike Apparel Catalog, 2010 Holiday Young Athletes, p. 47, published date unknown, but prior to the filing date of the present application, NIKE, Inc., USA.
 Nike Apparel Catalog, 2010 Holiday Young Athletes p. 62, published date unknown, but prior to the filing date of the present application, NIKE, Inc., USA.
 Nike Apparel Catalog, 2011 Fall Boys' Apparel, p. 22, published 2011, NIKE, Inc., USA.
 Nike Apparel Catalog, 2011 Fall Girls' Apparel, p. 8, published 2011, NIKE, Inc., USA.
 Nike Apparel Catalog, 2011 Fall Men's Athletic Department Classics, p. 57, published 2011, NIKE, Inc., USA.
 Nike Apparel Catalog, 2011 Holiday Boy, p. 25, published date unknown, but prior to the filing date of the present application, NIKE, Inc., USA.
 Nike Apparel Catalog, 2011 Holiday Girls, p. 12 published date unknown, but prior to the filing date of the present application, NIKE, Inc., USA.
 Nike Apparel Catalog, 2011 Holiday Men's Athletic Dept Classic, p. 1, published date unknown, but prior to the filing date of the present application, NIKE, Inc., USA.
 Nike Apparel Catalog, 2011 Holiday Women's Performance, p. 51, published date unknown, but prior to the filing date of the present application, NIKE, Inc., USA.

(56)

References Cited

OTHER PUBLICATIONS

London Cyclist, "Waterproof cycling jacket guide," <http://www.londoncyclist.co.uk/waterproof-cycling-jacket/>, retrieved from internet Jan. 22, 2016, published Oct. 21, 2010, pp. 3-4.

Bike Lights Review, "Altura Night Vision Evo Jacket Review," <http://www.bikelightsreview.com/jackets/altura-night-vision-evo/>, retrieved from the internet Jan. 22, 2016, published Sep. 11, 2011, p. 2.

The Greatcaster, "Columbia Sportswear TurboDown Insulation," <http://www.thegearcaster.com/2013/11/columbia-sportswear-turbodown-insulation.html>, retrieved from internet Jan. 22, 2016, published Nov. 13, 2013, p. 2.

Blurgh The Thinkgeek Blog, "Top Ten List: Top 10 Fictional Uniforms We Want to Wear to Work," <http://www.thinkgeek.com/blog/2015/03/tldr-top-ten-list-top-10-ficti-2.html>, retrieved from internet Jan. 22, 2016, published date unknown, but prior to the filing date of the present application, pp. 1-4.

Nike Apparel Catalog, 2010 Fall ACG, p. 4, published date unknown, but prior to the filing date of the present application, NIKE, Inc., USA.

* cited by examiner

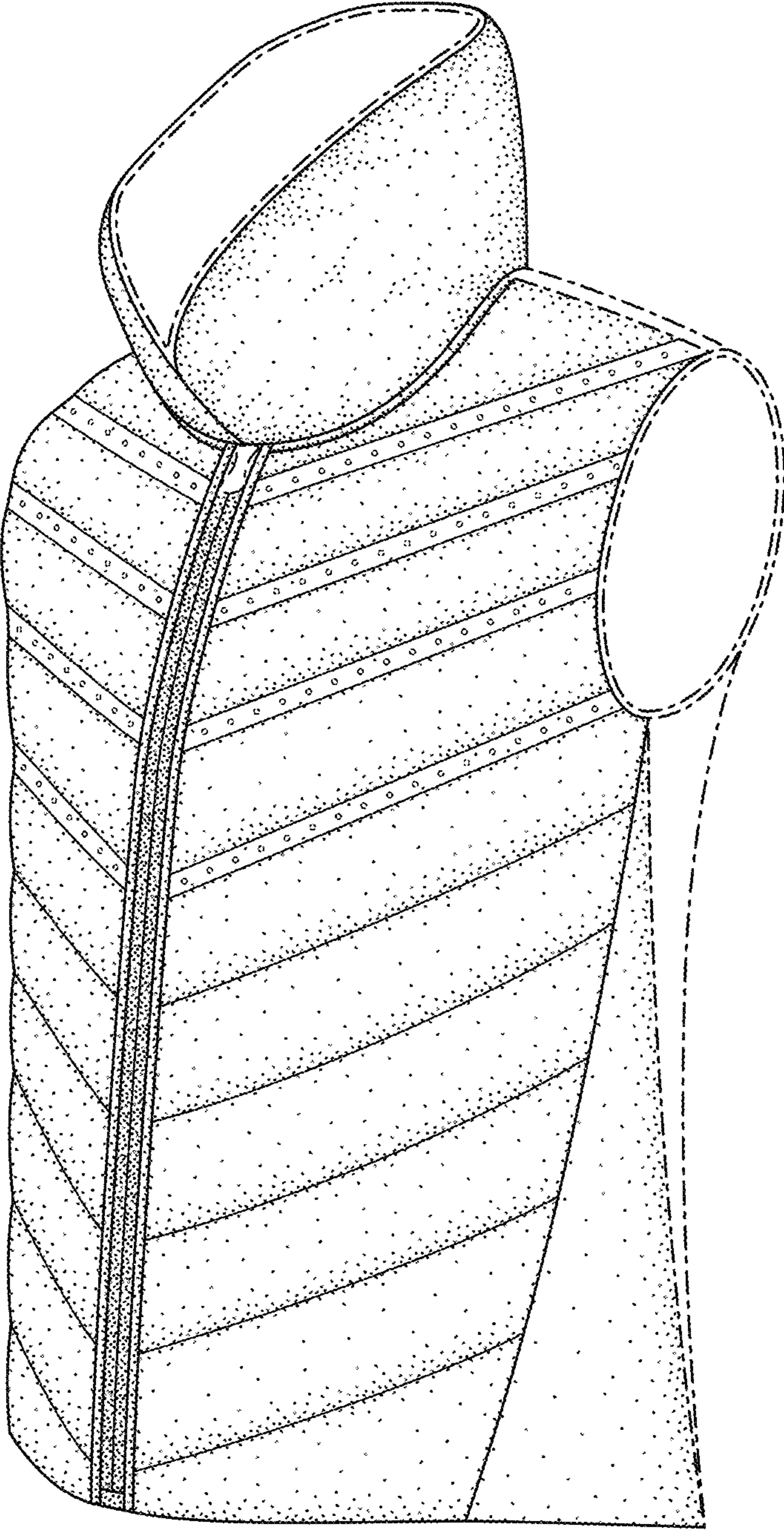

FIG. 1

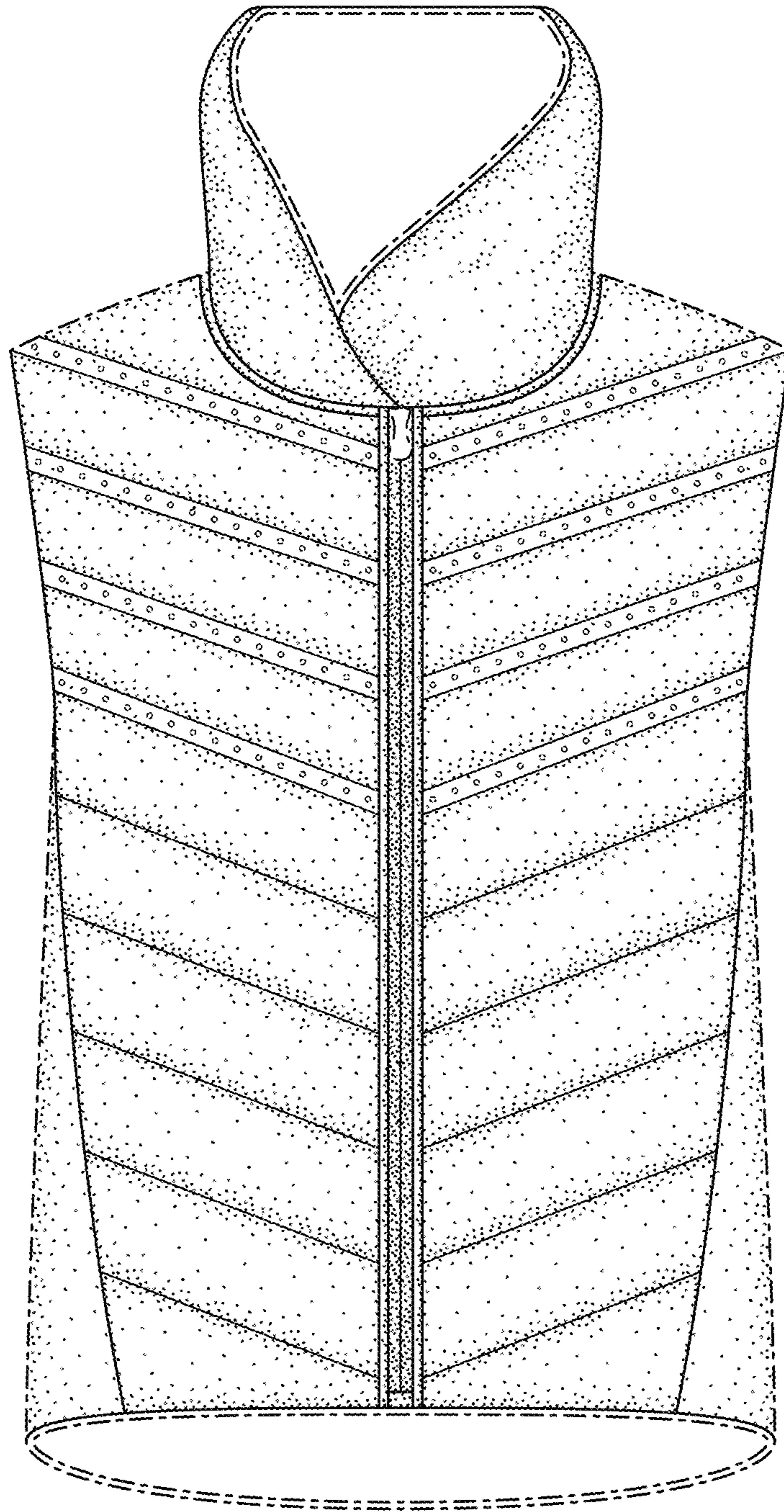

FIG. 2

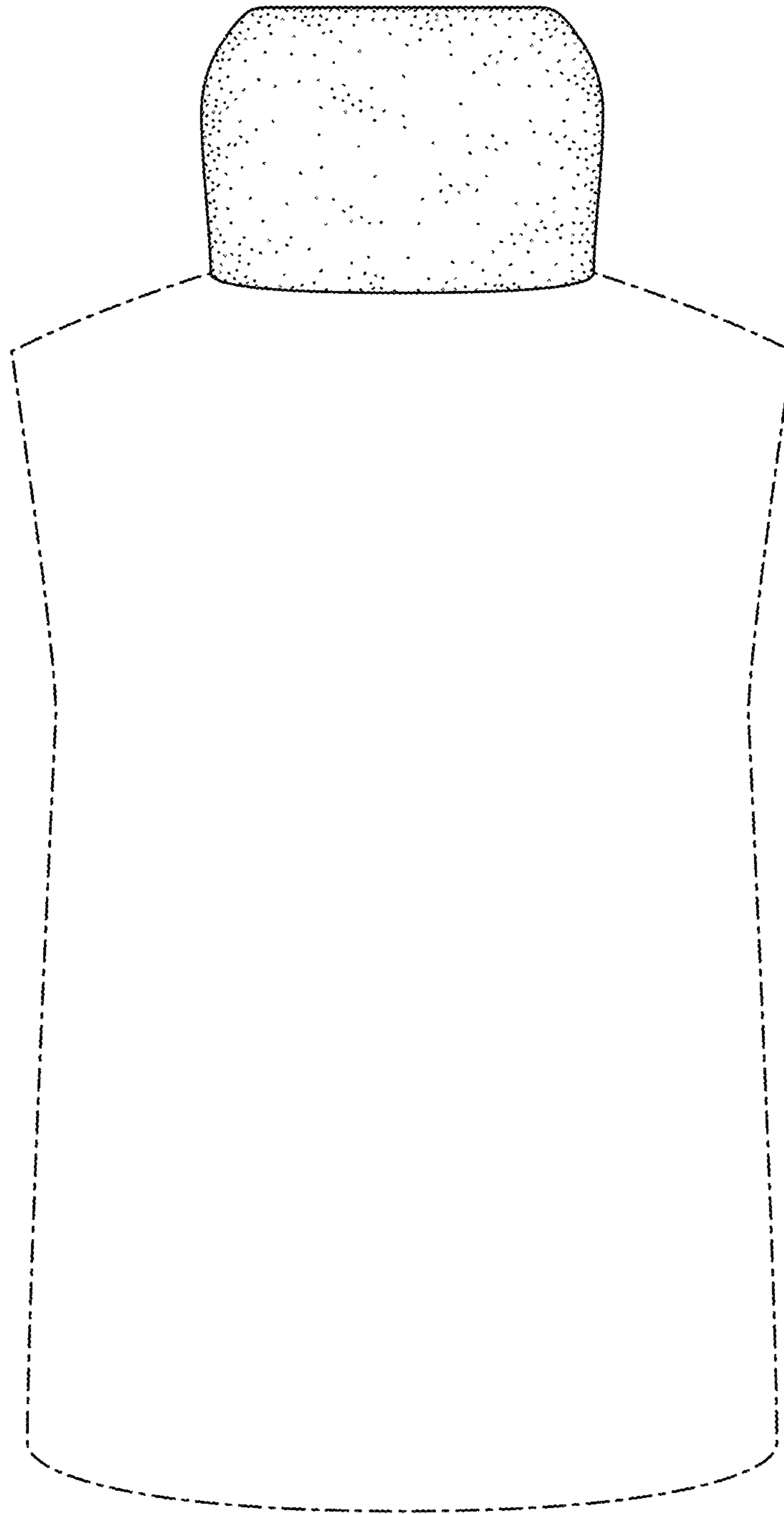

FIG. 3

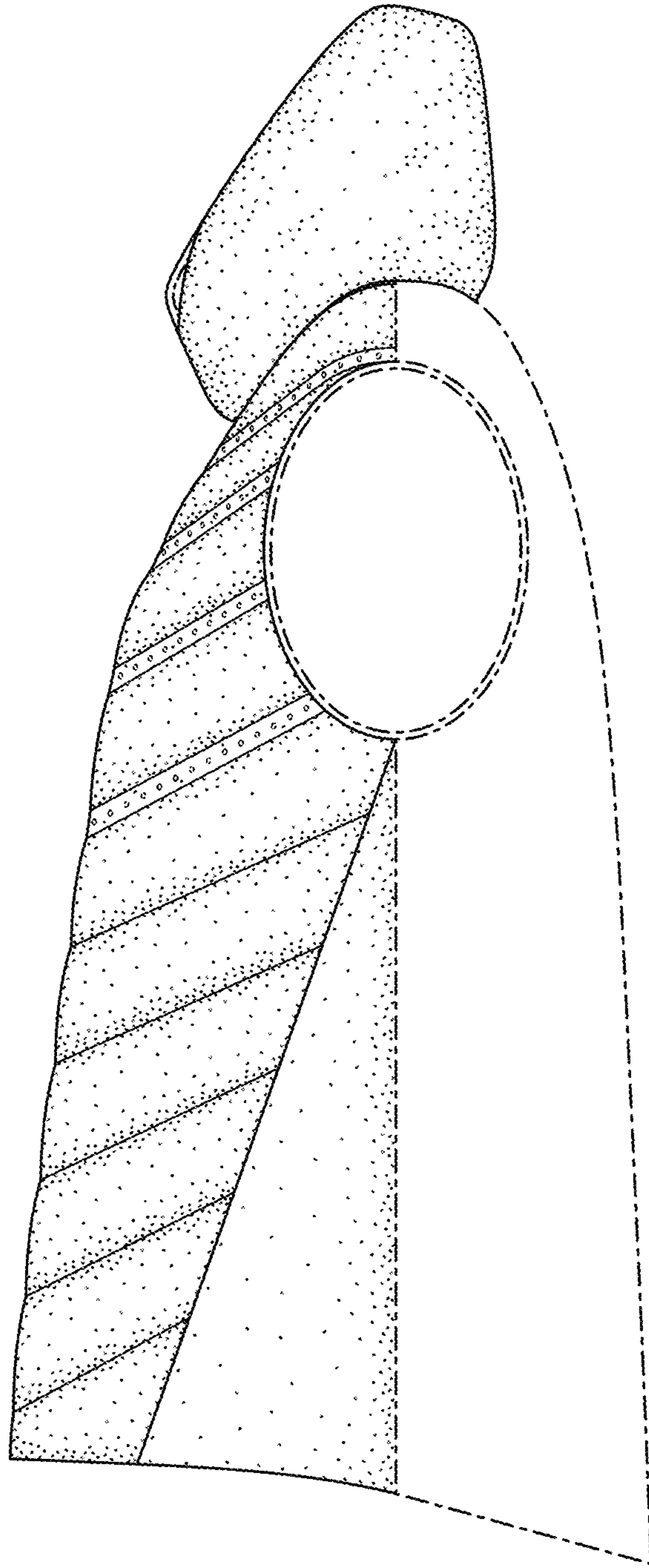

FIG. 4

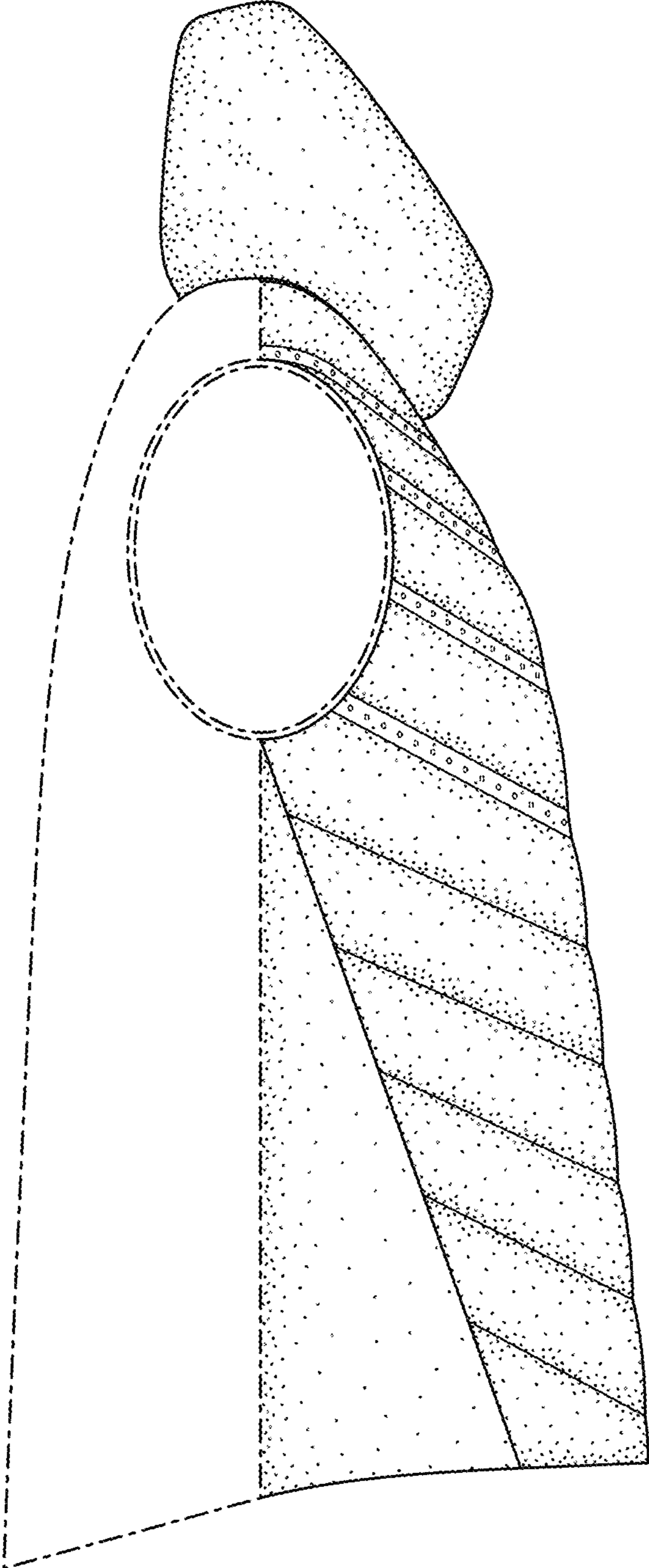

FIG. 5

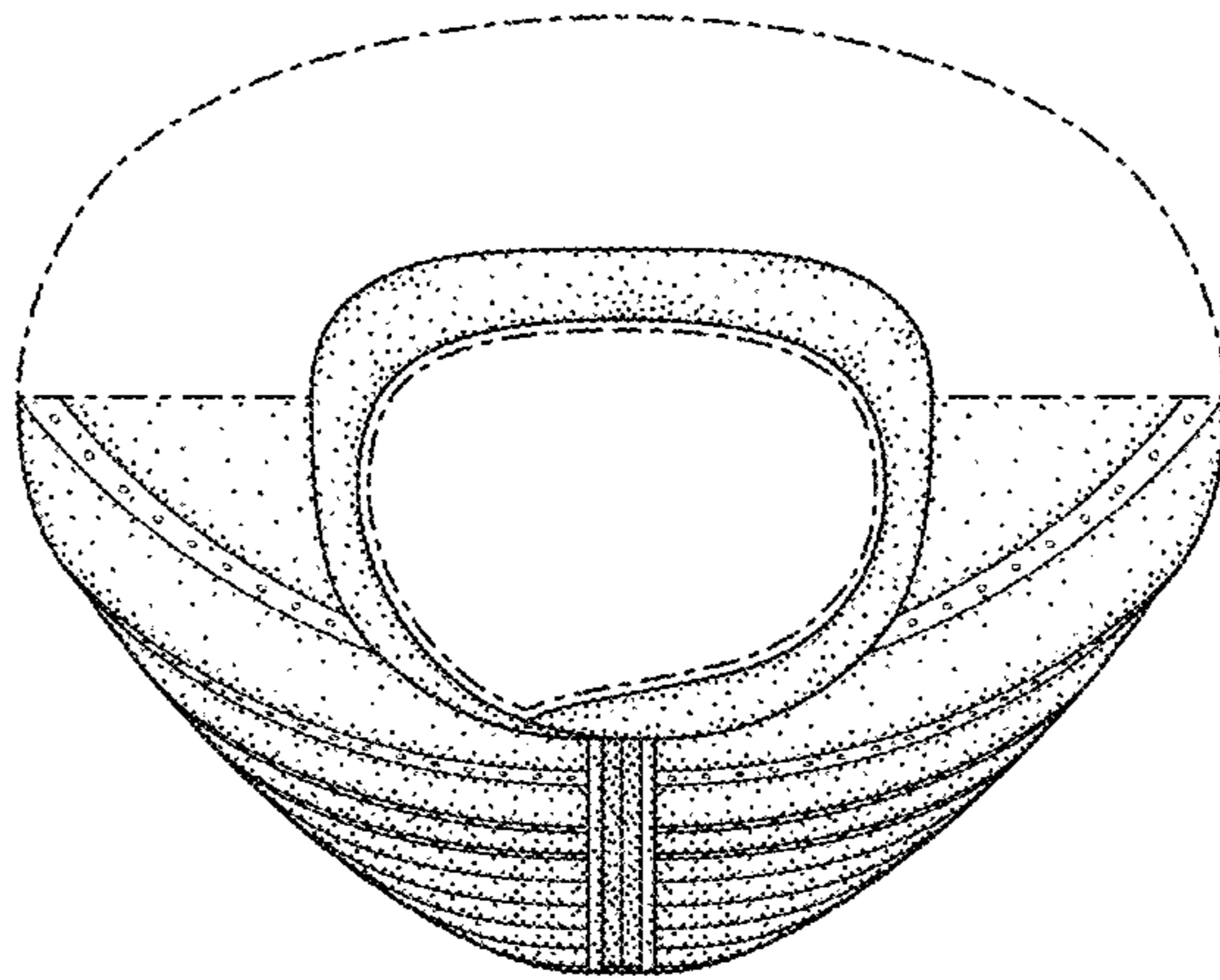

FIG. 6

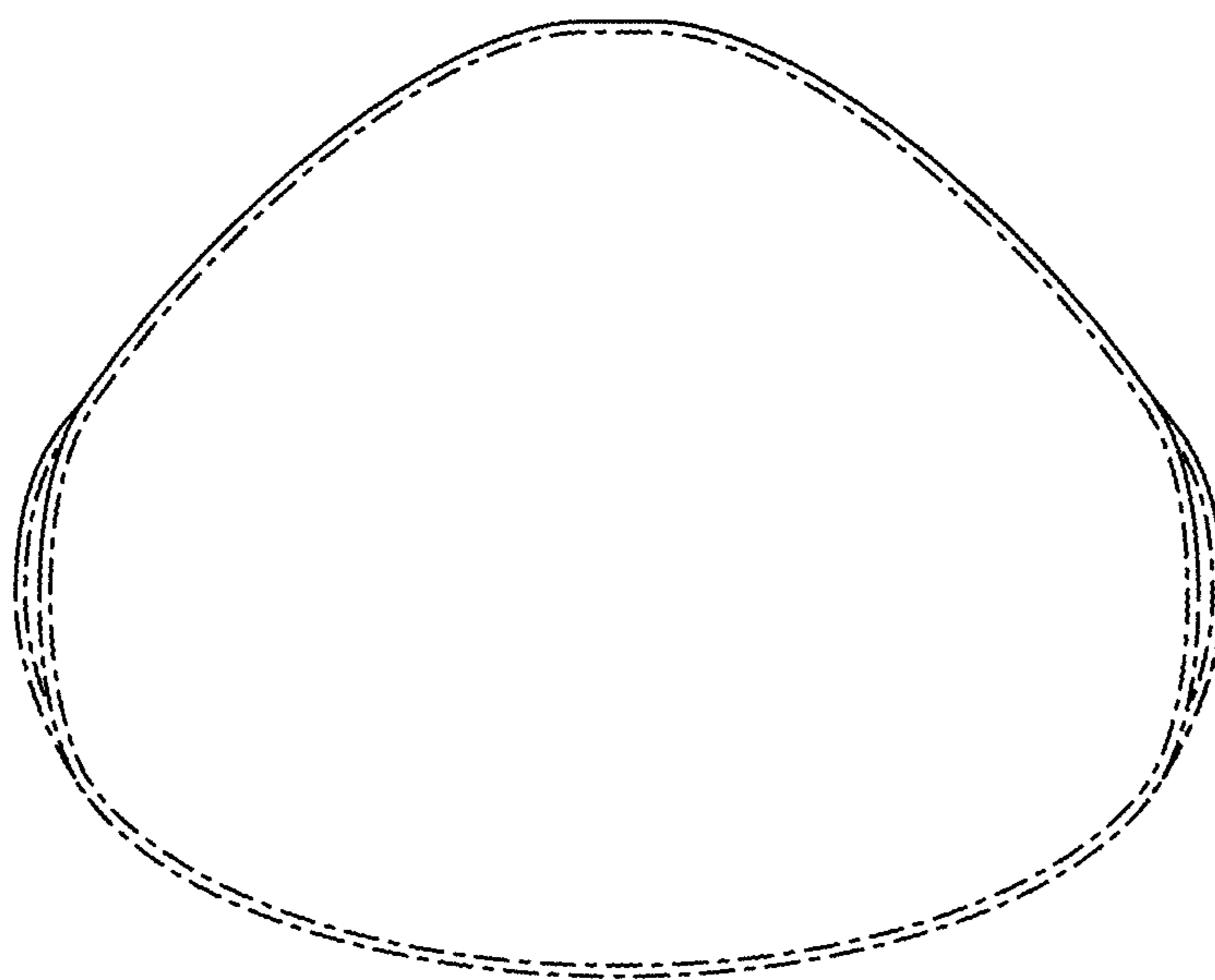

FIG. 7