



US00D791415S

(12) **United States Design Patent**
Morgante

(10) **Patent No.:** **US D791,415 S**

(45) **Date of Patent:** **** Jul. 4, 2017**

- (54) **STIRRUP**
- (71) Applicant: **INTELLIGENT INVENTIONS LIMITED**, Brisbane (AU)
- (72) Inventor: **Adrian Morgante**, Brisbane (AU)
- (73) Assignee: **Intelligent Inventions Limited**, Brisbane (AU)

(**) Term: **14 Years**

(21) Appl. No.: **29/524,987**

(22) Filed: **Apr. 24, 2015**

(30) **Foreign Application Priority Data**

Oct. 30, 2014 (AU) 201415468

(51) **LOC (10) Cl.** **30-04**

(52) **U.S. Cl.**
USPC **D30/142**

(58) **Field of Classification Search**
USPC D30/134–142
CPC B68C 3/00; B68C 1/16; B68C 3/02; B68C
2003/0041; B68C 2003/0025; B68C
2003/0083

See application file for complete search history.

(56) **References Cited**

U.S. PATENT DOCUMENTS

- 3,905,179 A * 9/1975 Bischeltsrieder B68C 3/00
54/47
- D339,665 S * 9/1993 Nishimoula D30/142
- D383,572 S * 9/1997 Rea D30/142
- D411,667 S * 6/1999 Martin D30/142
- D415,594 S * 10/1999 Bostock D30/142
- D593,261 S * 5/2009 Nishimura D30/142
- D608,955 S * 1/2010 Baumann D30/142
- 2005/0005581 A1 * 1/2005 Chang B68C 3/00
54/48

- 2005/0081493 A1 * 4/2005 Chang B68C 3/00
54/48
- 2006/0096256 A1 * 5/2006 Chang B68C 3/00
54/48
- 2008/0196363 A1 * 8/2008 Chang B68C 3/00
54/49
- 2013/0305666 A1 * 11/2013 Calza B68C 3/00
54/47

(Continued)

Primary Examiner — George D Kirschbaum

Assistant Examiner — Jennifer Watkins

(74) *Attorney, Agent, or Firm* — Klein, O'Neill & Singh, LLP

(57) **CLAIM**

The ornamental design for a stirrup, as shown and described.

DESCRIPTION

FIG. 1 is a perspective view, taken from the front, top, and right side, of a stirrup, in accordance with my new design; FIG. 2 is a front elevation view of the stirrup shown in FIG. 1; FIG. 3 is a rear elevation view of the stirrup shown in FIG. 1; FIG. 4 is a side elevation view of the stirrup shown in FIG. 1, taken from the right side of FIG. 1; FIG. 5 is a side elevation view of the stirrup shown in FIG. 1, taken from the left side of FIG. 1; FIG. 6 is a top plan view of the stirrup shown in FIG. 1; FIG. 7 is a bottom plan view of the stirrup shown in FIG. 1; and, FIG. 8 is a perspective view, taken from the rear, top, and left side, of the stirrup shown in FIG. 1.

The broken lines in the figures illustrate portions of the article that form no part of the claimed design. The broken line showing of textured surface features on the top of the stirrup are for the purpose of illustrating portions of the article and form no part of the claim.

1 Claim, 7 Drawing Sheets

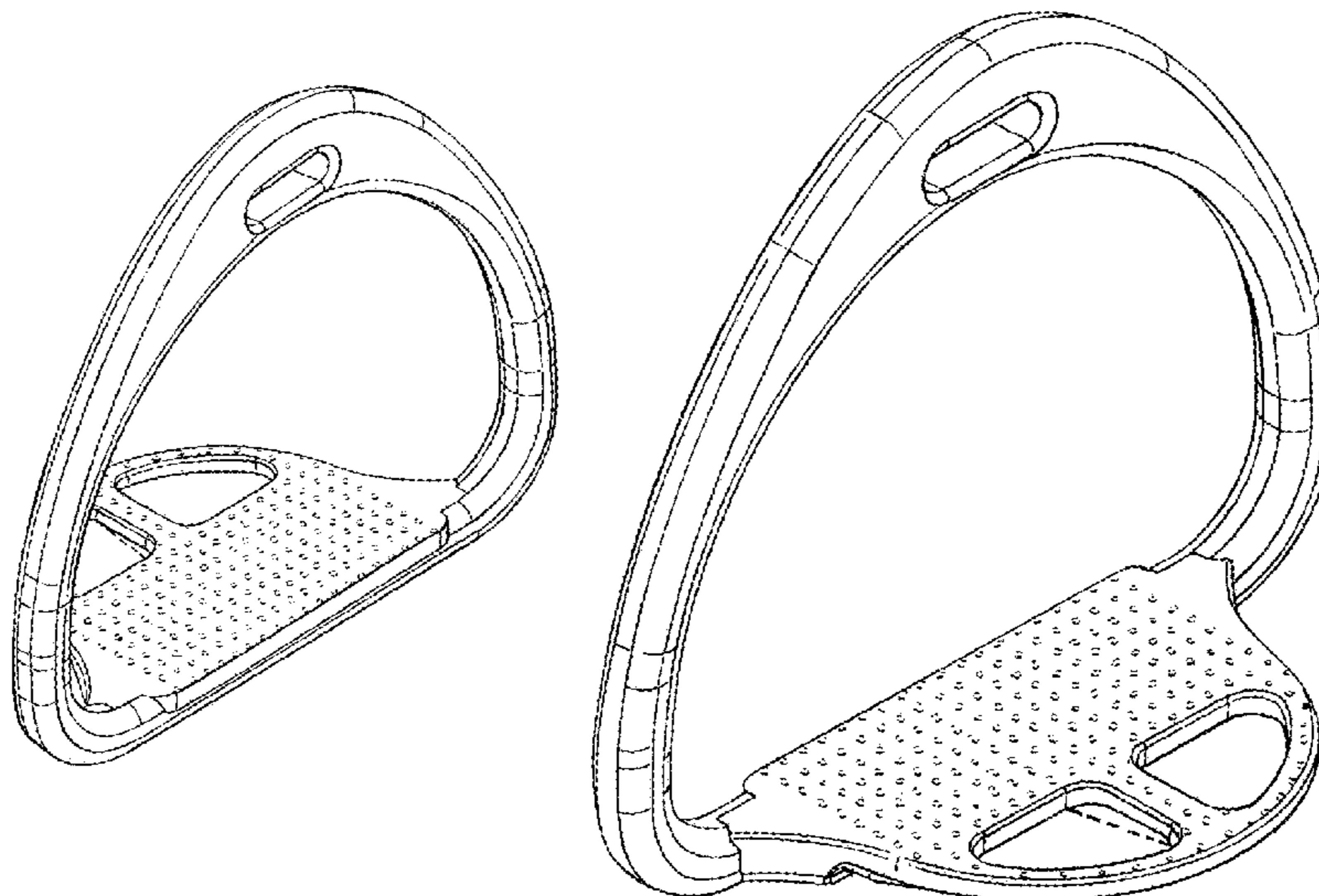

(56)

References Cited

U.S. PATENT DOCUMENTS

2016/0046481 A1 * 2/2016 Benetti B68C 3/00
54/47

* cited by examiner

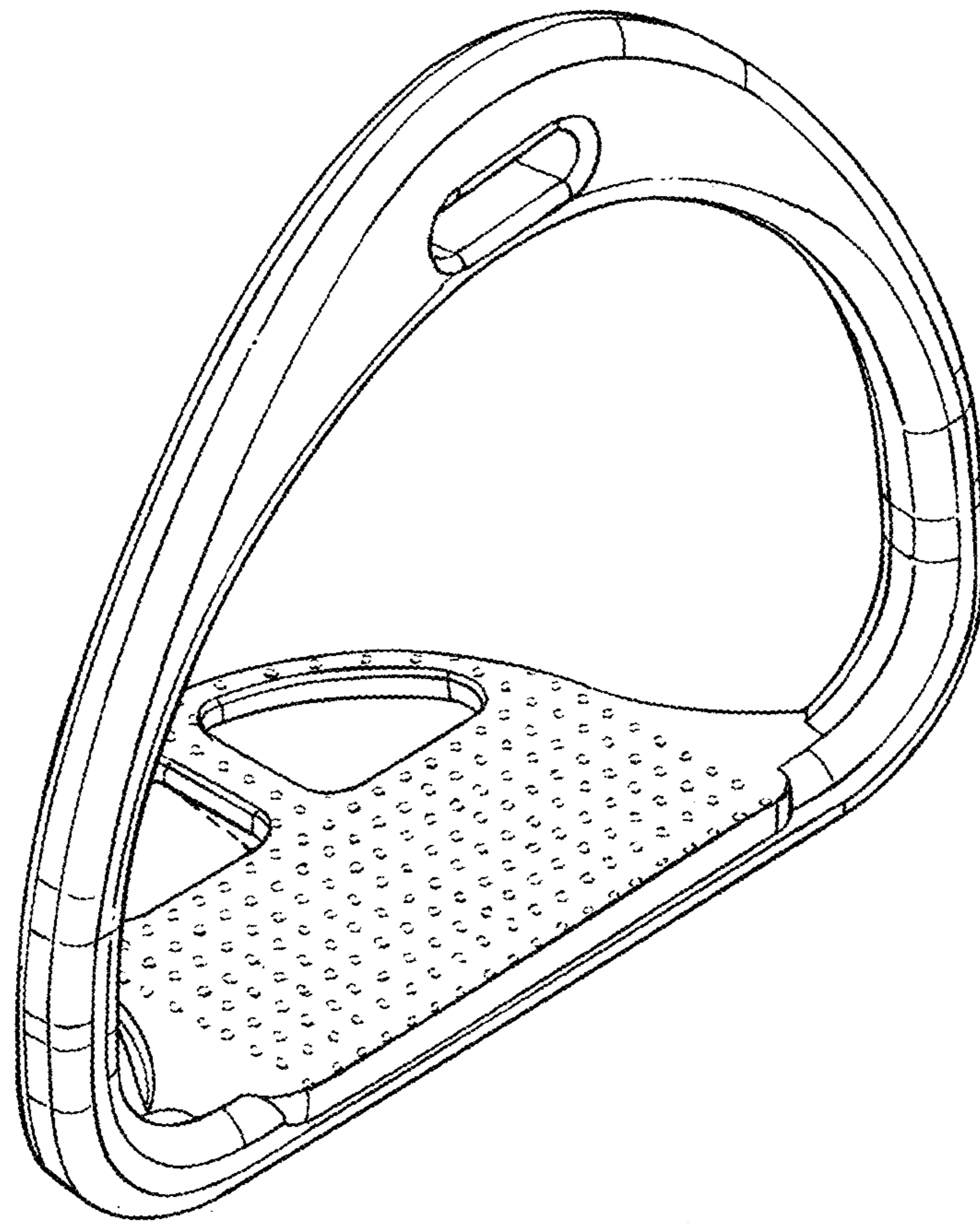

FIG. 1

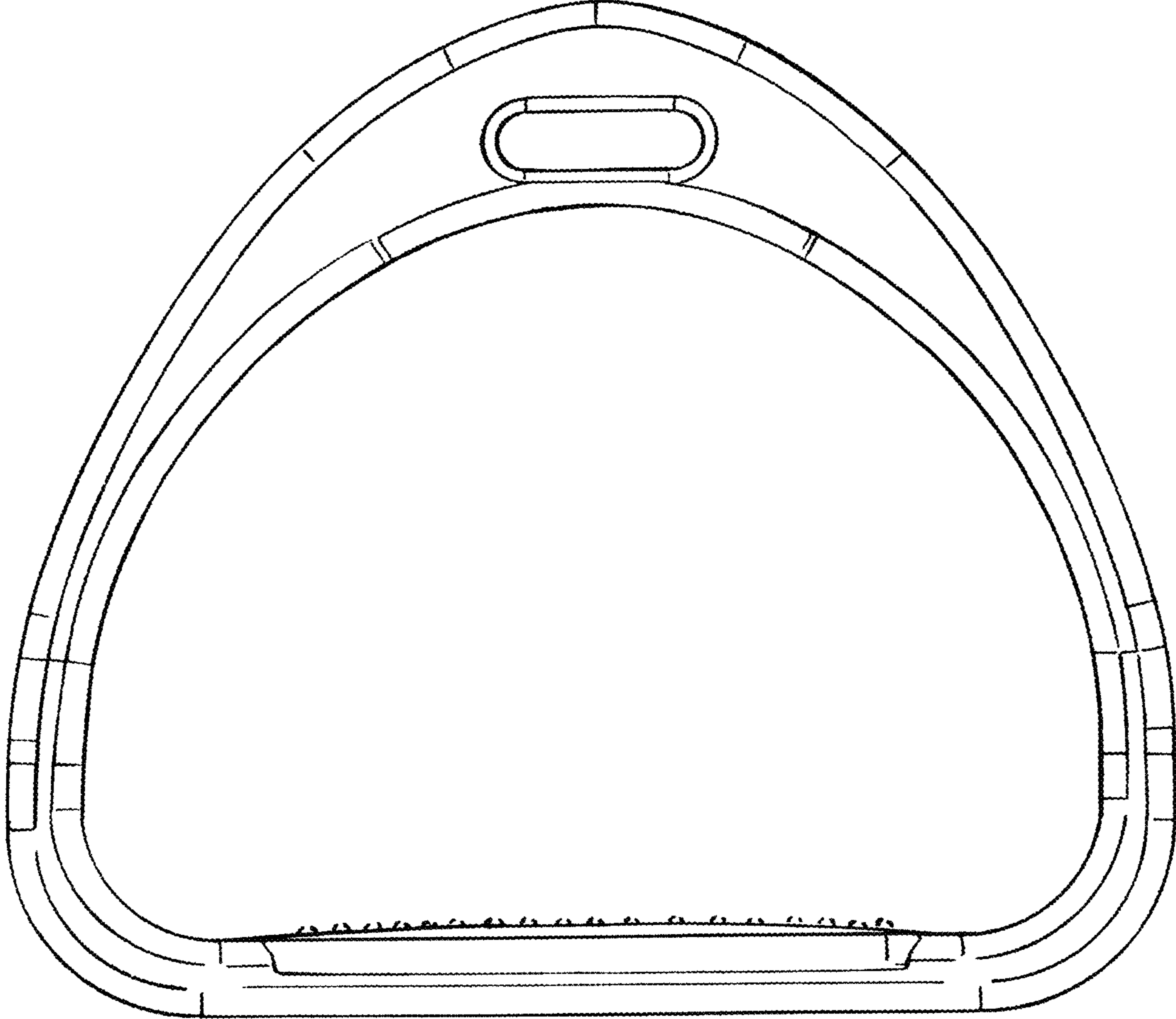

FIG. 2

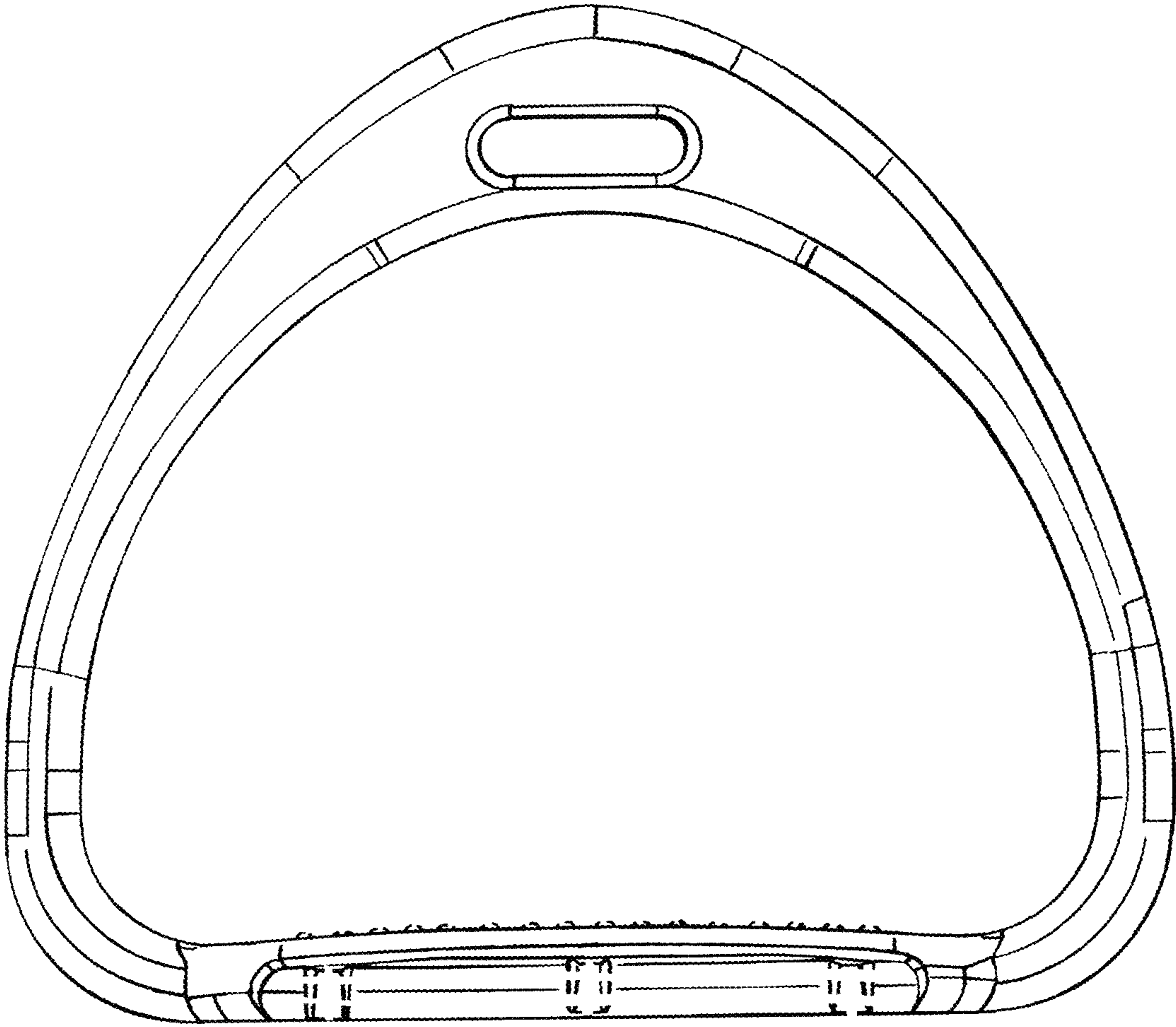

FIG. 3

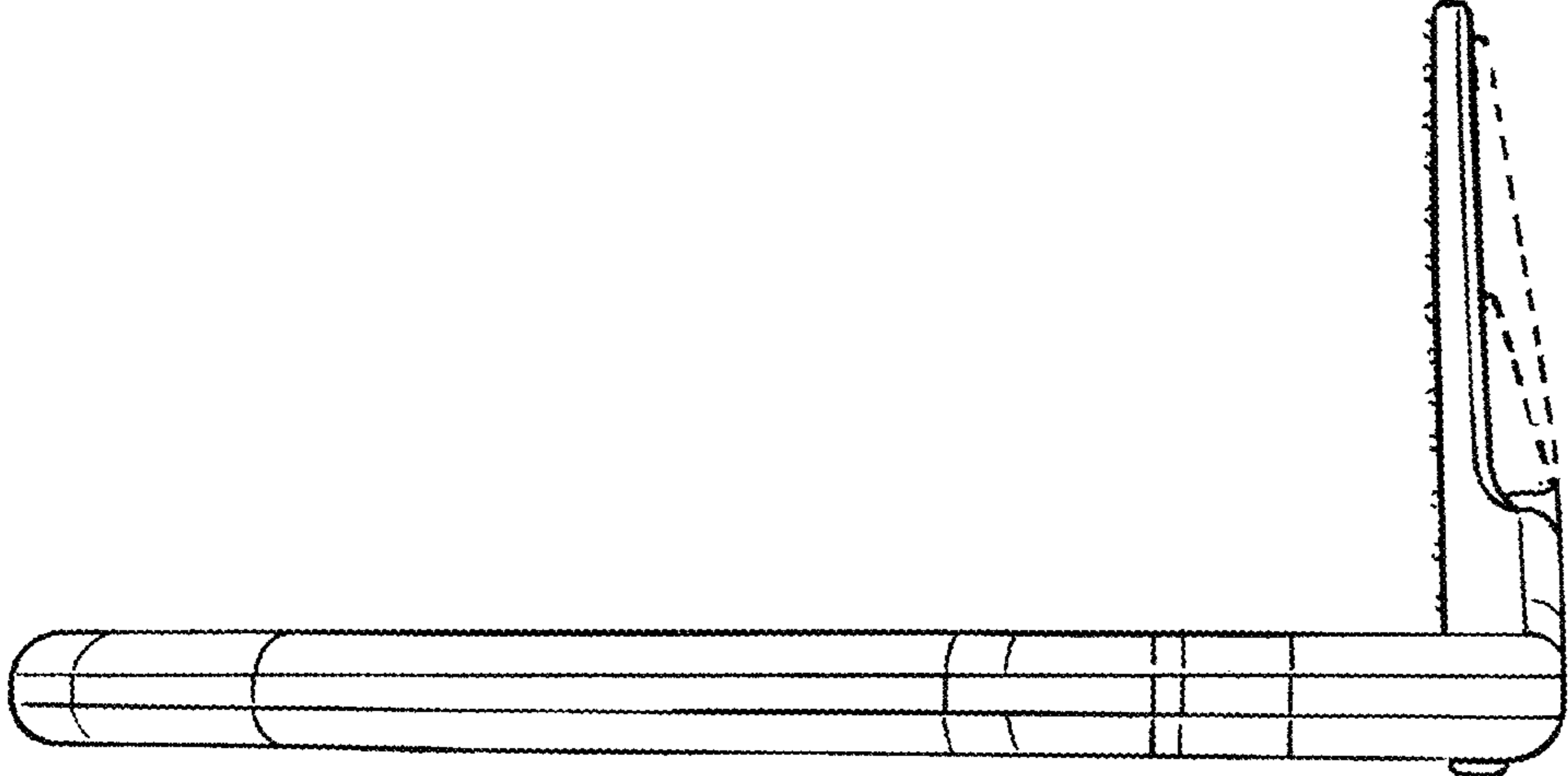

FIG. 5

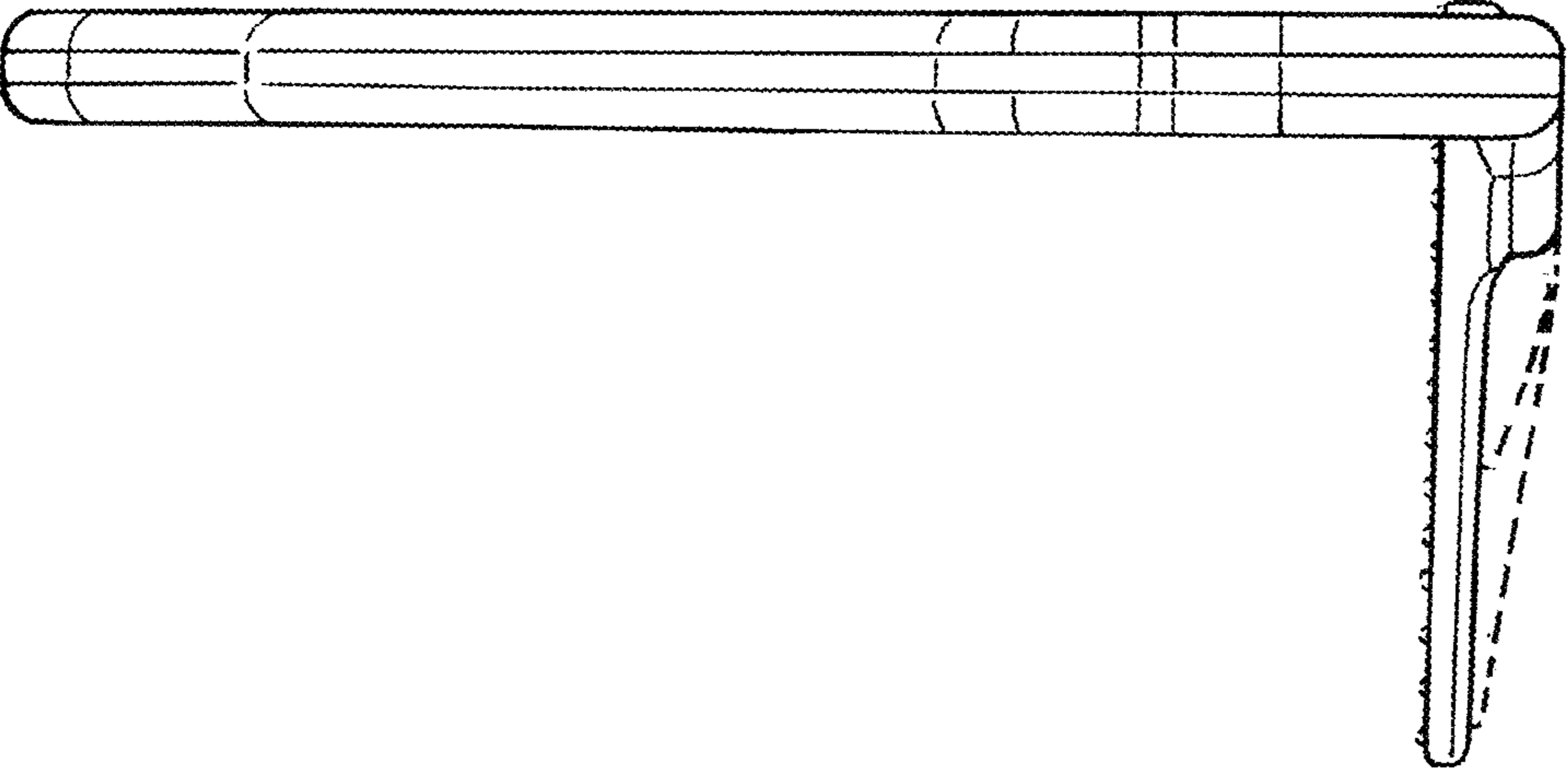

FIG. 4

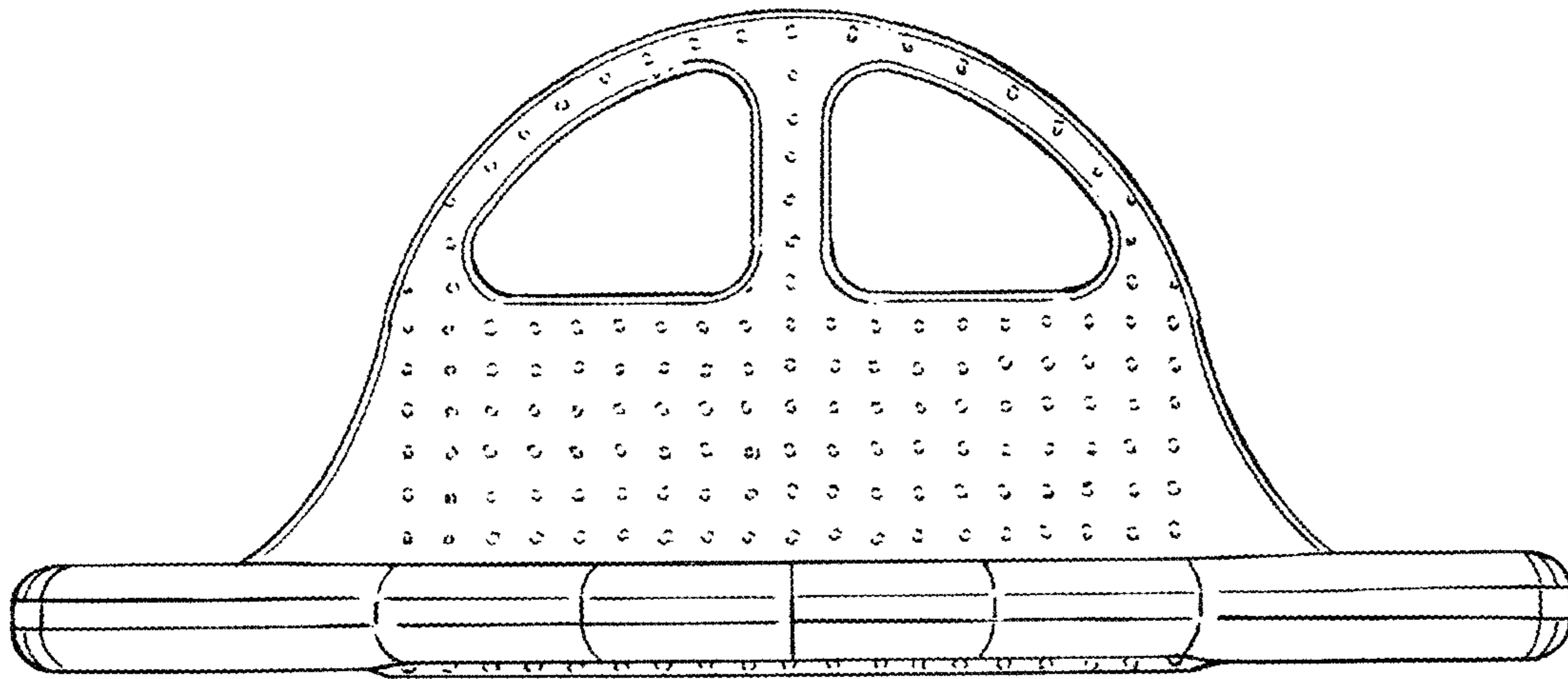

FIG. 6

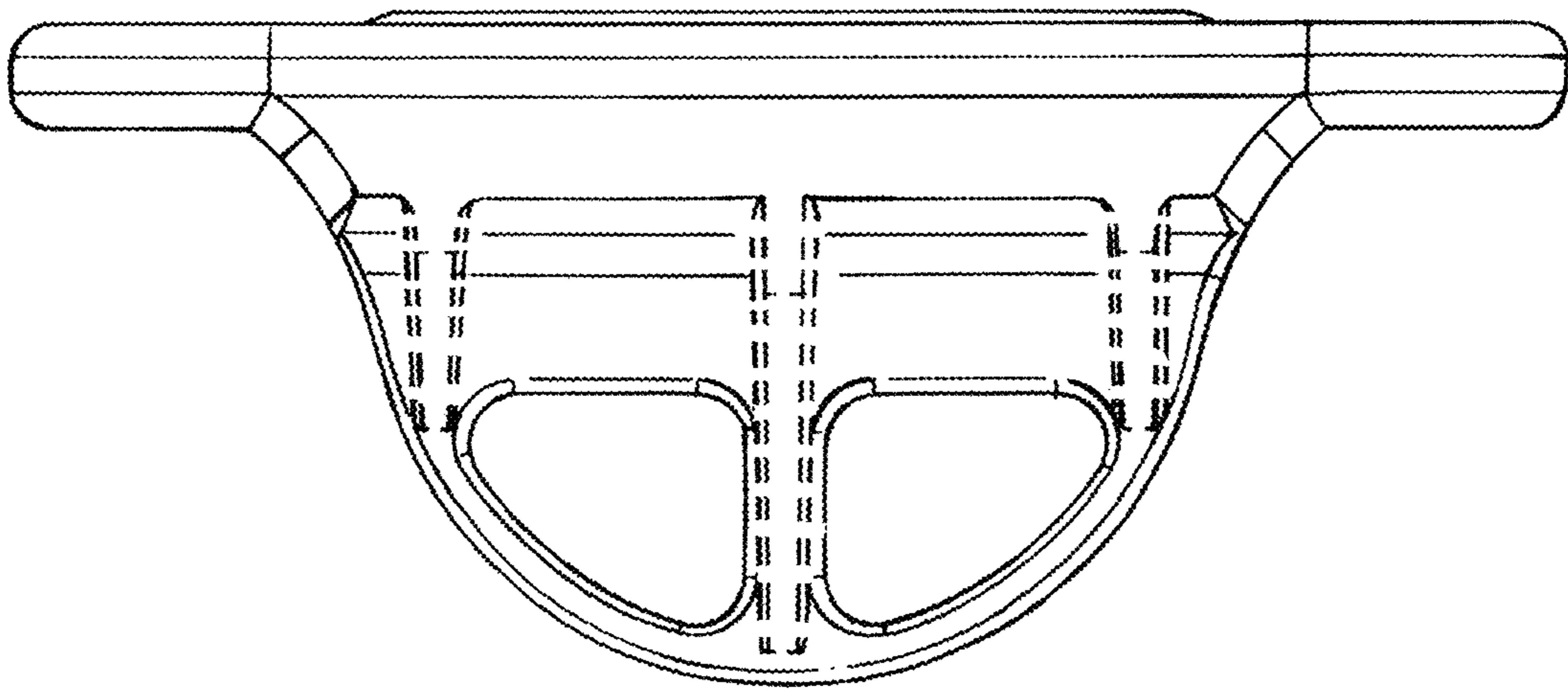

FIG. 7

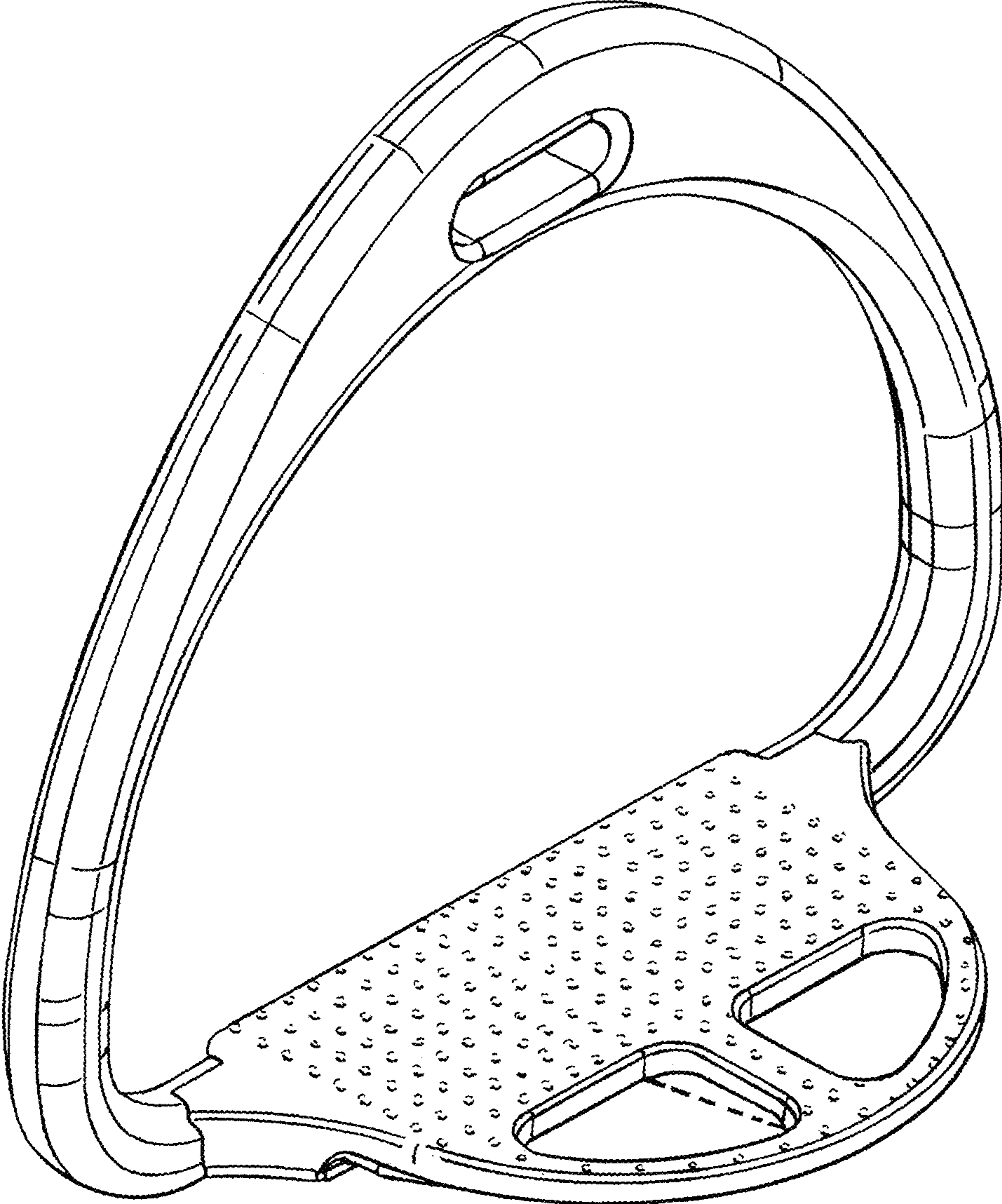

FIG. 8